



User's Manual for

THE FT SERIES

Floor Standing, Modulating
Gas, Condensing, Combination Boiler

Model FTCF199N
199,000 BTU/h



- Natural Gas (NG) - Factory Configuration
- Propane Gas (LP) - Field-Convertible

FOR YOUR SAFETY: This product must be installed and serviced by a professional service technician, qualified in hot water boiler and heater installation and maintenance. Improper installation and/or operation could create carbon monoxide gas in flue gases which could cause serious injury, property damage, or death. Improper installation and/or operation will void the warranty.

⚠ WARNING

If the information in this manual is not followed exactly, a fire or explosion may result causing property damage, personal injury or loss of life.

Do not store or use gasoline or other flammable vapors and liquids in the vicinity of this or any other appliance.

WHAT TO DO IF YOU SMELL GAS

- Do not try to light any appliance.
- Do not touch any electrical switch; do not use any phone in your building.
- Immediately call your gas supplier from a nearby phone. Follow the gas supplier's instructions.
- If you cannot reach your gas supplier, call the fire department.

Installation and service must be performed by a qualified installer, service agency, or gas supplier.

⚠ AVERTISSEMENT

Assurez-vous de bien suivre les instructions données dans cette notice pour réduire au minimum le risque d'incendie ou d'explosion ou pour éviter tout dommage matériel, toute blessure ou la mort.

Ne pas entreposer ni utiliser d'essence ou ni d'autres vapeurs ou liquides inflammables dans le à proximité de cet appareil ou de tout autre appareil.

QUE FAIRE SI VOUS SENTEZ UNE ODEUR DE GAZ:

- Ne pas tenter d'allumer d'appareils.
- Ne touchez à aucun interrupteur. Ne pas vous servir des téléphones dans le bâtiment où vous vous trouvez.
- Appelez immédiatement votre fournisseur de gaz depuis un voisin. Suivez les instructions du fournisseur.
- Si vous ne pouvez rejoindre le fournisseur de gaz, appelez le service des incendies.

L'installation et l'entretien doivent être assurés par un installateur ou un service d'entretien qualifié ou par le fournisseur de gaz.

CONTENTS	Pgs -
1. Familiarizing yourself to the FT	2
2. Caring For Your FT	2
3. Start Up and Shut Down.	4
4. Control Display and Operation	4-10

1. Familiarizing yourself to

THE FT

The FT is a floor standing, condensing and fully modulating, residential boiler and water heater.

This Users Manual will guide you into the basics of operating your FT floorstanding boiler.

Please reference the Installation and Operation Manual for complete details (Doc 1505).

2. Caring For Your FT

Your FT will require very little maintenance. However, as with any fine appliance, there are certain steps that should be taken to ensure continuing optimum performance.

2.1 General Care

Keep the area around the FT clean and free from combustible materials, gasoline and other flammable liquids and vapors.

The FT must be completely isolated and protected from any source of corrosive chemical fumes such as trichlorethylene, perchlorethylene, chlorine, etc.

Keep openings on the boiler free for proper ventilation of interior components.

Do not obstruct or block a free flow of air to the boiler to ensure proper ventilation.

If desired, clean the jacket surfaces with a damp cloth and mild detergent. Do not use flammable cleaning materials.

If sidewall vented, keep the vent terminal clear of obstructions — do not allow snow to cover the vent terminal. Clean the intake screen often, and then develop an appropriate maintenance schedule.

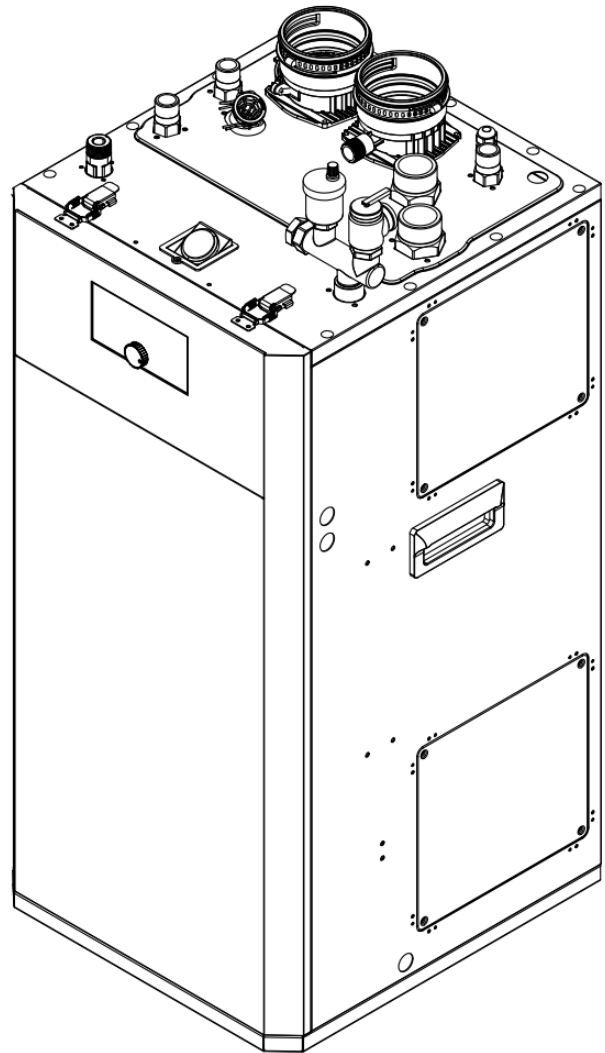

2.2 Annual Inspection of Flue and Vents

Visually inspect the vent pipe once a year. Should any deterioration exist, have the affected parts replaced by a qualified service person.

2.3 In the Event of a Power Failure

The FT can not be operated during an electrical power outage. If there is an extended power outage with danger from freezing, then the FT (and all other water systems) should be drained completely. When draining this combi boiler, turn off main electrical disconnect switch. When placing back in service, refer to Section 3 of this Manual for instruction. All draining and filling must only be done by a qualified service person.

2.4 Full Service Every Year

In addition to the annual visual inspections, a qualified service agency should conduct a detailed inspection of all flue product carrying areas of the boiler and its venting system.

Names of Components

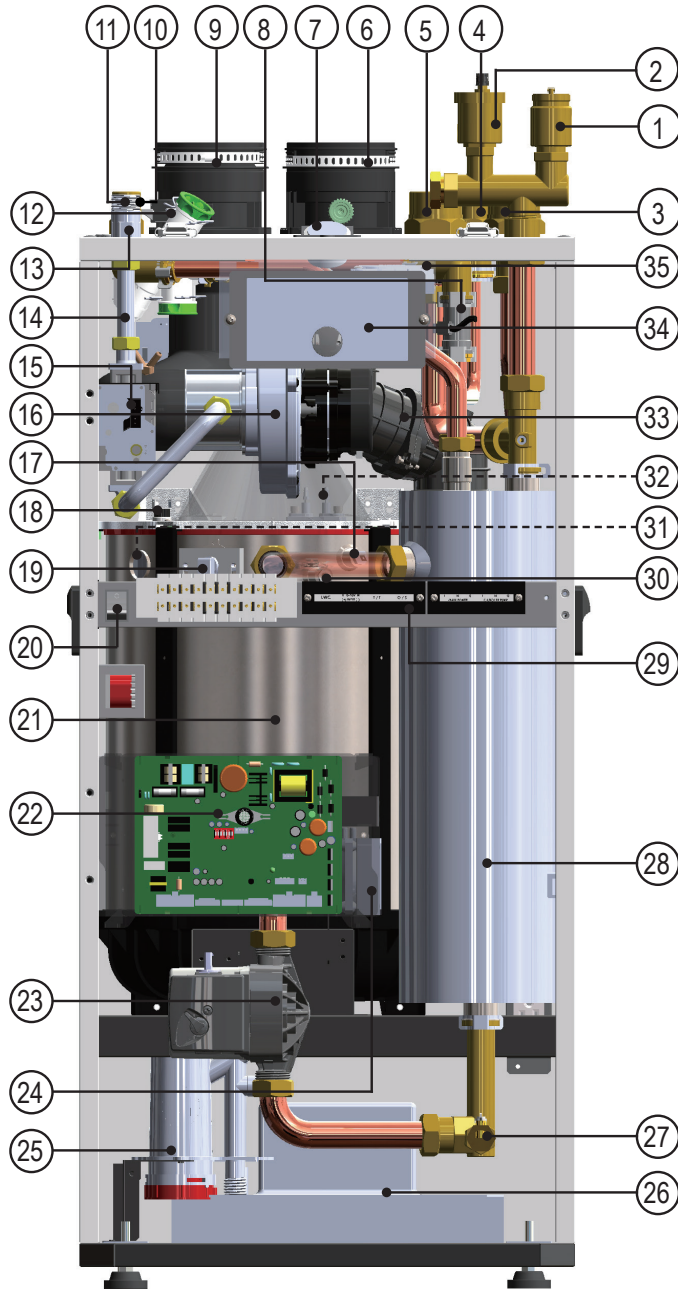

#	Name of Component
1	Pressure Relief Valve
2	Air Vent (air eliminator)
3	Boiler Return Connection
4	DHW Recirculation Connection
5	Boiler Supply Connection
6	Vent Pipe Collar
7	Boiler Pressure Gauge
8	Cold Water Flow Sensor
9	Air Intake Collar
10	DHW Inlet Connection
11	DHW Outlet Connection
12	DHW Filter and Flow Restrictor
13	Gas Inlet Adapter
14	Air Gas Mixing Pipe
15	Gas Valve
16	BLDC Fan (Blower)
17	Low Water Cut Off
18	Burner High Limit Switch
19	Flame Detecting Sensor
20	Manual Power Switch (ON / OFF)
21	Heat Exchanger
22	Main PCB
23	Boiler Pump
24	Blocked Condensate Switch
25	Condensate Trap
26	Condensate neutralizer and Drain pump (optional equipment)
27	Drain Valve
28	Low Loss Header and DHW Coil
29	Terminal Block
30	Overheat Temperature Sensor
31	Sight Glass
32	Igniter
33	Exhaust Pipe
34	Control Panel and Display
35	Air Pressure Sensor

3. Shut Down and Restart

3.1 To Start the FT

If drained, please refer to the Install and Operating Manual to ensure that the complete 'Setup' procedure has been followed before starting this boiler. A complete 'Setup' must be performed by a qualified service person.

3.2 Shutting Down the FT

1. Turn off the main electrical disconnect switch.
2. Close all manual gas valves.
3. If freezing is anticipated, drain the FT and be sure to also protect the building piping from freezing. All water must be removed from heat exchanger and condensate trap or else damage from freezing may occur. Please refer to the Install and Operating Manual. This step to be performed by a qualified service person.

4. The Control Display and Operation

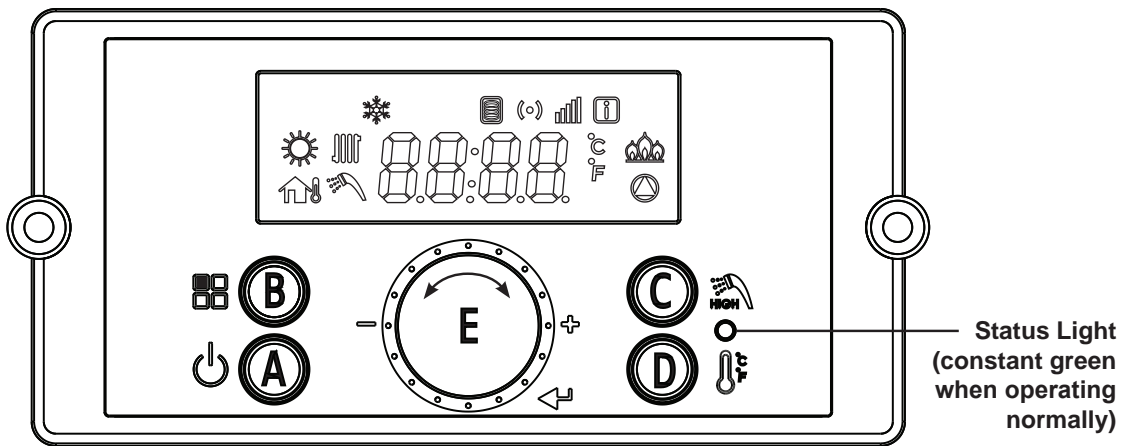

The Control Display has a Control Dial (E), 4 buttons (A, B, C, D), and a Liquid Crystal Display (with 72 back-lit segments). This section of this manual gives instruction on how to navigate into the many functions of the FT and to change temperature set points, set system variables and controller parameters.

Buttons			Functionality	
			PRESS (Tap)	PRESS and HOLD (5 seconds)
A		Display Power	Turns Control Display ON/OFF	
B		Modes	Tap to return to menu	(If Display Power was On) Status Display Mode (If Display Power was Off) Installer Mode
C		Hot Water	DHW Set-Point LOW Range 95 - 120°F (35 - 49°C)	DHW Set-Point HIGH Range 121 - 140°F (49.5 - 60°C)
D		Central Heat	CH set-point mode (boiler only)	Toggle (°C / °F)
E		Scroll / Select	Turn to scroll, tap to select (clockwise or counterclockwise)	

- Temperature Specifications
Operating ambient Temperature Range : 14F - 140°F (-10 to 60°C).
- Operating Relative Humidity up to: 90% at 104°F (40°C).
- Shipping & Storage Temperature Range of : -4F - 176°F (-20 to 80°C).

4. The Control Display and Operation (continued)

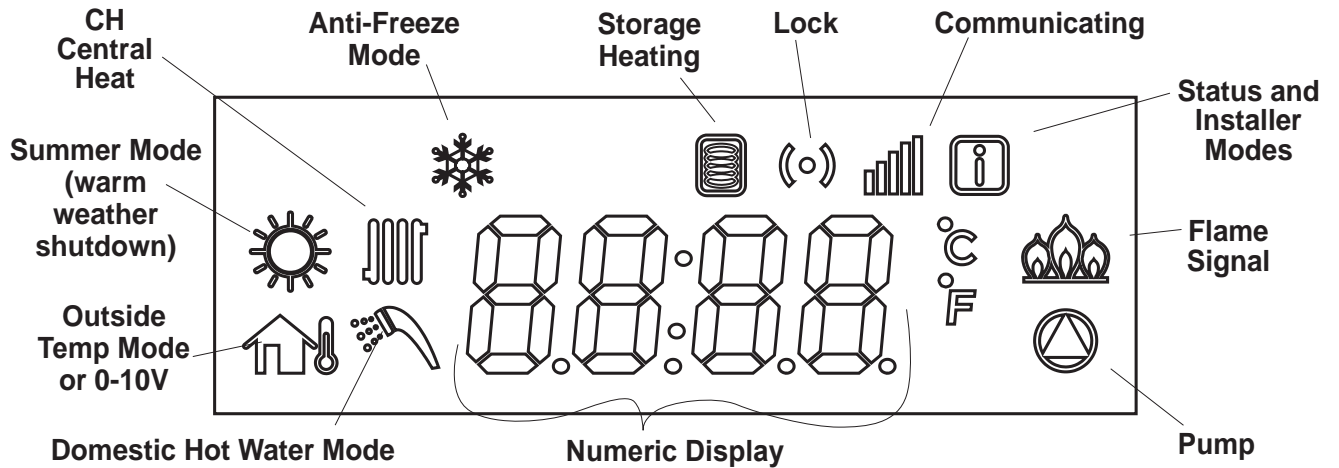

CH mode	Central Heat mode icon can be adjusted
Anti-freeze mode	Anti-freeze mode icon
Storage Heating mode	Stored Water Being Heated, can be adjusted
Lock mode	Buttons-locked mode icon
Communication	Communication icon
Summer mode	Only DHW Mode, can be adjusted (warm weather shutdown)
Status and Installer mode	The Status Mode or the Installer Mode is Active (all parameters)
Flame signal	Flame Signal icon
Pump icon	Water pump operation (CH or DHW) icon
Numeric Display	Number and character display, to display all parameters
DHW mode	Combination boiler Set Point, can be adjusted
Outside temp or 0-10 V mode	Operating by outside temperature or 0-10V

The LCD will illuminate when a user action is detected (a button is pressed) and will turn back off after 20 seconds.

* NOTE: The display will not allow changes when the lock mode (Ⓚ) is activated.

To exit the Lock mode, press the  button.





 **WARNING**

Do not use this appliance if any part has been under water. Immediately call a qualified service technician to inspect the appliance and to replace any part of the control system and any gas control that may have been under water.

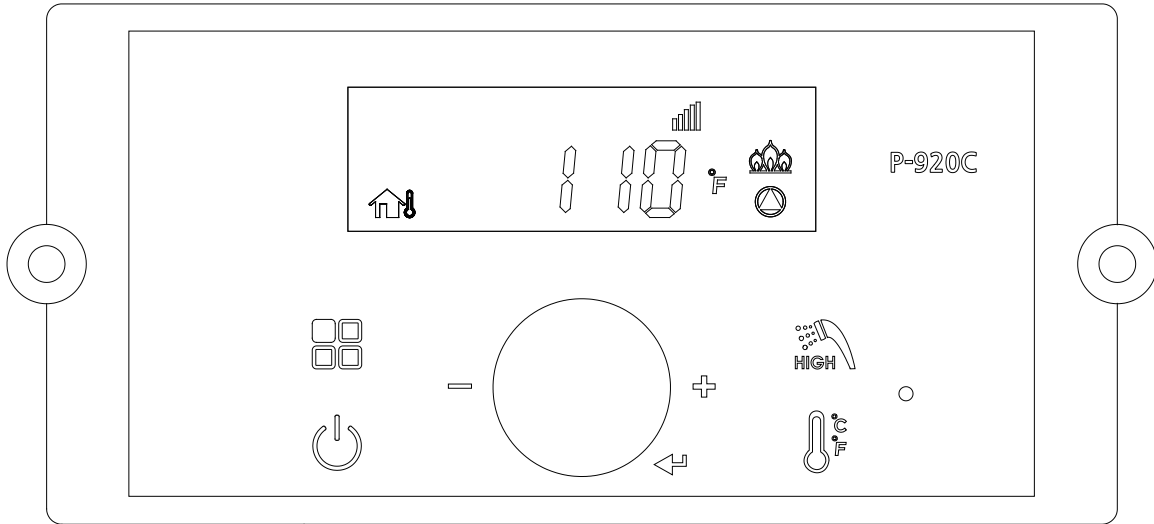
▪ **Operating Mode**

After the Power is turned on, and/or the Control Display is turned on , the Control Display will go through a 'Start Up' checklist and briefly show a sequence of diagnostic codes before entering into the 'Operating Mode'. It will then display the following information.



Indicate	Example
Current Operating Temperature	110°F
Temperature sign Celsius or Fahrenheit letter	°C or °F
Display and Controller are communicating	
If flame detected	
If pump is operating	
Outdoor sensor or 0-10V	

Note: The house symbol will blink when the outdoor sensor is not connected to the boiler.

Status Display Mode

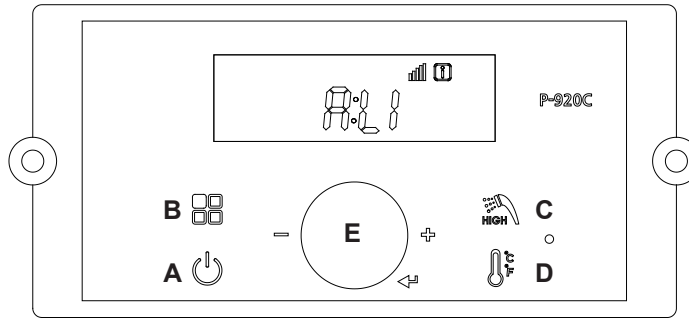

1. STATUS DISPLAY MODE (When button  is pressed for 5 seconds When power to display panel is ON , status display will be activated)

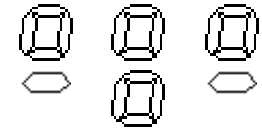
Digital Display	Status Display Parameter	Description	
O:ot	Outdoor temperature (when --- is displayed, no outdoor sensor is connected)	Current outdoor sensor temperature	
A: Li or A: GA	DHW Flow Rate	Current DHW Flow(Li: L/m, GA: GPM)	
b: It	CH Return Water Temperature	Current Return Water Sensor Temperature	
C: Fr	Fan rpm	Current FAN speed (RPM)	
d: Lc	Lock mode	Lock mode ON/OFF	
E: oP	CH supply temperature (Operating temperature)	Current Boiler Supply temperature	
F: dH	DHW temperature (Operating temperature)	Current DHW temperature	
H: Eh	Exhaust gas temperature	Current exhaust gas temperature	
I : St	DHW Recirculation temperature (when 0 F is displayed, no DHW Recirc sensor is connected)	Current DHW Recirc water temperature	
J: oH	CH Overheat Temperature	Current CH Overheat Temperature	
L: rt	1: PH	Time for supply power	Unit : 1000hour
	2: rh	Time for burner operation	Unit : 1hour
	3: rH	Time for burner operation	Unit : 1,000hour
	4: It	Cycle for ignition	Cycle: 10 times the displayed unit
	5: IH	Cycle for ignition	Cycle: 10,000 times the displayed unit
P: Ou	PUMP Operation	CP1 System PUMP	Current PUMP Operation (CP1) (CP2) (CP3)  All Activate CP2 activate
		CP2 Boiler PUMP	
		CP3 DHW Recirc PUMP	

To view any of the above listed Status Parameters,

Press and Hold Button B  to get into the Status Display Mode.

Rotate Dial E until you find the Parameter that you wish to view. Tap Dial E to enter that

Parameter. Adjust to the setting that you require and then press (tap) Dial E to save and to Exit.



DHW Set Point Change Mode

The display shows the following information when changing water heating temperature set points.

Changing between Celsius and Fahrenheit

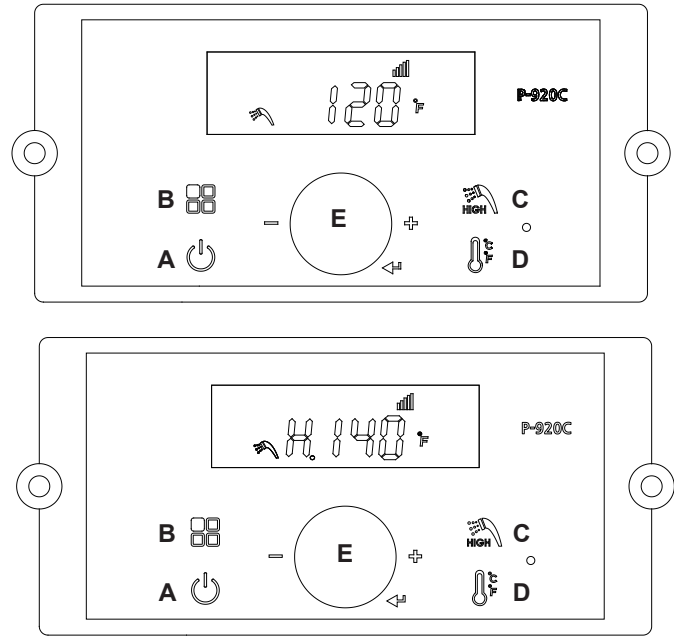
When the button D  is pressed (for more than 5 seconds), temperature unit will toggle between °C and °F.



Indicate	Example
Current DHW set point temperature	120°F
Temperature sign Celsius or Fahrenheit letter	°C or °F
If display is communicating with the main controller normally, the communication icon will be indicated.	
When DHW set point range is high : from 121°F (49.5°C) to 140°F (60.0°C)	H . 140°F
When changing DHW set point, the DHW icon will flash	

* Default DHW set point is 125°F (51.5°C)

• **DHW 95-120°F (35 - 49°C) LOW range (Default)**

-To change **LOW range**, press the C Button. The DHW icon and current DHW LOW will flash (a flashing value means it can be changed).

- Turn dial E clockwise to increase and counterclockwise to decrease until desired temperature is reached.
- Press dial E to save set point changes.

• **DHW 121 - 140°F (49.5 - 60°C) HIGH range**

-To change **HIGH range**, press and **HOLD** the C button for more than 5 seconds. The DHW icon and current DHW HIGH will flash (a flashing value means it can be changed).

- Turn dial E clockwise to increase and counterclockwise to decrease until desired temperature is reached.
- Press dial E to save set point changes and to Exit.





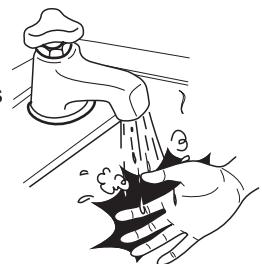

Scalding may occur within 5 seconds at a setting of 140°F (60°C). Water temperatures over 125°F can cause severe burns, or death from scalding. Children, disabled, and elderly are at highest risk of being scalded. Read all instructions before setting temperature at appliance. Feel water before bathing or showering.

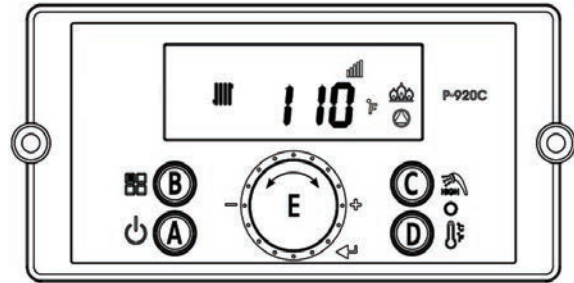

CH Set Point Change Mode

Changing between Celsius and Fahrenheit
 When the button D  is pressed (for more than 5 seconds), temperature unit will toggle between °C and °F.



Indicate	Example
Current Operating Temperature	110°F
Temperature sign Celsius or Fahrenheit letter	°C or °F
Display and Controller are communicating	
If flame detected	
If pump is operating	
When changing CH Setpoint, the CH Icon will flash	

Default CH set-point is 130°F (54°C)
 CH set-point range is 130 - 180°F (54.4 ~ 82.0°C)





To change CH Setpoint, press the button D  button. The CH Icon and current CH Setpoint will flash.

Turn the E dial clockwise to increase, and counterclockwise to decrease CH setpoint, until desired temperature is reached.

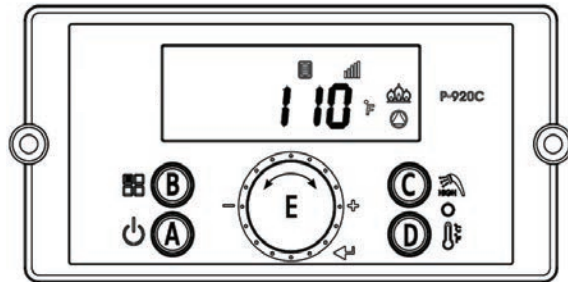
Press E dial to save changes and to Exit.

Storage Mode



Indicate	Example
Current Operating Temperature	110°F
Temperature sign Celsius or Fahrenheit letter	°C or °F
Display and Controller are communicating	
If flame detected	
Storage mode indication	
If Pump is operating	

To activate heat storage function, First turn OFF the power to the Control Display.

Then Press and Hold Button B  to get into the Installer Mode.

Rotate Dial E until you find **5:St** Tap Dial E to enter Storage Mode. Storage Mode indicates that the boiler is heating the water held in the internal storage tank. When Storage Mode is active, the display will appear as shown.

Turn the E dial clockwise to increase, and counterclockwise to decrease setting.

Press E dial to save changes and to Exit.

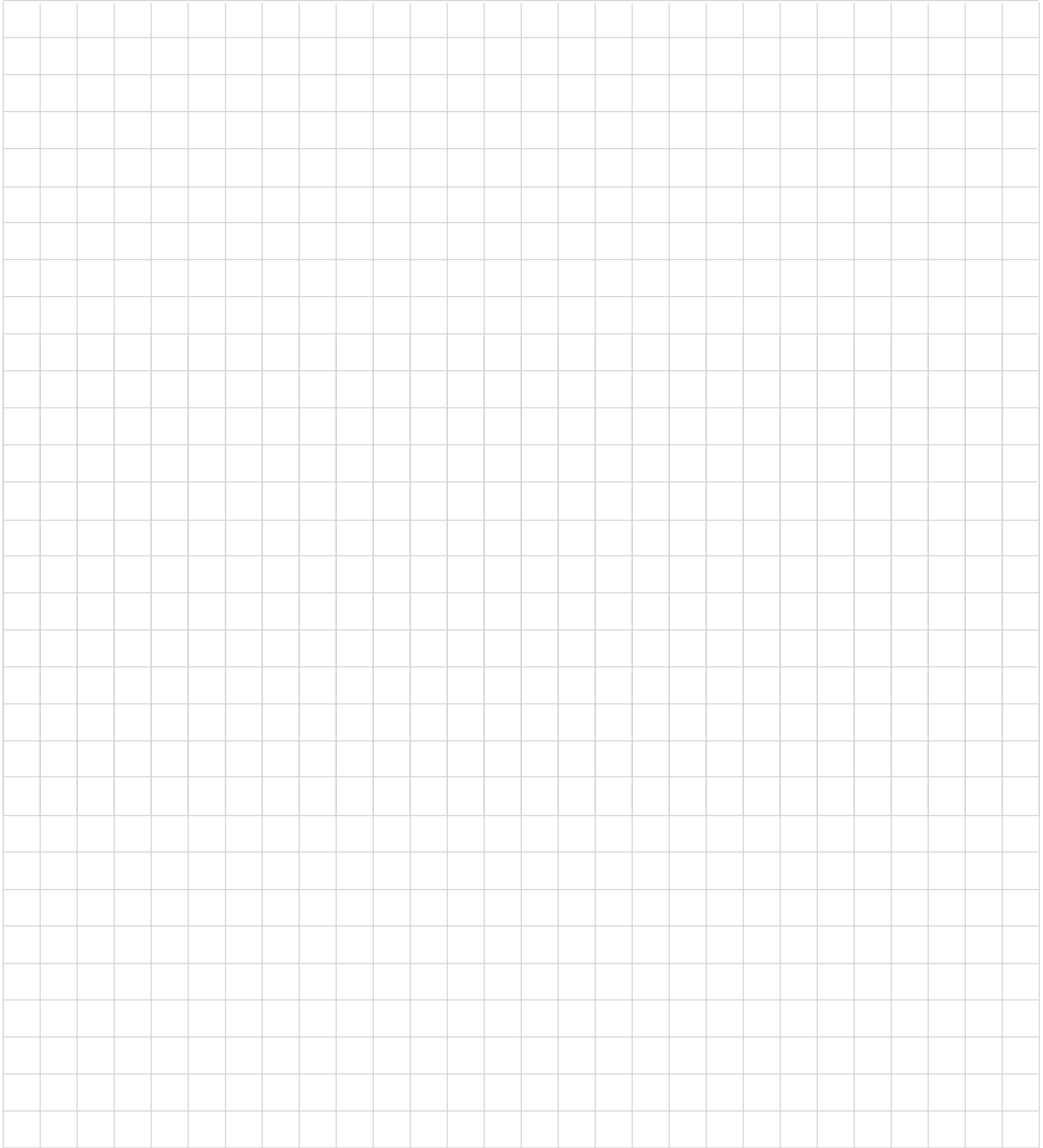

Dimensions and specifications subject to change without notice in accordance with our policy of continuous product improvement.

