



User's Manual

THE FT SERIES

Wall-Mounted, Modulating
Gas, Condensing, Combination Boiler

Model FTCW

140,000 BTU/h

199,000 BTU/h

- Natural Gas (NG) - Factory Configuration
- Propane Gas (LP) - Field-Convertible



FOR YOUR SAFETY: This product must be installed and serviced by a professional service technician, qualified in hot water boiler and heater installation and maintenance. Improper installation and/or operation could create carbon monoxide gas in flue gases which could cause serious injury, property damage, or death. Improper installation and/or operation will void the warranty.

⚠ WARNING

If the information in this manual is not followed exactly, a fire or explosion may result causing property damage, personal injury or loss of life.

Do not store or use gasoline or other flammable vapors and liquids in the vicinity of this or any other appliance.

WHAT TO DO IF YOU SMELL GAS

- Do not try to light any appliance.
- Do not touch any electrical switch; do not use any phone in your building.
- Immediately call your gas supplier from a nearby phone. Follow the gas supplier's instructions.
- If you cannot reach your gas supplier, call the fire department.

Installation and service must be performed by a qualified installer, service agency, or gas supplier.

⚠ AVERTISSEMENT

Assurez-vous de bien suivre les instructions données dans cette notice pour réduire au minimum le risque d'incendie ou d'explosion ou pour éviter tout dommage matériel, toute blessure ou la mort.

Ne pas entreposer ni utiliser d'essence ni d'autres vapeurs ou liquides inflammables dans le voisinage de cet appareil ou de tout autre appareil.

QUE FAIRE SI VOUS SENTEZ UNE ODEUR DE GAZ:

- Ne pas tenter d'allumer d'appareils.
- Ne touchez à aucun interrupteur. Ne pas vous servir des téléphones dans le bâtiment où vous êtes.
- Appelez immédiatement votre fournisseur de gaz depuis un voisin. Suivez les instructions du fournisseur.
- Si vous ne pouvez rejoindre le fournisseur de gaz, appelez le service des incendies.

L'installation et l'entretien doivent être assurés par un installateur ou un service d'entretien qualifié ou par le fournisseur de gaz.

.....CONTENTS	Pgs
1. Familiarizing yourself to the wall mounted FT Series Combi.....	2
2. Caring For Your FT Series Combi	2
3. Start Up and Shut Down.	4
4. Control Setup and Operation.....	4-10

1. Familiarizing yourself to

THE FT SERIES

The FT Series Combi is a wall mounted, condensing and fully modulating, residential boiler and water heater.

This User's Manual will guide you into the basics of operating your FT Series Combi.

Please reference the Installation and Operation Manual for complete details. Doc# 1487

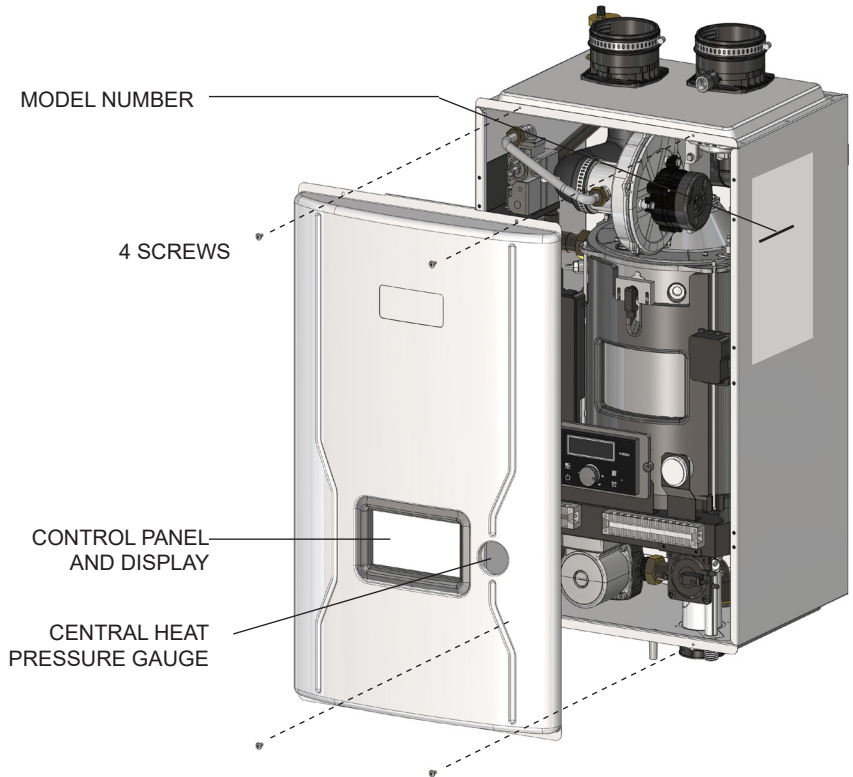

2. Caring For Your FT

Your FT Series Combi will require very little maintenance. However, as with any fine appliance there are certain steps that should be taken to ensure continuing optimum performance.

2.1 General Care

Keep the area around the FT Series Combi clean and free from combustible materials, gasoline and other flammable liquids and vapors.

The FT Series Combi must be completely isolated and protected from any source of corrosive chemical fumes such as trichlorethylene, perchlorethylene, chlorine, etc.

Keep bottom and top openings on the boiler free for proper ventilation of interior components.

Do not obstruct or block a free flow of air to the boiler to ensure proper ventilation.

If desired, clean the jacket surfaces with a damp cloth and mild detergent. Do not use flammable cleaning materials.

If sidewall vented, keep the vent terminal clear of obstructions — do not allow snow to cover the vent terminal. Clean the intake screen often, and then develop an appropriate maintenance schedule.

2.2 Annual Inspection of Flue and Vents

Visually inspect the vent pipe once a year. Should any deterioration exist, have the affected parts replaced by a qualified service person.

2.3 In the Event of a Power Failure

The FT Series Combi can not be operated during an electrical power outage. If there is an extended power outage with danger from freezing, then the FT Series Combi (and all other water systems) should be drained completely. When draining the boiler, turn off main electrical disconnect switch. When placing back in service, refer to Section 3 of this Manual for instruction. All draining and filling must only be done by a qualified service person.

2.4 Full Service Every Year

In addition to the annual visual inspections, a qualified service agency should conduct a detailed inspection of all flue product carrying areas of the FT Series Combi and its venting system.

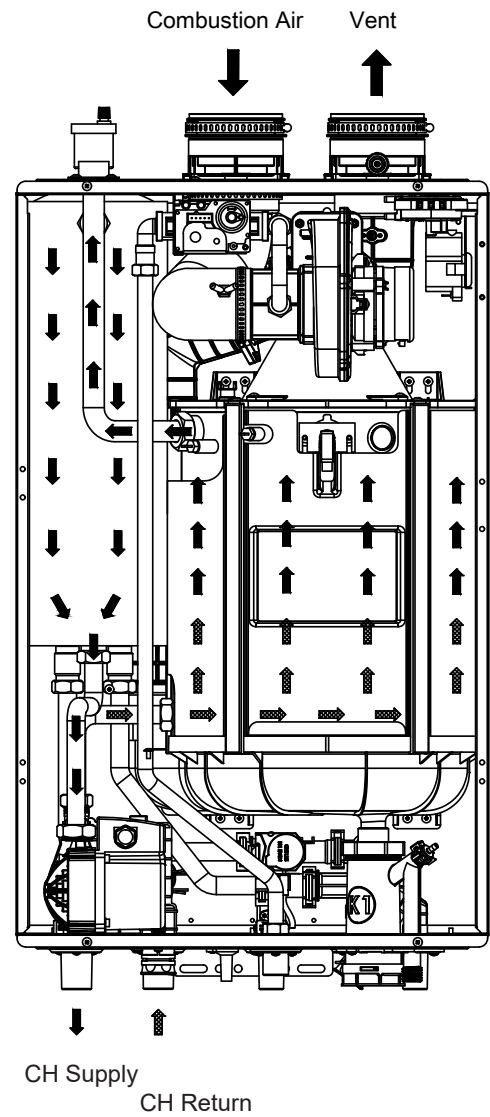
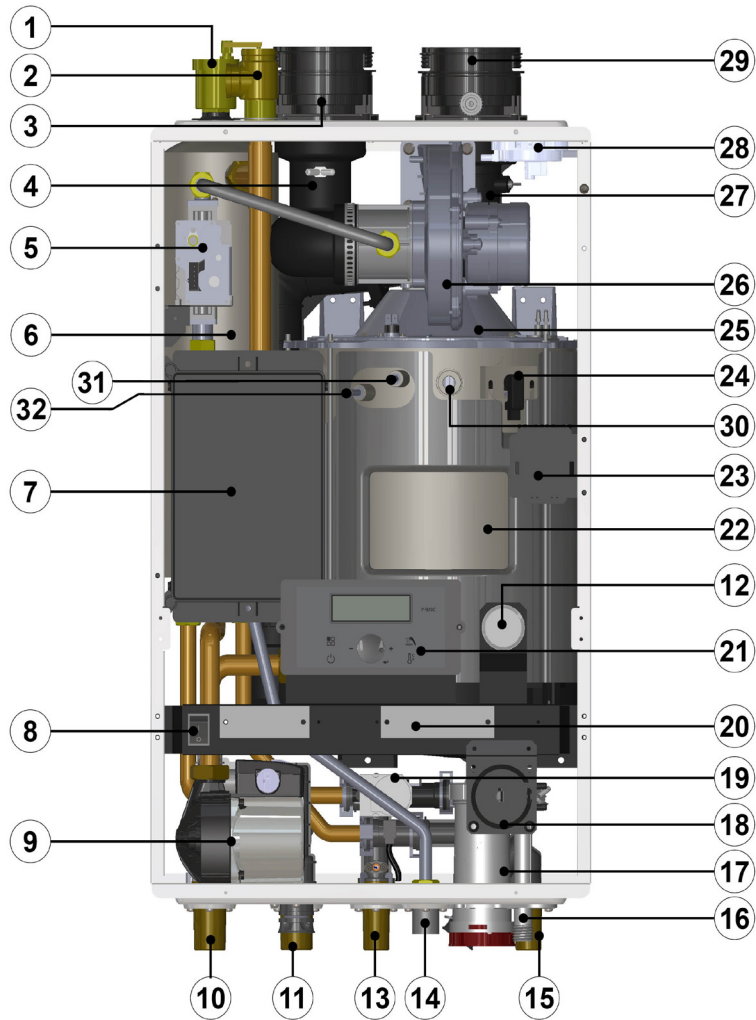

#	Name of Component
1	Air Vent (air eliminator)
2	Pressure Relief Valve
3	Air Intake Collar
4	Air Gas Mixing Pipe
5	Gas Valve
6	DHW Water Tank
7	Main PCB
8	Manual Power Switch (ON / OFF)
9	Boiler Pump
10	'CH' Supply Connection
11	'CH' Return Connection
12	CH Pressure Gauge
13	DHW Outlet Connection
14	Gas Inlet Connection
15	DHW Inlet Connection (filter and flow restrictor)
16	Condensate Connection

#	Name of Component
17	Condensate Trap
18	Blocked Condensate Switch
19	Mixing Valve
20	Terminal Block
21	Control Panel and Display
22	Heat Exchanger
23	Ignition Transformer
24	Flame Detecting Sensor
25	Burner Case
26	BLDC Fan (Blower)
27	Vent Pipe
28	Air Pressure Sensor
29	Vent Pipe Collar
30	Sight Glass
31	Low Water Cut Off
32	Overheat Temperature Sensor

3. Shut Down and Restart

3.1 To Start the FT Series Combi

If drained, please refer to the Install and Operating Manual to ensure that the complete 'Setup' procedure has been followed before starting this boiler. A complete 'Setup' must be performed by a qualified service person.

3.2 Shutting Down the FT Series Combi



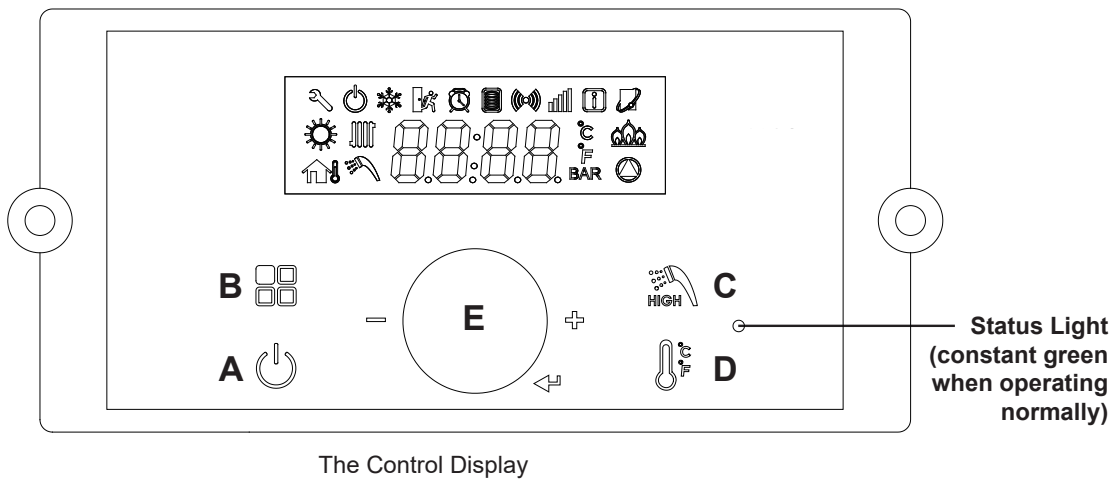

1. Turn off the main electrical disconnect switch.
2. Close all manual gas valves.
3. If freezing is anticipated, drain the FT Series Combi and be sure to also protect building piping from freezing. All water must be removed from heat exchanger and condensate trap or else damage from freezing may occur. Please refer to the Install and Operating Manual.

This step to be performed by a qualified service person.

4. The Control Display and Operation



The Control Display has a Control Dial (E), 4 buttons (A, B, C, D), and a Liquid Crystal Display (with 72 back-lit segments). This section of this manual gives instruction on how to navigate into the many functions of the FT and to change temperature set points, set system variables and controller parameters.

Buttons	Function	Method	Function	Method
A 	Display Power	Turns Control Display ON/OFF		Press/Tap
B 	Modes	Status Display Mode (With display power on)	Return to Menu (from Status Display Mode)	Press/Hold (5 Seconds)
		Installer Mode (With display power off)	Return to off display off mode (from installer mode)	Press/Hold (5 Seconds)
C 	Hot Water	DHW Set point LOW Range 95 - 120°F (35 - 49°C)	DHW set point HIGH Range 121-140°F (49.5-60°C) (from DHW set point LOW RANGE)	Press/Tap (To return home, tap Scroll/Select)
D 	Central Heat	CH set point mode (boiler only)	Toggle (°C/°F) (from CH set point mode)	Press/Hold (5 Seconds)
E 	Scroll / Select	Turn to scroll (clockwise or counterclockwise), Tap to select		Press/Tap

- Temperature Specifications
 - Operating ambient Temperature Range : -10 to 60°C.
 - Operating Relative Humidity up to: 90% at 40°C.
 - Shipping & Storage Temperature Range of : -20 to 80°C.

4. The Control Display and Operation (continued)

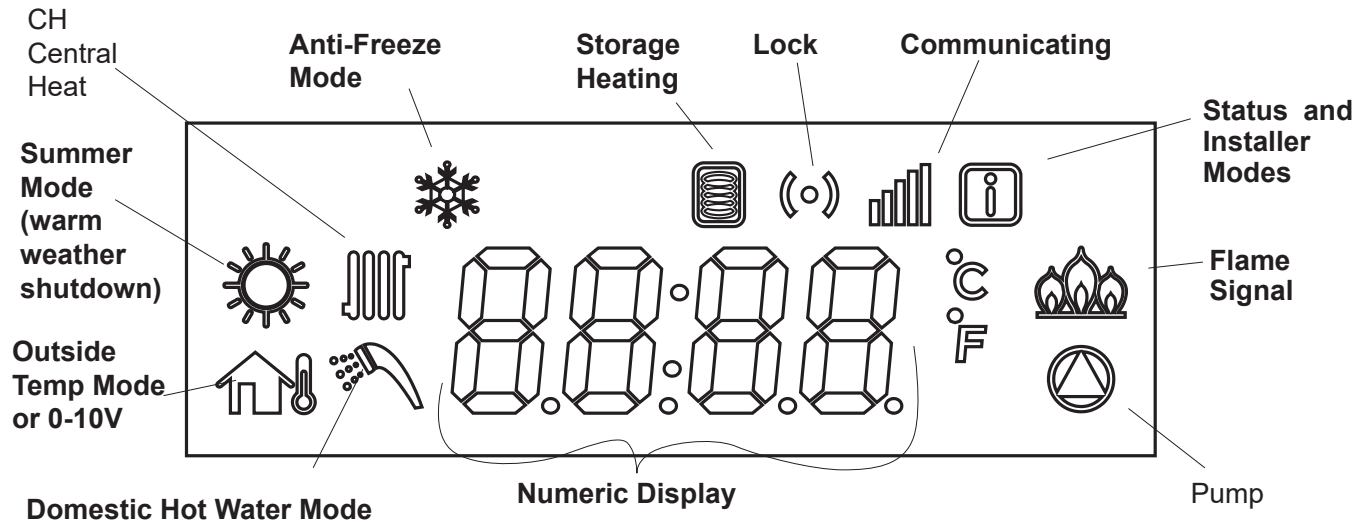

CH mode	Central Heat mode icon can be adjusted
Anti-freeze mode	Anti-freeze mode icon
Storage Heating mode	Stored Water Being Heated, can be adjusted
Lock mode	Buttons-locked mode icon
Communication	Communication icon
Summer mode	Only DHW Mode, can be adjusted (warm weather shutdown)
Status and Installer mode	The Status Mode or the Installer Mode is Active (all parameters)
Flame signal	Flame Signal icon
Pump icon	Water pump operation (CH or DHW) icon
Numeric Display	Number and character display, to display all parameters
DHW mode	Combination boiler Set Point, can be adjusted
Outside temp or 0-10 V mode	Operating by outside temperature or 0-10V

The LCD will illuminate when a user action is detected (a button is pressed) and will turn back off after 20 seconds.

* NOTE: The display will not allow changes when the lock mode (Ⓛ) is activated.
To exit the Lock mode, press the  button.

⚠ WARNING





Do not use this appliance if any part has been under water. Immediately call a qualified service technician to inspect the appliance and to replace any part of the control system and any gas control that may have been under water.

Operating Mode

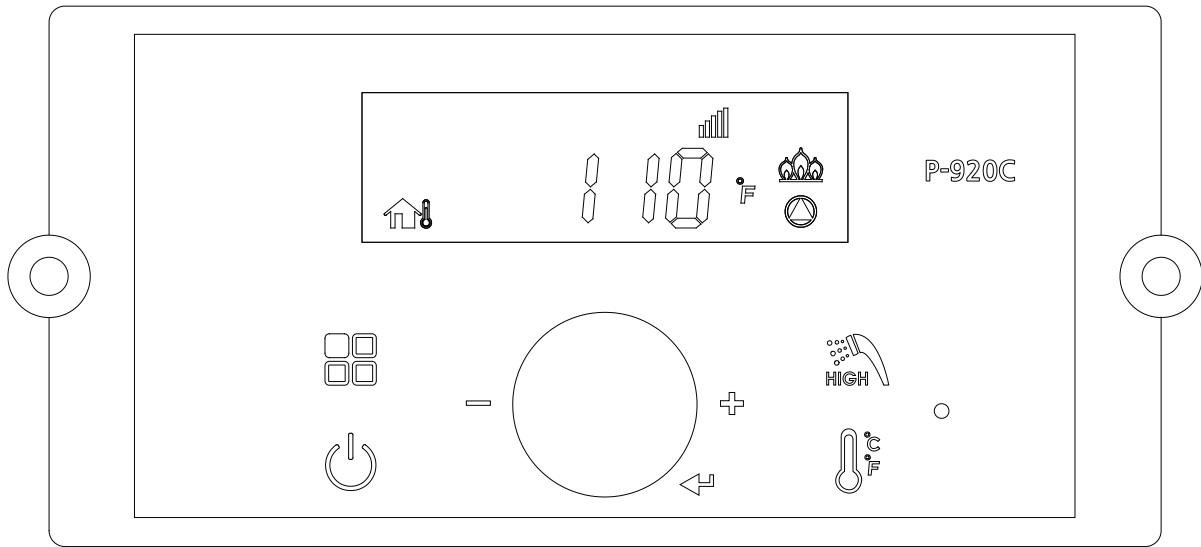
■ Operating Mode

After the Power is turned on, and/or the Control Display is turned on , the Control Display will go through a 'Start Up' checklist and briefly show a sequence of diagnostic codes before entering into the 'Operating Mode'. It will then display the following information.



Indicate	Example
Current Operating Temperature	110°F
Temperature sign Celsius or Fahrenheit letter	°C or °F
Display and Controller are communicating	
If flame detected	
If pump is operating	
Outdoor sensor or 0-10V	

Status Display Mode

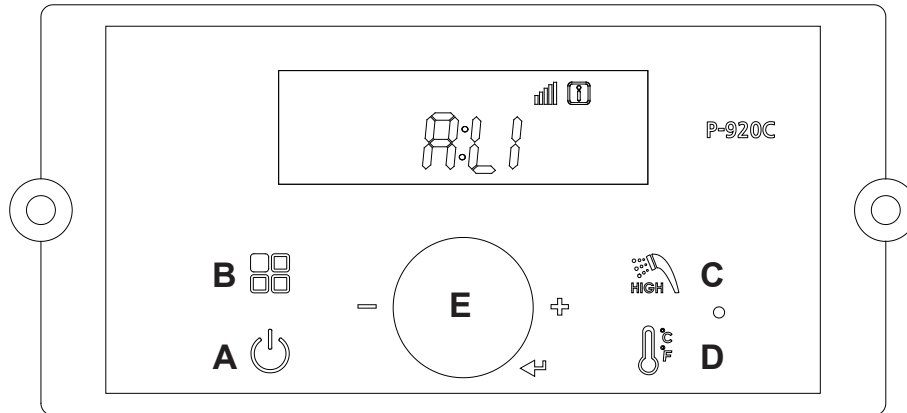

Digital Display	Status Display Parameter	Description		
O:ot	Outdoor temperature	Current Outdoor temperature		
A: Li or A: GA	Flow unit	Current flow value(Li: L/m, GA: GPM)		
b: It	CH Return Water Temperature	Current Return Water Sensor Temperature		
C: Fr	Fan rpm	Current fan rpm value		
d: Lc	Lock mode	Lock mode ON/OFF		
E: oP	OP temperature	Current OP temperature		
F: dH	DHW temperature	Current DHW temperature		
H: Eh	Exhaust temperature	Current Exhaust temperature		
I : St	N/A	Not Used (Default is 0)		
J: oH	Overheat temperature	Current Overheat temperature		
L: rt	1: PH	Supply power time	Supply power time x 100 hour	
	2: rh	Burner operation time	Burner operation time x 1 hour	
	3: rH	Burner operation time	Burner operation time x 1,000 hour	
	4: It	Ignition cycles	Ignition cycles x 10 times	
	5: IH	Ignition cycles	Ignition cycles x 10,000 times	
P: Ou	Displays output condition for internal primary pump and three way valve. - Off - On	1st Icon	2nd Icon	3rd Icon
		Not Used	Internal Pump	CH 3 Way Valve

To view any of the above listed Status Parameters,

Press and Hold Button B to get into the Status Display Mode.

Rotate Dial E until you find the Parameter that you wish to view. Tap Dial E to enter that Parameter.

Adjust to the setting that you require and then press (tap) Dial E to save and to Exit.

DHW Set Point Change Mode



■DHW Set Point Change Modes

The display shows the following information when changing water heating temperature set points.

Changing between Celsius and Fahrenheit

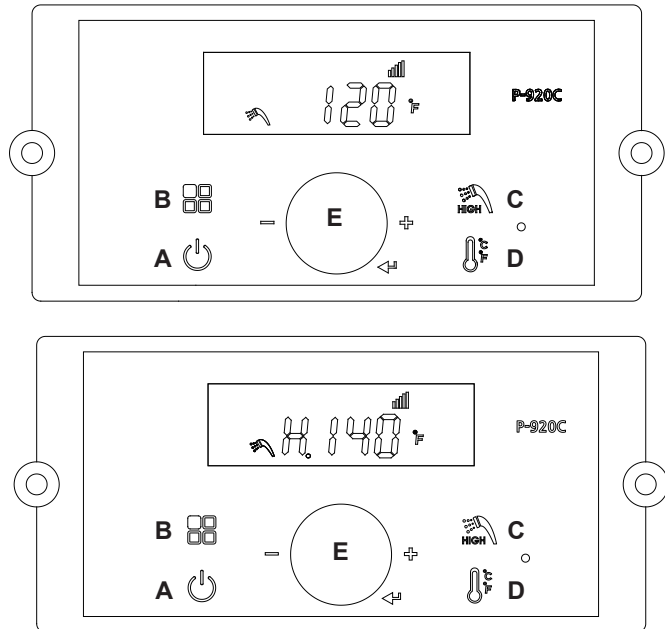
When the button D  is pressed (for more than 5 seconds), temperature unit will toggle between °C and °F.



Indicate	Example
Current DHW set point temperature	120°F
Temperature sign Celsius or Fahrenheit letter	°C or °F
If display is communicating with the main controller normally, the communication icon will be indicated.	
When DHW set point range is high : from 121°F (49.5°C) to 140°F (60.0°C)	H . 140°F
When changing DHW set point, the DHW icon will flash	

* Default DHW set point is 120°F (49°C)

• DHW 95-120°F (35 - 49°C) LOW range (Default)

-To change **LOW range**, press the C Button. The DHW icon and current DHW LOW will flash (a flashing value means it can be changed).

-Turn dial E clockwise to increase and counterclockwise to decrease until desired temperature is reached.

-Press dial E to save set point changes.

• DHW 121 - 140°F (49.5 - 60°C) HIGH range

-To change **HIGH range**, press and **HOLD** the C button for more than 5 seconds. The DHW icon and current DHW HIGH will flash (a flashing value means it can be changed).

-Turn dial E clockwise to increase and counterclockwise to decrease until desired temperature is reached.

-Press dial E to save set point changes and to Exit.



Scalding may occur within 5 seconds at a setting of 140°F (60°C). Water temperatures over 125°F can cause severe burns, or death from scalding. Children, disabled, and elderly are at highest risk of being scalded. Read all instructions before setting temperature at appliance. Feel water before bathing or showering.

Manufacturer strongly recommends the use of an anti-scald mixing valve at domestic hot water outlet (boiler location) to reduce potential for scalding. Contact Manufacturer for recommended models. Check with local codes.

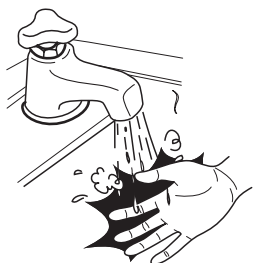



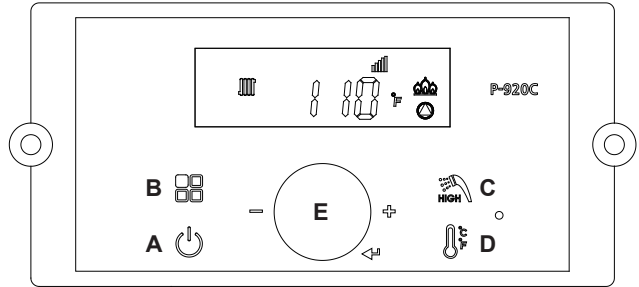

CH Set Point Change Mode

Changing between Celsius and Fahrenheit

When the button D  is pressed (for more than 5 seconds), temperature unit will toggle between °C and °F.



Indicate	Example
Current Operating Temperature	110°F
Temperature sign Celsius or Fahrenheit letter	°C or °F
Display and Controller are communicating	
If flame detected	
If pump is operating	
When changing CH Set point, the CH Icon will flash	

Default CH set point is 130°F (54°C)
 CH set point range is 130 - 180°F (54.4 ~ 82.0°C)





To change CH Set point, press the D  button. The CH Icon and current CH Set point will flash.

Turn the E dial clockwise to increase, and counterclockwise to decrease CH set point, until desired temperature is reached.

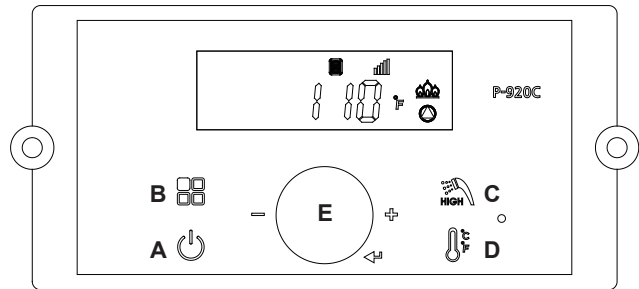
Press E dial to save changes and to Exit.

Storage Mode



Indicate	Example
Current Operating Temperature	110°F
Temperature sign Celsius or Fahrenheit letter	°C or °F
Display and Controller are communicating	
If flame detected	
Storage mode indication	
If Pump is operating	

To activate heat storage function, First turn OFF the power to the Control Display.

Then Press and Hold Button B  to get into the Installer Mode.

Rotate Dial E until you find **5:St** Tap Dial E to enter Storage Mode. Storage Mode indicates that the boiler is maintaining the water temperature in the internal storage tank. When Storage Mode is active, the display will appear as shown.

Turn the E dial clockwise to activate and counterclockwise to deactivate the Heat storage function. Default: ON. Press E dial to save changes and to Exit.

User's Manual - The FT Series Wall Mounted, Combination Boiler

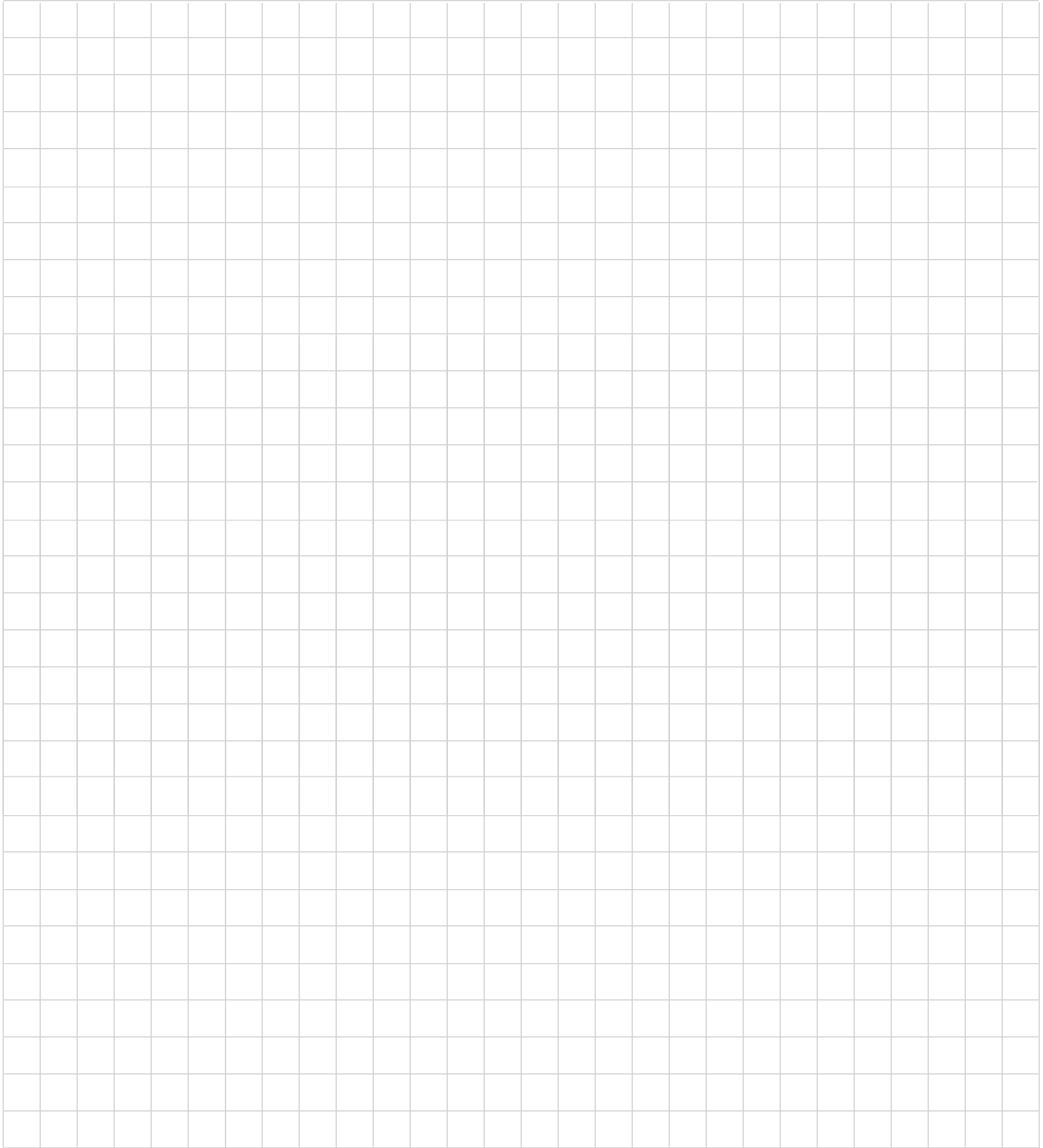

Dimensions and specifications subject to change without notice in accordance with our policy of continuous product improvement.

H2412500-



Customer Service and Product Support: 800.900.9276 • Fax 800.559.1583
20 Industrial Way, Rochester, NH, USA 03867