



User's Manual for  
**THE FT SERIES**

Wall-Mounted, Modulating  
Gas, Condensing, Heating Only, Boiler

Model FTHW 100,000 BTU/hr  
140,000 BTU/hr  
199,000 BTU/hr



- Natural Gas (NG) - Factory Configuration
- Propane Gas (LP) - Field-Convertible

**FOR YOUR SAFETY:** This product must be installed and serviced by a professional service technician, qualified in hot water boiler and heater installation and maintenance. Improper installation and/or operation could create carbon monoxide gas in flue gases which could cause serious injury, property damage, or death. Improper installation and/or operation will void the warranty.

**⚠ WARNING**

If the information in this manual is not followed exactly, a fire or explosion may result causing property damage, personal injury or loss of life.

Do not store or use gasoline or other flammable vapors and liquids in the vicinity of this or any other appliance.

**WHAT TO DO IF YOU SMELL GAS**

- Do not try to light any appliance.
- Do not touch any electrical switch; do not use any phone in your building.
- Immediately call your gas supplier from a nearby phone. Follow the gas supplier's instructions.
- If you cannot reach your gas supplier, call the fire department.

Installation and service must be performed by a qualified installer, service agency, or gas supplier.

**⚠ AVERTISSEMENT**

Assurez-vous de bien suivre les instructions données dans cette notice pour réduire au minimum le risque d'incendie ou d'explosion ou pour éviter tout dommage matériel, toute blessure ou la mort.

Ne pas entreposer ni utiliser d'essence ni d'autres vapeurs ou liquides inflammables dans le voisinage de cet appareil ou de tout autre appareil.

**QUE FAIRE SI VOUS SENTEZ UNE ODEUR DE GAZ:**

- Ne pas tenter d'allumer d'appareils.
- Ne touchez à aucun interrupteur. Ne pas vous servir des téléphones dans le bâtiment où vous êtes.
- Appelez immédiatement votre fournisseur de gaz depuis un voisin. Suivez les instructions du fournisseur.
- Si vous ne pouvez rejoindre le fournisseur de gaz, appelez le service des incendies.

L'installation et l'entretien doivent être assurés par un installateur ou un service d'entretien qualifié ou par le fournisseur de gaz.

CONTENTS

Pgs

1. Familiarizing yourself to the wall mounted FT Series Boiler .....2-3  
 2. Caring For Your FT Series Boiler.....4  
 3. Start Up and Shut Down. ....4  
 4. Control Setup and Operation.....5-10

1. Familiarizing yourself to

**THE FT SERIES**  
Boiler

The FT Series boiler is a highly efficient, wall mounted, condensing and fully modulating, residential boiler. This Users Manual will guide you into the basics of operating your FT Series Boiler.

Please reference the Installation and Operation Manual for complete details. Doc # 1483

MODEL NUMBER

4 SCREWS

CONTROL PANEL AND DISPLAY

CENTRAL HEAT PRESSURE GAUGE

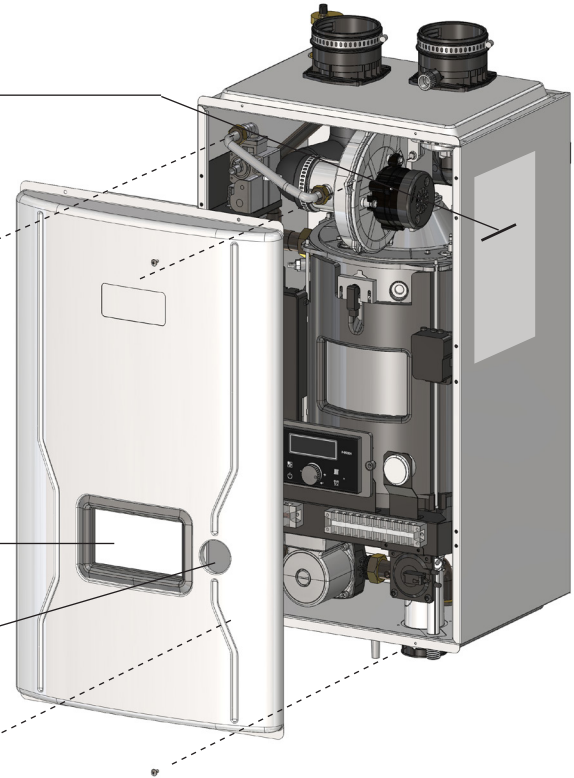

NO	Name of Component
1	Air Vent (air eliminator)
2	Air Intake Collar
3	Air / Gas Mixing Pipe
4	Gas Inlet Pipe 2
5	Gas Valve
6	Exhaust Duct
7	Low Water Cut Off
8	Overheat Temperature Sensor
9	Flame Detecting Sensor
10	Main PCB
11	Control Display
12	Manual ON/OFF Power Switch
13	Gas Inlet Pipe 1
14	'CH' Internal Pump
15	Gas Inlet Adapter
16	'CH' Supply Adapter

NO	Name of Component
17	CH Pressure Gauge
18	'CH' Return Adapter
19	Condensate Trap
20	Condensate Adapter
21	CH Return Temperature Sensor
22	Condensate Air Pressure Switch
23	Terminal Block
24	Heat Exchanger
25	Ignition Transformer
26	Sight Glass
27	Burner Overheat Switch
28	Igniter
29	BLDC Fan (blower)
30	Exhaust Temperature Sensor
31	Air Pressure Sensor
32	Vent Pipe Collar

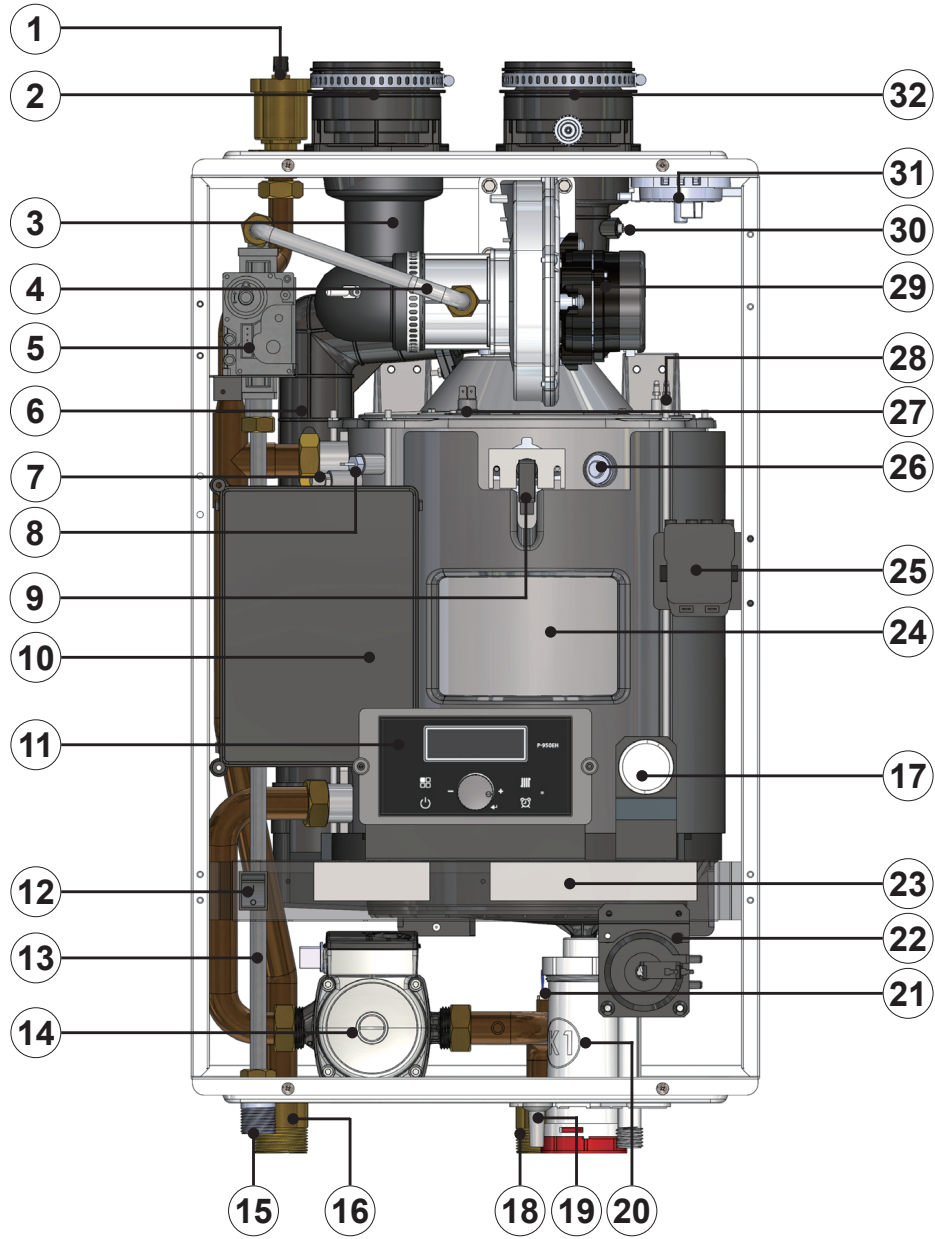

Shown is the FT Series Heating Only 140 MBH.  
All sizes are very similar in component layout.

## 2. Caring For Your FT Series Boiler

Your FT Series boiler will require very little maintenance. However, as with any fine appliance there are certain steps that should be taken to ensure continuing optimum performance.

### 2.1 General Care

Keep the area around the FT Series boiler clean and free from combustible materials, gasoline and other flammable liquids and vapors.

The FT Series Boiler must be completely isolated and protected from any source of corrosive chemical fumes such as trichlorethylene, perchlorethylene, chlorine, etc.

Keep bottom and top openings on the boiler free for proper ventilation of interior components.

Do not obstruct or block a free flow of air to the boiler to ensure proper ventilation.

If desired, clean the jacket surfaces with a damp cloth and mild detergent. Do not use flammable cleaning materials.

If sidewall vented, keep the vent terminal clear of obstructions — do not allow snow to cover the vent terminal. Clean the intake screen often, and then develop an appropriate maintenance schedule.

### 2.2 Annual Inspection of Flue and Vents

Visually inspect the vent pipe once a year. Should any deterioration exist, have the affected parts replaced by a qualified service person.

### 2.3 In the Event of a Power Failure

The FT Series boiler can not be operated during an electrical power outage. If there is an extended power outage with danger from freezing, then the FT Series Boiler (and all other water systems) should be drained completely. When draining the boiler, turn off main electrical disconnect switch. When placing back in service, refer to Section 3 of this Manual for instruction. All draining and filling must only be done by a qualified service person.

### 2.4 Full Service Every Year

In addition to the annual visual inspections, a qualified service agency should conduct a detailed inspection of all flue product carrying areas of the boiler and its venting system.

## 3. Shut Down and Restart

### 3.1 To Start the FT Series boiler

If drained, please refer to the Install and Operating Manual to ensure that the complete 'Setup' procedure has been followed before starting this boiler. A complete 'Setup' must be performed by a qualified service person.

### 3.2 Shutting Down the FT Series boiler

1. Turn off the main electrical disconnect switch.
2. Close all manual gas valves.
3. If freezing is anticipated, drain the FT Series Boiler and be sure to also protect building piping from freezing. All water must be removed from heat exchanger and condensate trap or else damage from freezing may occur. Please refer to the Install and Operating Manual, Doc # 1483 This step to be performed by a qualified service person.

## 4. The Control Display and Operation

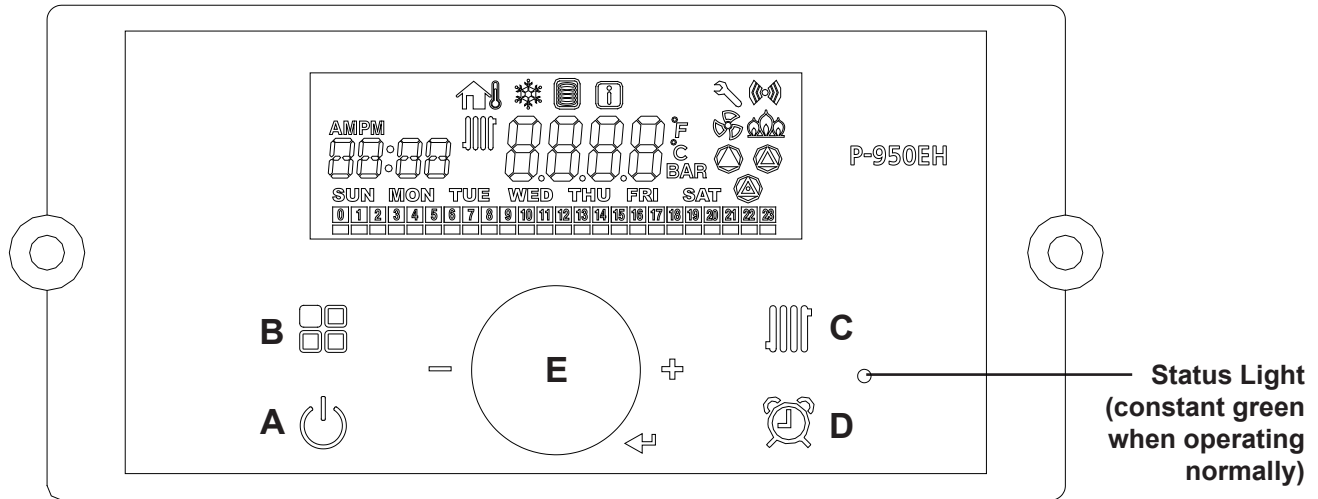

The Control Display

The **Control Display** has a Control Dial (E), 4 buttons (A, B, C, D), and a Liquid Crystal Display (with 72 back-lit segments). This section of this manual gives instruction on how to navigate into the many functions of the FT and to change temperature set points, set system variables and controller parameters.

Buttons			Functionality	
			PRESS (Tap)	PRESS and HOLD (5 seconds)
A		Display Power	Turns Control Display <b>ON/OFF</b>	
B		Modes	Tap to return to menu	(If Display Power was On ) <b>Status Display Mode</b> (If Display Power was Off ) <b>Installer Mode</b>
C		Heating Water	CH set point change mode (Maximum 82°C(180°F))	
D		Time / Date Set	No Change	To SET: Year/Month/Week/Day/Time/Min
E		Scroll / Select	Menu select or value up(+)/down(-) or setting dial.	

- Temperature Specifications
  - Operating ambient Temperature Range : -10 to 60°C.
  - Operating Relative Humidity up to: 90% at 40°C.
  - Shipping & Storage Temperature Range of : -20 to 80°C.

### WARNING

Do not use this appliance if any part has been under water. Immediately call a qualified service technician to inspect the appliance and to replace any part of the control system and any gas control that may have been under water.

## 4. The Control Display and Operation (continued)

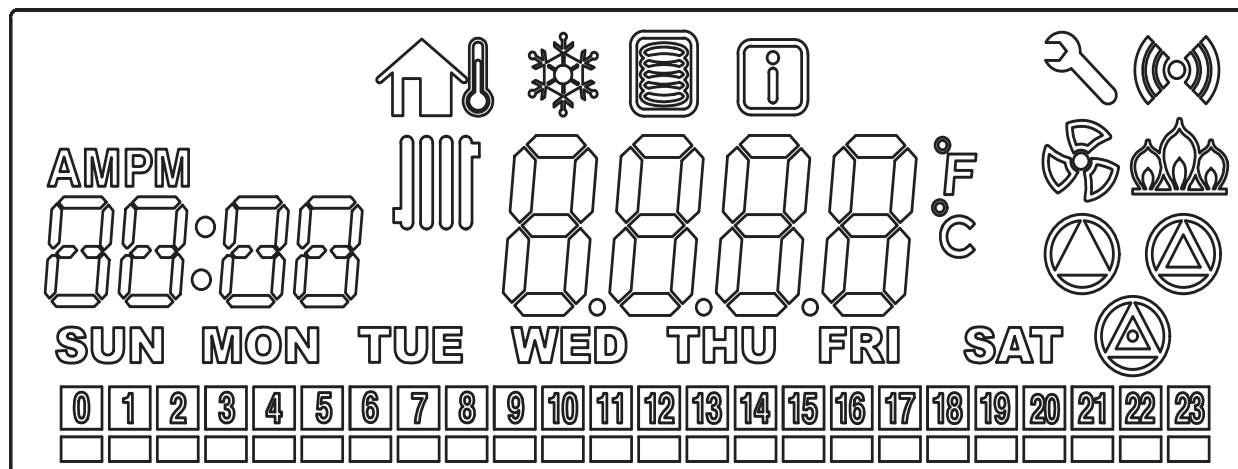

Symbol	Name	Description
	Service Reminder mode	Service Reminder mode indication
	Outside Temperature Mode	Outside Temp setting indication
	Anti-freeze mode	Anti-freeze mode indication
	Storage mode	Storage mode indication
	Information mode	Information mode indication
	Communication state	Communication state indication
	Time setting mode	Time /Dispaly/Install mode indication
	Fan operating mode	Fan operating mode indication
	Flame signal	Flame Signal indication
	CH pump mode	CH pump mode indication
	Storage pump mode	Storage pump mode indication
	Internal boiler pump	Internal Boiler pump mode indication
	Celsius mode	Indicated as Celsius temperature
	Fahrenheit mode	Indicated as Fahrenheit temperature
	Heat demand mode	Heat demand mode indication
	DAY mode	Current day mode indication
	Cascade System connecting mode	Cascade System connecting mode indication
	Cascade System operating mode	Cascade System operating mode indication







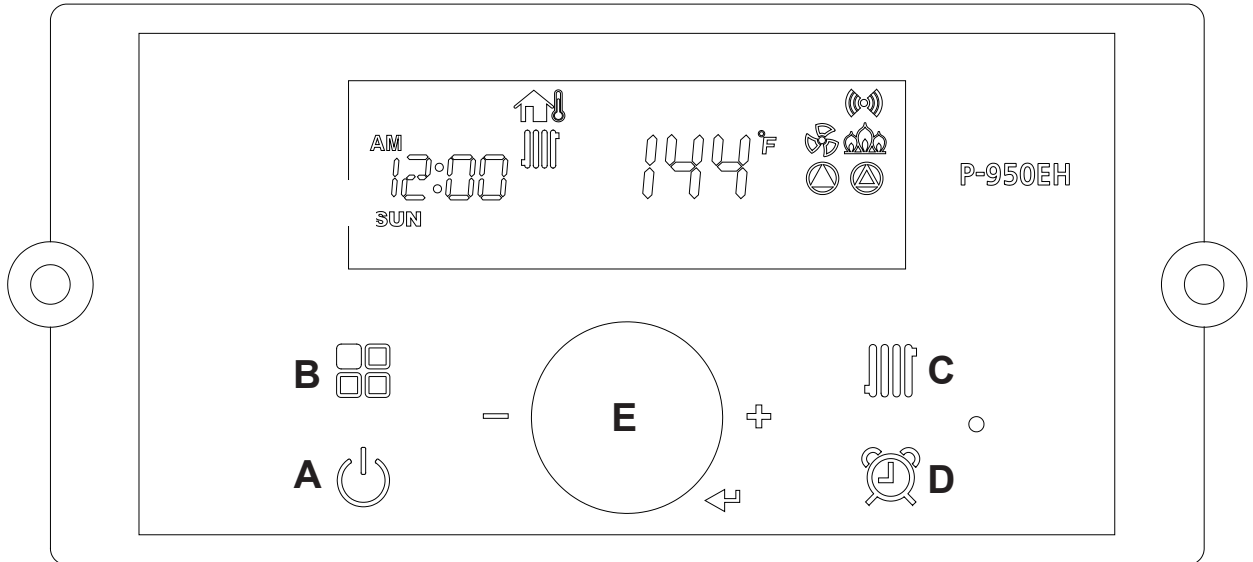

The LCD will illuminate when a user action is detected (a button is pressed) and will turn back off after 20 seconds.

## Operating Mode

### ■ Operating Mode

After the Power is turned on, and/or the Control Display is turned on , the Control Display will go through a 'Start Up' checklist and briefly show a sequence of diagnostic codes before entering into the 'Operating Mode'. It will then display the following information.



Indicate	Indicator
Current Operating Temperature Set point	
If the Fan is operating	
If a flame is detected	
Celsius or Fahrenheit	°C or °F
Date and Time indicator	AM PM 00:00
If Outside Temperature Sensor is operating	
If there is a Demand for Central Heat (CH)	
If CH pump state is operating	
If Internal recirculation pump is operating	
If Communication state is activated	

The Control Display can operate through user and service modes that have specific LCD output and dedicated controls:

- Set point change mode • Lock mode • Error mode • Status display mode
- Outside Temperature mode • Installer mode

\* Control Display will not allow changing of button in case of lock mode activated.

## Setting the Clock

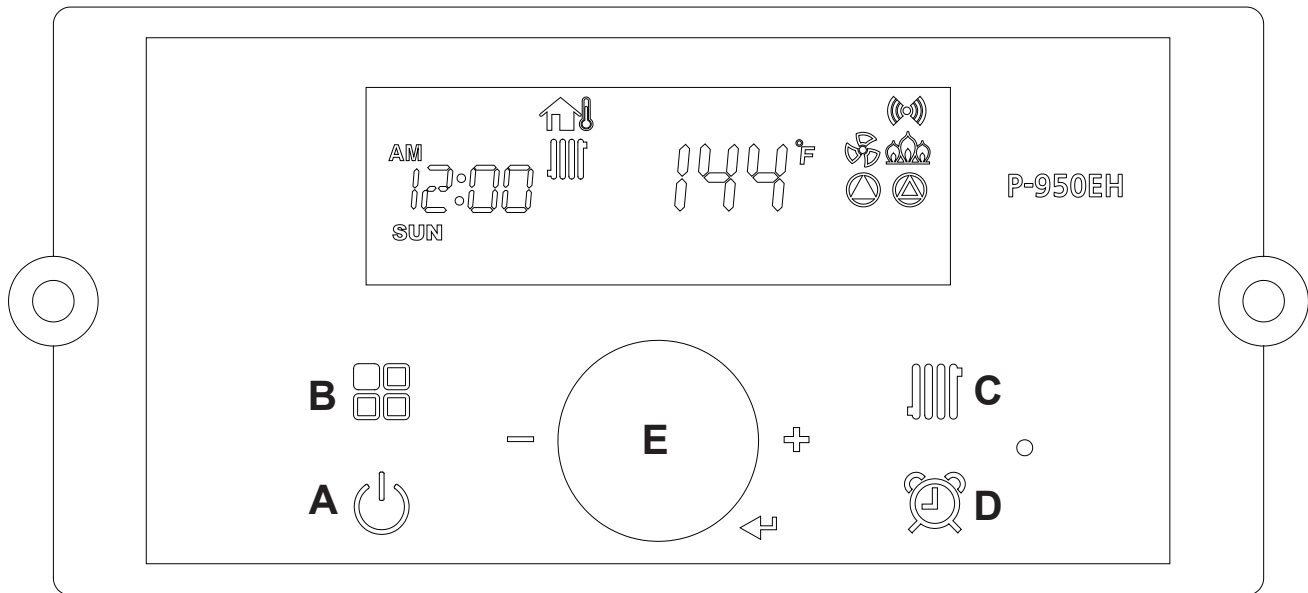

The P-950EH Control Display does NOT have a daily timer or programmable thermostat.

### Setting the Clock

- Press and hold the  'Clock button' for about 5 seconds. Set the 'Year' by turning the dial **E**. And then, press the dial **E** to Save.
- Set the '**MON**' (Month) by turning the dial **E** to the desired month number. Then press the dial **E** to Save.
- Set the '**DATE**' (1-31, Day of the Month) by turning the dial **E**. Then press the dial **E** to Save.
- Set the '**HOUR**' (1-24, Hour of the Day) by turning the dial **E**. Then press the dial **E** to Save.
- Set the '**MIN**' (1-60, Minute of the Hour) by turning the dial **E**. Then press the dial **E** to Save.
- Set the '**Day**' (Sun - Sat) by turning the dial **E**. Then press the dial **E** to Save.

To Exit at any time, tap the  button.



### CH Set Point Change Mode



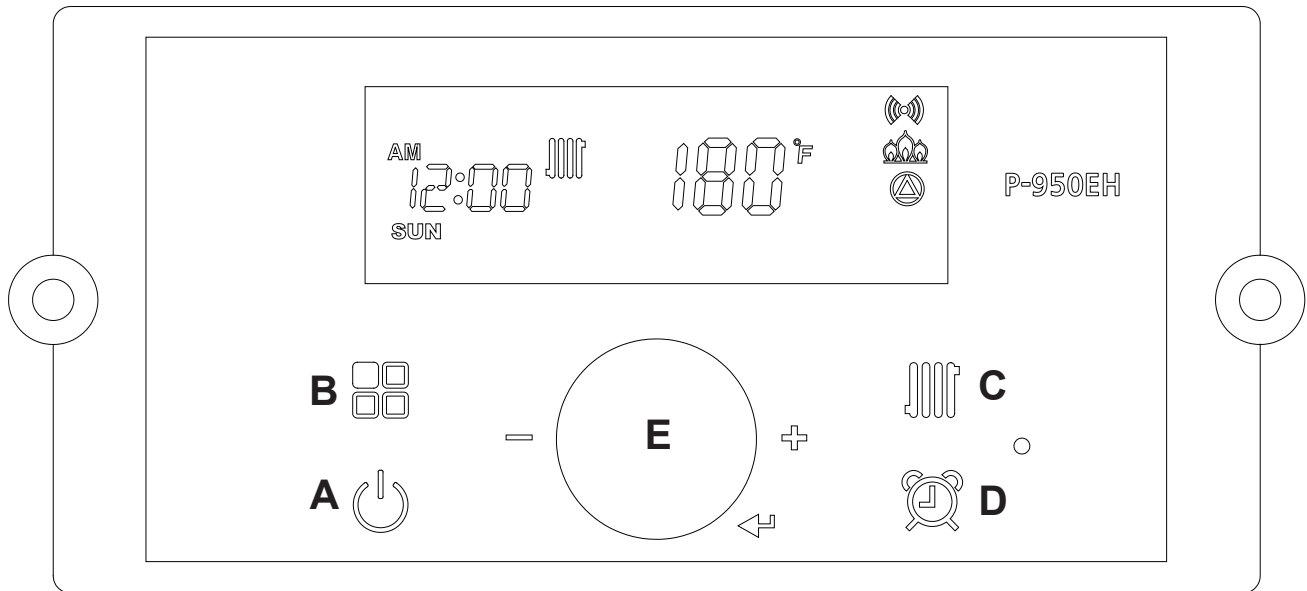

- CH Set point Change Mode

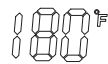

**To change CH Set point,** press the C  button. The CH Icon and current CH Set point will flash.

Turn the E dial clockwise to increase, and counterclockwise to decrease CH set point, until desired temperature is reached.

Press E dial to save changes and to Exit.

Indicate	Indicator
Current CH Temperature Set point	
Celsius or Fahrenheit	°C or °F
If Communication state is activated	
If flame is detected	
Date and Time indicator	AM PM 00:00
If CH pump is operating	
If there currently a Demand for Central Heat (CH)	

Default CH set point is 180°F (82°C)

CH set point range is 130°F ~180°F (54°C ~ 82.0°C)

## Status Display Mode

### To view any Status Parameter,

Press and Hold Button B  to get into the Status Display Mode.

Rotate Dial E until you find the Parameter that you wish to view. Tap Dial E to enter that Parameter as required. Dial E to save and to exit the Status Information Menu. To go back to the Operation Screen Press button B.

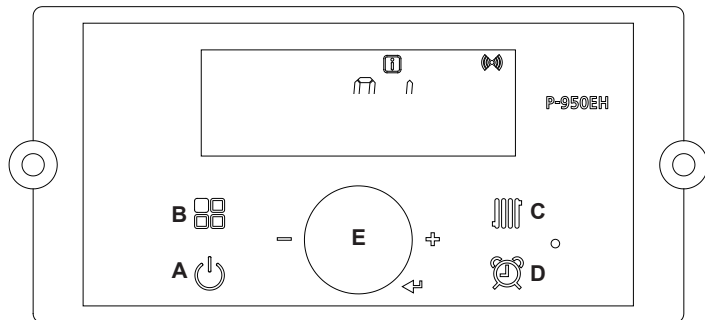

**NOTE:** For Cascading Installations, please refer to document 1349 'Cascading the FT Series Boiler', available online.

Digital Display	Status Display Parameter	Description	
<b>O: ot</b>	Outdoor temperature	Current outdoor sensor temperature	
<b>A: In</b>	0-10 V display	Current voltage of (0-10V input)	
<b>b: tt</b>	CH target temperature in cascade system	Current CH target temperature or Current System target temperature in a cascade system	
<b>C: It</b>	CH return water temperature	Current CH return water temperature	
<b>d: Fr</b>	FAN speed ( rpm)	Current FAN speed ( RPM)	
<b>E: oP</b>	CH supply temperature (Operating temperature)	Current heating temperature	
<b>F: Eh</b>	Exhaust gas temperature	Current exhaust gas temperature	
<b>H: dH</b>	Indirect DHW tank temperature * If temperature sensor is not connected then it will display with 0°F (0°C).	Current DHW tank temperature	
<b>I: oH</b>	Overheat water temperature	Current Overheat water temperature	
<b>L: rt</b>	<b>1: PH</b>	Time for supply power	Unit : 1000hour
	<b>2: rh</b>	Time for burner operation	Unit : 1hour
	<b>3: rH</b>	Time for burner operation	Unit : 1,000hour
	<b>4: It</b>	Cycle for ignition	Cycle : 10 times the displayed unit
	<b>5: IH</b>	Cycle for ignition	Cycle : 10,000 times the displayed unit
<b>M: CC</b>	<b>SELF</b>	Percentage of self units running.	Percentage of self units running.
	<b>ALL</b>	Capacity for all operating cascade units	Percentage of all cascade units running. This screen shows the overall cascade power output. The range of this value of boilers communicating with the Master x 100. For example, if 8 boilers are connected and communicating, the maximum cascade power is 800%. Range: 0-100%
	<b>F1 – F19</b>	Capacity for individual boilers	Percentage of each cascade units running. Ex. F1, F2, ....
<b>N: St</b>	System Temperature (cascade mode) * If system temperature sensor is not connected then it will display with 0°F (0°C).	Current System Temperature (cascade mode)	



