

SERVICE MANUAL

Troubleshooting Guide and Instructions for Service
(To be performed ONLY by qualified service providers)

Ultra High Efficiency Water Heater with ICON and Integrated Control Systems



Models Covered:

SECTION 1 (PG. 9): SERIAL NUMBERS “XC-” (MAR. 2021) AND LATER:

60T125(E)*(N,X)(A)(2); 60T150(E)*(N,X)(A)(2);
60T199(E)*(N,X)(A)(2); 100T150(E)*(N,X)(A)(2);
100T199(E)*(N,X)(A)(2); 100T250(E)*(N,X)(A)(2);
100T300(E)*(N,X)(A)(2)

SECTION 2 (PG. 53): SERIAL NUMBERS “XL-” (NOV. 2021) AND LATER W/ -895 DESIGNATOR:

60T125(E)*(N,X)(A)(2); 60T150(E)*(N,X)(A)(2);
60T199(E)*(N,X)(A)(2); 100T150(E)*(N,X)(A)(2);
100T199(E)*(N,X)(A)(2)

(*) Denotes warranty years



As required by the state of California Proposition 65.

— BRADFORD WHITE IS —

**AMERICAN
STRONG**[™]

Products made by Bradford White are
manufactured in the United States using
the finest raw materials and components
from around the world.

Table of Contents

	Page	Service Procedure
Serial Number Breakdown.....	4	---
Introduction.....	5	---
How to Use this Manual.....	5	---
Tools Required for Service.....	6	---
Venting Tables and Approved Venting.....	7	---
Specifications.....	9	---

Section 1: Serial Numbers “XC-” (March 2021) and Later

ICON System Features.....	10	---
Sequence of Operation.....	11	---
Building Management System (BMS).....	13	---
Troubleshooting.....	15	---
Thermostat Circuit Testing and Replacement.....	26	I
Combustion System Testing and Replacement.....	31	II
Burner Tube Inspection and Replacement.....	35	III
Gas Valve Replacement.....	37	IV
Blower Testing and Replacement.....	38	V
Exhaust Pressure Switch Testing and Replacement.....	40	VI
Flame Sensor Testing and Replacement.....	44	VII
Spark Rod Gap Adjustment and Replacement.....	45	VIII
Ignition Module/Control Board Replacement.....	47	IX
Transformer Replacement.....	48	X
Vent Safety Switch Testing and Replacement.....	49	XI
Flue Baffle Inspection and Replacement.....	51	XII
Procedure for Access to Magnesium Anodes & Flue Baffles	52	XIII
Magnesium Anode Inspection and Replacement.....	53	XIV
Powered Anode Replacement.....	54	XV

Table of Contents

Section 2: Serial Numbers “XL-” (Nov. 2021) and Later with -895 Designator

	Page	Service Procedure
Specifications.....	55	---
Features.....	56	---
Sequence of Operation.....	57	---
Troubleshooting.....	58	---
Thermostat Circuit Testing and Replacement.....	72	I
Combustion System Testing and Replacement.....	76	II
Burner Tube Inspection and Replacement.....	80	III
Gas Valve Replacement.....	82	IV
Blower Testing and Replacement.....	83	V
Exhaust Pressure Switch Testing and Replacement.....	85	VI
Flame Sensor Testing and Replacement.....	88	VII
Spark Rod Gap Adjustment and Replacement.....	90	VIII
Ignition Module/Control Board Replacement.....	92	IX
Transformer Replacement.....	93	X
Vent Safety Switch Testing and Replacement	94	XI
Flue Baffle Inspection and Replacement.....	96	XII
Powered Anode Replacement	97	XIII
Installation Checklist.....	98	---
Notes.....	98	---

Determining the Age of Your Water Heater

SERIAL NUMBER SECTION: The first two characters represent the year and month of manufacture. The remainder of the serial is a sequential production number, seven digits in length before December 2007 (DM), and eight digits in length after.

Example:

J C 16433183

J = Built in
the year 2012

C = Built in the
month of March

The remainder of the serial
is just a sequential number

Production Year	
A = 1984 or 2004	L = 1994 or 2014
B = 1985 or 2005	M = 1995 or 2015
C = 1986 or 2006	N = 1996 or 2016
D = 1987 or 2007	P = 1997 or 2017
E = 1988 or 2008	S = 1998 or 2018
F = 1989 or 2009	T = 1999 or 2019
G = 1990 or 2010	W = 2000 or 2020
H = 1991 or 2011	X = 2001 or 2021
J = 1992 or 2012	Y = 2002 or 2022
K = 1993 or 2013	Z = 2003 or 2023

Production Month	
A = January	G = July
B = February	H = August
C = March	J = September
D = April	K = October
E = May	L = November
F = June	M = December

For the year column, we do not use the letters: I, O, Q, R, U, V

For the month column we do not use the letters: I & N - Z

Due to a computer error, there were some OA serial water heaters manufactured. They were built in January of 1997.

Determining the Designator of Your Water Heater

DESIGNATOR SECTION: See special product type designator in this location on the rating plate. If "D/N:" line is blank, then there is no designator.

Example in red box:

BRADFORD WHITE CORPORATION www.bradfordwhite.com 11
200 LAFAYETTE STREET MIDDLEVILLE MI 49333 USA
Model No: EF100T199E3N2
Serial No: XK48743746 **D/N: -895**
Capacity : 100 US gal Recovery: 238.8 gph
378.5 liters Type: NATURAL GAS
Input: 199999(Btu/hr)
Gas Pressure Manifold : -0.05(InWC)
120V 60 Hz Less than 12 amps
Alcove Installation, Combustible Floors:
Min Clearances from Combustible Construction
0" (Sides/Rear) 0" (Top) 0" (Vent Conn)
For use only with Automatic Flue Device Part
No. N/A FOLLOW INSTALLATION INSTRUCTIONS
AUTOMATIC STORAGE TANK / CIRCULATING TANK
CATEGORY IV
ANSI Z21.10.3-2017/CSA 4.3-2017
Pressure: Test 300 psi, Working 150 psi
COMPLIES W/JURISDICTIONS HAVING 14ng/J NOx REGS

BRADFORD WHITE CORPORATION www.bradfordwhite.com 11
200 LAFAYETTE STREET MIDDLEVILLE MI 49333 USA
Model No: EF100T199E3N2
Serial No: XK48743746 **D/N:**
Capacity : 100 US gal Recovery: 238.8 gph
378.5 liters Type: NATURAL GAS
Input: 199999(Btu/hr)
Gas Pressure Manifold : -0.05(InWC)
120V 60 Hz Less than 12 amps
Alcove Installation, Combustible Floors:
Min Clearances from Combustible Construction
0" (Sides/Rear) 0" (Top) 0" (Vent Conn)
For use only with Automatic Flue Device Part
No. N/A FOLLOW INSTALLATION INSTRUCTIONS
AUTOMATIC STORAGE TANK / CIRCULATING TANK
CATEGORY IV
ANSI Z21.10.3-2017/CSA 4.3-2017
Pressure: Test 300 psi, Working 150 psi
COMPLIES W/JURISDICTIONS HAVING 14ng/J NOx REGS

Introduction

The Ultra High Efficiency Water Heater is designed to deliver a high thermal efficiency rating in a quiet running unit with venting options that allow for installation flexibility. Several technologically advanced design features are incorporated in the design that will require additional knowledge on the part of the qualified service provider. The information in this manual will instruct service and maintenance professionals on the function, proper diagnosis and repair of The Ultra High Efficiency Water Heater.

The Ultra High Efficiency Water Heater uses a Low NOx premix power burner located at the top of the water heater to direct a turbulent flame down into a submerged combustion chamber. This turbulence causes a thorough mixing of gas and air for optimum combustion. The combustion gases then travel through a three-pass flue system keeping the gases moving at a high velocity. The combination of high turbulence and velocity results in an optimum transfer of heat from the flue gases into the water.

Burner operation is controlled using an electronic ignition module. The module monitors the status of the electronic thermostat, vent temperature limit switch, vent system pressure switches, a flame sensor to control output voltage to blower motor, igniter/spark rod, and gas valve. The module contains programming which determines the sequence of operation and timings for purge periods, trial for ignition, flame sensing, and lockout. The module will also provide diagnostic information to help in determining the cause of system lockouts.

The contents in this manual are detailed informational tools to assist in the proper diagnosis of the Ultra High Efficiency Water Heater operational faults. Please read this service manual completely and provide as much information regarding the Ultra High Efficiency Water Heater operation and installation specific concerns.

How to Use this Manual

It is intended for this manual to be used by qualified service personal for the primary purpose of troubleshooting analysis and repair of the Ultra High Efficiency Water Heater. Understanding the sequence of operation section of this manual will contribute greatly to troubleshooting this product.

An Installation Checklist is shown towards the end of this manual. Compare the installation against the installation check list to confirm all requirements are met.

A Service Report is shown towards the end of this manual. Completing this form will assist in the troubleshooting efforts. Should you need to call for technical support, please provide the information shown on this form to the support technician to insure accurate troubleshooting.

Troubleshooting begins with System Observation to determine failure mode as indicated by the LED status of the ignition module. Troubleshooting continues with Failure Modes and Probable Cause, directing the service provider to a series of test procedures to determine root cause of failure. Component replacement procedures directly follow the test procedures for a given component.

In some difficult to diagnose conditions, it may be necessary to isolate the heater from the vent system to determine root cause. Contact Technical Support immediately if diagnosis is not determined using the methods described in this Service Manual.

Tools Required for Service

- Manometer:** Two types available, a liquid "U" tube type or a digital (magna-helic) type. This device is used to measure gas and/or air pressures and vacuum.
- Multi-Meter:** A digital type is strongly recommended. This device is used to measure electrical values. The meter you select must have the capability to measure volts AC, volts DC, Amps, micro-amps and ohms.
- Thermometer:** Used to measure water temperature. An accurate thermometer is recommended.
- Water Pressure Gage:** Used to measure water supply pressure. Also used to determine tank pressure by adapting to the drain valve of the heater.
- Jumper Leads:** A length of wire (12" min.) with alligator clip at both ends.
- Various Hand Tools:** Pipe wrench, channel locks, open end wrench set, 12" crescent wrench, Allen wrench set, Torx bit set, screwdrivers (common & Phillips), long reach (12") magnetic tip Phillips head screwdriver #2 tip, 1/4" nut driver, pliers (common & needle nose), socket set including a 1-1/16 deep well socket, wire cutters, wire strippers, wire crimpers, torpedo level, small shop vac, step ladder, and flashlight.

Vent Tables

Maximum Vent Length

Table 3 - Maximum Vent Length (Combined Maximum Length for Intake and Exhaust)

	60T-125		60T-150 100T-150		60T-199 100T-199	
2" Vent Pipe	Power Direct Vent	Power Vent	Power Direct Vent	Power Vent	Power Direct Vent	Power Vent
Max. Intake Length	15 ft (4.5 m)	N/A	15 ft (4.5 m)	N/A	15 ft (4.5 m)	N/A
Max. Exhaust Length	15 ft (4.5 m)	30 ft (9.2 m)	15 ft (4.5 m)	30 ft (9.2 m)	15 ft (4.5 m)	30 ft (9.2 m)

	60T-125 100T-150		60T-150 100T-199		60T-199 100T-250		100T-300	
3" Vent Pipe	Power Direct Vent	Power Vent	Power Direct Vent	Power Vent	Power Direct Vent	Power Vent	Power Direct Vent	Power Vent
Max. Intake Length	60 ft (18.3 m)	N/A	50 ft (15.2 m)	N/A	40 ft (12.2 m)	N/A	30 ft (9.2 m)	N/A
Max. Exhaust Length	60 ft (18.3 m)	120 ft (36.5 m)	50 ft (15.2 m)	100 ft (30.5 m)	40 ft (12.2 m)	80 ft (24.3 m)	30 ft (9.2 m)	60 ft (18.3 m)

4" Vent Pipe	Power Direct Vent	Power Vent	Power Direct Vent	Power Vent	Power Direct Vent	Power Vent	Power Direct Vent	Power Vent
Max. Intake Length	85 ft (25.9 m)	N/A	75 ft (22.8 m)	N/A	65 (19.8 m)	N/A	55 (16.7 m)	N/A
Max. Exhaust Length	85 ft (25.9 m)	170 ft (51.8 m)	75 ft (22.8 m)	150 ft (45.7 m)	65 (19.8 m)	130 (39.6 m)	55 (16.7 m)	110 (33.5 m)

	60T-125		60T-150		60T-199		100T-150	
6" Vent Pipe	Power Direct Vent	Power Vent	Power Direct Vent	Power Vent	Power Direct Vent	Power Vent	Power Direct Vent	Power Vent
Max. Intake Length	85 (25.9 m)	N/A	75 (22.8 m)	N/A	65 (19.8 m)	N/A	85 (25.9 m)	N/A
Max. Exhaust Length	85 (25.9 m)	170 ft (51.8 m)	75 (22.8 m)	150 (45.7 m)	65 (19.8 m)	130 (39.6 m)	85 (25.9 m)	170 (51.8 m)

	100T-199		100T-250		100T-300	
6" Vent Pipe	Power Direct Vent	Power Vent	Power Direct Vent	Power Vent	Power Direct Vent	Power Vent
Max. Intake Length	75 (22.8 m)	N/A	65 (19.8 m)	N/A	60 (18.3 m)	N/A
Max. Exhaust Length	75 (22.8 m)	150 (45.7 m)	65 (19.8 m)	130 (39.6 m)	60 (18.3 m)	120 (36.6 m)

Unbalanced Direct Vent Systems
Air intake CAN NOT exceed exhaust by more than 30 feet.

WARNING!
The 100T250 and 100T300 models are **NOT** approved for 2 inch diameter vent pipe. Venting with 2 inch pipe on these models may result in damage to the water heater or cause an unsafe condition. **DO NOT** use 2 inch vent or air intake pipe on 100T250/300 models.

Notes:

- 1) Multiply the total number of 90° elbows (intake and exhaust) by 5 feet. **Do NOT** include the termination fittings or 3" condensate elbow.
- 2) Multiply the total number of 45° elbows (intake and exhaust) by 2 ½ feet.
- 3) Add this to the total length of straight pipe - intake and exhaust.
- 4) The sum total of all elbows and straight pipe - intake and exhaust must not exceed maximum lengths from tables above.

Venting Tables Cont.

Example: 100T199

A 3" balanced direct vent system has 30 feet of straight exhaust pipe and 30 feet of straight intake pipe. It has 3- 90° elbows in the exhaust and 3- 90° elbows in the intake. It has 1- 45° elbow in the exhaust and 1- 45° elbow in the intake.

Therefore:

6- 90° elbows x 5 feet = 30 feet.

2- 45° elbows x 2½ feet = 5 feet.

60 feet of straight pipe + 30 feet + 5 feet = 95 feet.

System is within "Maximum Combined Length" from table above.

NOTICE

For installations in Canada, field supplied vent piping must comply with CAN/CGA B149.1 (latest edition) and be certified to the Standard For Type BH, Class II, 65°C, Gas Venting Systems, ULC S636. Components of this listed system shall not be interchanged with other vent systems or unlisted pipe/fittings. All components and specified primers and cements of the certified vent system must be from a single system manufacturer and not intermixed with other system manufacturer's vent system parts. The supplied vent connector and vent termination are certified under ULC S636 and are also certified as part of the water heater. Refer to the following tables for approved venting materials, primers, and cements. All approved primers and cements are to be used within their marked time limitations.

Approved Venting Materials

For installations in the US only

- PVC DWV (ASTM D-2665)
- PVC Sch. 40 (ASTM-D1785)
- CPVC Sch. 40 (ASTM-F441, ASTM-D2846)
- PVC and CPVC (UL 1738, ULC S636)
- ABS Sch. 40 DWV (ASTM-D2661)
- Polypropylene (UL 1738, ULC S636)
- Stainless Steel (UL 1738, ULC S636)

For installations in CANADA

- ULC S636 approved PVC for flue gas venting rated Class II, 65°C
- ULC S636 approved CPVC for flue gas venting rated Class II, 65°C
- ULC S636 approved Polypropylene for flue gas venting rated Class II, 65°C
- Stainless Steel (ULC S636)

Approved Primers and Cements

For installations in the US only

- PVC and CPVC Primer (ASTM-F656)
- PVC Cement (ASTM D-2564)
- CPVC Cement (ASTM F493)
- ABS Primer and Cement (ASTM D-2235)

For installations in CANADA

- ULC S636 approved Primer and Cement for flue gas venting rated Class II, 65°C

NOTICE

Use of cellular core PVC (ASTM F891), cellular core CPVC, or Radel® (polyphenosulfone) in non-metallic venting systems is prohibited and covering non-metallic venting with thermal insulation is prohibited.

NOTICE

Before beginning installation of any vent pipe, read the vent pipe manufacturer's installation instructions.

DO NOT install the water heater in any location where the ambient temperature may fall below freezing. Water heater **must** be protected from freezing downdrafts during shutdown periods.

Provide protection of the building materials from degradation by flue gases from the exhaust vent terminal.

Section 1: Serial Numbers "XC-" (March 2021) and Later Specifications

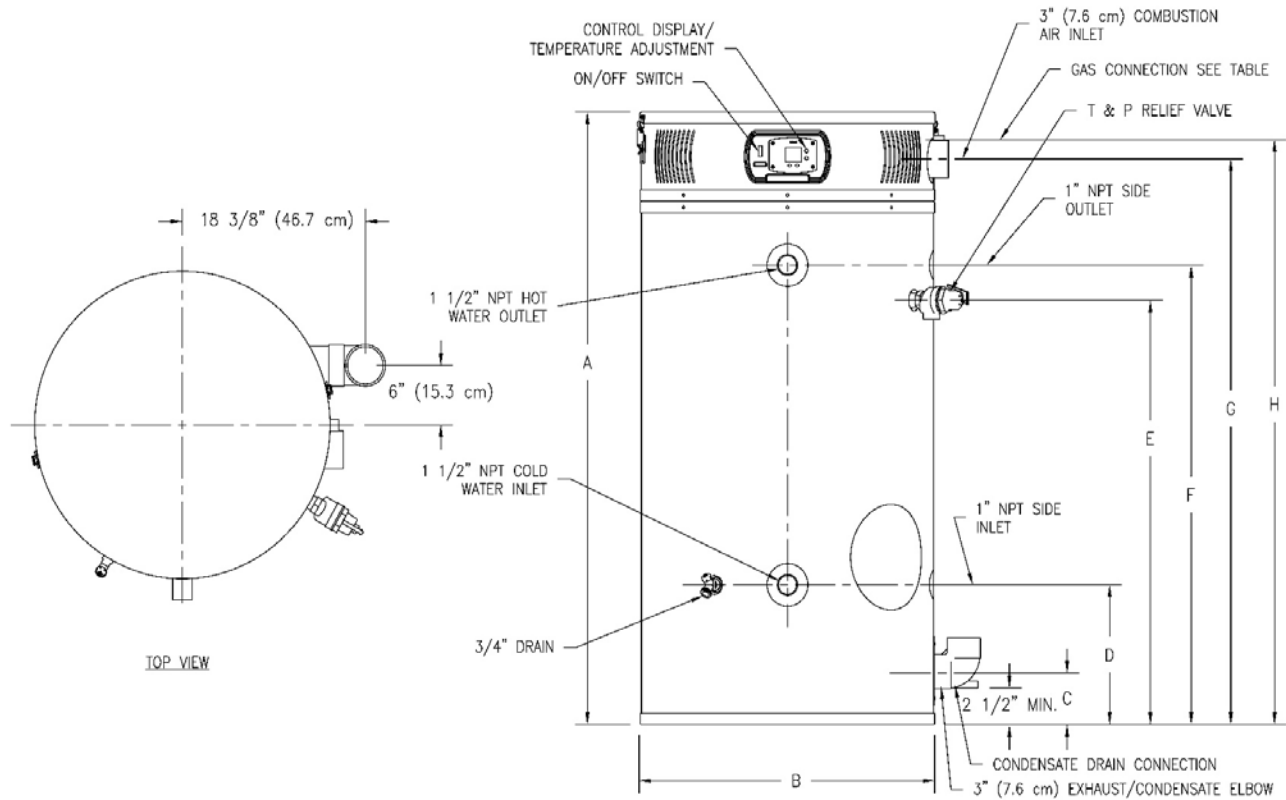

Model No.	Input Rate BTU/hr	1 st Hr. Del Gal @ 100 °F Rise	Recovery GPH at Degree Rise			Stg. Capacity US Gal	Therm. Efficiency %
			40°F	100°F	140°F		
60T125	125,000	187	363.6	145.5	103.9	60	96.0
60T150	150,000	211	422.7	169.1	120.8	60	93.0
60T199	199,999	265	557.6	223	158	60	92.0
100T150	150,000	250	450.5	180.2	129	100	97.0
100T199	199,999	309	597	238.8	171	100	97.0
100T250	250,000	364	734.8	293.9	210	100	96.0
100T300	300,000	405	836.4	334.5	239	100	92.0

Model No.	DIMENSIONS (INCHES)												
	A Height	B Dia.	C Floor to Vent Outlet	D Floor to Inlet Water Conn.	E Floor to T&P Valve Conn	F Floor to Outlet Water Conn	G Floor to Air Intake	H Floor to Gas Conn	Front Water Conn Dia	Space Heating Conn Dia	Gas Conn Dia (NPT)	T&P Valve Open (NPT)	Shipping Weight (lbs)
60T125	57	28 1/4	5	13	40	42 1/4	52 1/2	53 1/2	1 1/2	1	3/4	3/4	570
60T150	57	28 1/4	5	13	40	42 1/4	52 1/2	53 1/2	1 1/2	1	3/4	3/4	570
60T199	57	28 1/4	5	13	40	42 1/4	52 1/2	53 1/2	1 1/2	1	3/4	3/4	570
100T150	77 5/8	28 1/4	5	13	60	62 1/4	73 1/8	74 3/4	1 1/2	1	3/4	3/4	900
100T199	77 5/8	28 1/4	5	13	60	62 1/4	73 1/8	74 3/4	1 1/2	1	3/4	3/4	900
100T250	77 5/8	28 1/4	5	13	60	62 1/4	73 1/8	74 3/4	1 1/2	1	3/4	1	900
100T300	77 5/8	28 1/4	5	13	60	62 1/4	73 1/8	74 3/4	1 1/2	1	3/4	1	900

Icon System

Features of ICON System Module

- Water heater digital display on control board for setting and displaying the temperature setpoint. Pressing temperature UP and DOWN buttons changes the temperature setpoint. Temperature format may be displayed in °F or °C.
- Single control board with plug in wiring controls temperature, ignition, and blower operation.
- Plug in wiring reduces chance of miswiring.
- Burner ignition with direct spark ignition – A high voltage spark jumps from the spark rod to the burner surface to ignite the gas.
- Water heater digital display will show diagnostic codes in the event the water heater needs servicing. Aids in diagnosing and servicing the water heater.
- Water heater digital display can show previous error code history to further aid in servicing the water heater.

Power Supply	Dedicated 120 VAC, 60 Hz, 15A
Gas Supply	Minimum ¾" NPT (schedule 40 black iron pipe recommended)
Approved Gas Type	Natural or Propane. Unit must match gas type supplied.
Gas Pressure (Nat & L.P.)	Natural: 14" W.C. maximum static, 4.5" W.C. minimum running (recommended 7" W.C. min running) L.P. (Propane): 14" W.C. maximum static, 8" W.C. minimum running (recommended 11" W.C. min running)
Venting System	Power vent, balanced direct vent or unbalanced direct vent. See vent tables on page 8.
Approved Vent Materials	PVC, CPVC, Polypropylene, or Stainless Steel
Minimum Clearance for Servicing	18" from top, 24" from front, 4" sides and rear.
Maximum Water Supply Pressure	150 PSI
Thermostat Sensor	11,900 Ohms @ 70°F, ECO opens @ 207°F Max., ECO close @ 120°F Min. Redundant sensor for ECO. Sensor inside well for easy replacement of
Control Display	Digital display, 24 volts. Temperature Range: 70-180°F. Used to set tank temperature (°F or °C), show operating status, display error codes, error code history, limit maximum setpoint temperature.
Control Board	Operates from 24 volt from transformer. Controls tank temperature, ignition functions, combustion blower. See ignition timings in sequence of operation for ICON Control.
Transformer	120VAC primary, 24VAC secondary, 40VA.
Spark Rod Igniter	0.22" nominal gap to the burner surface.
Flame Sensor Output	Minimum 1 micro amp, typical range 5 to 30 micro amps.
Gas Valve	Negative regulation, 24 VAC, ½" PSI max., 4.5" W.C. Minimum running inlet.
Vent Safety Switch	Normally closed, opens @ 350°F, manual reset.
Blocked Vent Pressure Switch	24VAC, normally closed, opens when pressure increases to +2.70 W.C.
Blower	120VAC, 60Hz, 1-4 amps

Sequence of Operation

1. Thermostat calls for heat.
2. Combustion blower starts at a reduced rpm for a “soft” start light off.
3. Blower pre-purge period of approximately 15 seconds.
4. Ignition control board runs an internal verification safety check for approximately 15 seconds.
5. Trial for ignition (approximately 5 seconds per trial, 3 trials total):
 - a. Spark establishing period (3 seconds), gas valve opens, sparks from spark rod to ground rod, igniting the fuel air mixture at the burner surface.
 - b. Burner on, flame proving period (2 seconds). Requires a minimum of 1 microamp through the flame sense rod to prove flame.
 - c. If the blocked vent pressure switch contacts (normally closed) are open, then the ignition sequence will not start and error code “67” (pressure switch failed to close/open or vent safety switch failed to close/open) will flash once on the digital display. The unit will then go into pre-purge/“Hold” while the unit is waiting for the issue to be corrected. If the issue continues to occur, the digital display with flash error code “137” (pressure switch is open, or vent safety switch is open) while the unit is waiting to restart (5 minutes) the normal sequence of operation.
6. Once the flame signal is verified, the blower will remain at the “soft” start RPM for 5 seconds to stabilize the flame.
7. Steady state operation – Burner continues to operate until:
 - a. The thermostat circuit opens, gas valve closes, and blower continues to operate for 30 second post-purge period.
 - b. If the blocked vent pressure switch contacts open (normally closed) while the burner is on, then the gas valve closes, and the unit will retry a normal sequence of operation. If issue remains on restart, the unit will go into recycle as described in 5c.
8. Thermostat is satisfied.
9. Gas valve closes and burner is extinguished.
10. Blower post purge for 30 seconds at maximum RPM.

Sequence of Operation

Lockout Conditions

The system will go into lock out mode for the following reasons:

1. ERROR CODE 110

- a. Control board will go into soft lockout if the main burner cannot be lit or fails to prove flame after 3 ignition trials. The water heater digital display indicates a lockout condition by showing error code 110 with "Service Needed" on the control board's digital display. Refer to error codes in the diagnostic section of this Service Manual. In a soft lockout condition, the control will wait for 15 minutes and then make 3 more attempts to light the main burners. Soft lockout reset is accomplished by depressing the lower right button under "Reset" for 3 seconds.

2. ERROR CODE 80

- a. If the temperature at the top of the tank should exceed 207°F, then the high limit control will shut off the burner and the water heater will go into a hard lockout. Error code 80 will be shown on the control board's digital display. The control board can only be reset in the Service Mode, which is detailed in the ICON System Troubleshooting section of this Service Manual (pg 15).

3. ERROR CODE 67

- a. If the exhaust terminal becomes blocked or the condensate elbow fails to drain condensate, the normally closed exhaust pressure switch will open, the gas valve will close, and error code 67 will appear on the digital display. When the condition is corrected, the error code will disappear, and the water heater will resume normal operation. No resetting of the control board is needed for the pressure switch error code.
- b. If the vent safety switch located near the exhaust pressure switch should open, the gas valve will close, the blower will post-purge, and error code 67 will appear on the control board's digital display. The lockout condition will reset once the problem is corrected and the switch is reset. Refer to Vent Safety Switch Testing and Replacement in this Service Manual (pg 49).
- c. The pressure switch and temperature switch are wired in series. As a result, the water heater will not function unless both switches are operational.

Building Management System (BMS)

All water heaters with ICON Systems can be equipped with a gateway kit that will facilitate a Building Management System (BMS) connection to Modbus or Bacnet®. This kit is sold separately and is not factory installed. A full installation, operation, and troubleshooting manual is provided with the gateway kit.

⚠ CAUTION

Before beginning any Troubleshooting operations listed below, please note that the gateway kit and BMS may need to be disconnected from the heater. Please ensure this has been completed before proceeding with any troubleshooting operation that may be impacted by settings in the BMS.

BMS Mapping

Map Descriptor Name	Modbus Register	Read/Write	BACnet Object ID	Note
Demand source	00006	Read	001	Current demand source: 0 = Unknown 1 = No source demand 2 = CH 3 = DHW 4 = Lead Lag slave 5 = Lead Lag master 6 = CH frost protection 7 = DHW frost protection 8 = No demand due to burner switch (register 199) turned off 9 = DHW storage 10 = Reserved 11 = Warm weather shutdown 12 = Hot standby
Firing rate	00008	Read	002	Actual firing rate (% or RPM)
Fan speed	00009	Read	003	RPM
Flame signal	00010	Read	004	0.01V or 0.01 μA precision (0.00-50.00V)
Tank temperature sensor	00012	Read	005	-40°-130° (0.1°C precision)
Appliance setpoint	00017	Read	006	-40°-130° (0.1°C precision)
Burner status	00032	Read	007	0 = Disabled 1 = Locked out 2-3 = Reserved 4 = Anti-short cycle 5 = Unconfigured safety data 6-33 = Reserved 34 = Standby Hold 35 = Standby Delay
Lockout code	00034	Read	008	0 = No lockout 1-4096
Appliance status	00080	Read	009	0 = Unknown 1 = Disabled 2 = Normal 3 = Suspended
DHW priority count	00082	Read	010	Countdown of time when DHW has priority over CH (secs). Applicable when DHW priority time is enabled.
Burner run time	00130/00131	Read	011	Hours
Controller cycle count	00142/00145	Read	012	0-999,999
Controller run time	00144/00145	Read	013	Hours
Alarm reason	0035	Read	014	0 = None 1 = Lockout 2 = Alert 3 = Other
DHW setpoint	0453	Read/Write	015	40°-130° (0.1°C precision)

BMS Wiring Diagram

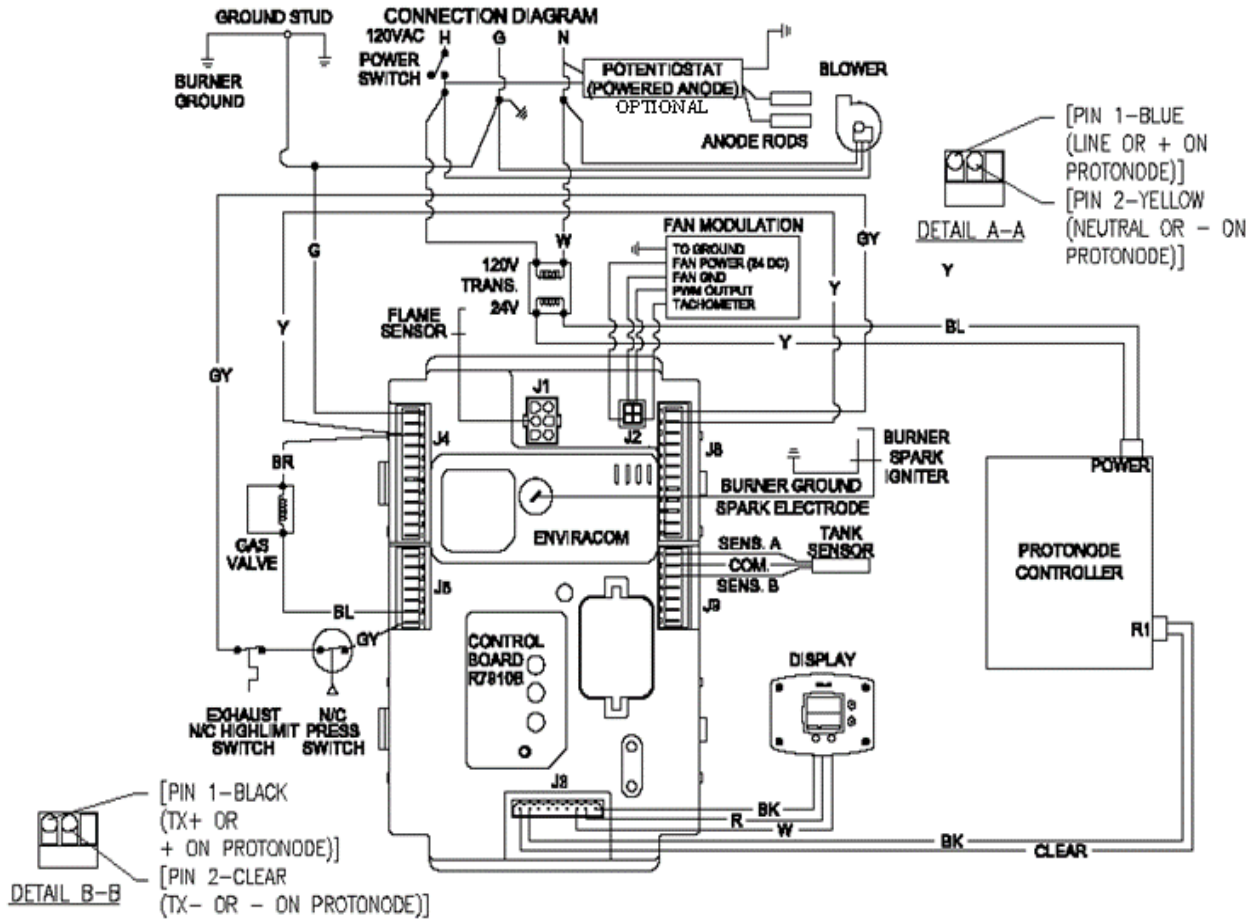

NOTICE

The Building Management System (BMS) is only compatible with units that have ICON controllers.

Part	Bradford White Part Number
BMS Gateway Installation Kit	415-53943-00

Troubleshooting

System Observation

Water Heater Fault: Water heater does **NOT** operate.

Display Error Code: Water heater digital display does **NOT** operate - blank display.

Check main power supply to water heater.
Check fuse, circuit breaker, plug receptacle, line cord, and wiring to water heater.

Check to make sure switch on front of control board is in the ON position.

Verify primary voltage at the transformer.

Refer to control board illustration. Voltage at transformer across **black** and **white** wires should be 110-120 VAC. Verify 120V from the power switch.

Verify secondary voltage at the control board.

Refer to control board illustration. Voltage at connector location J8 across **blue** and **yellow** wires should be 24-28 VAC. If not, check transformer. Replace transformer if defective.

Does the water heater digital display operate? Increase thermostat setting if tank is warm.

Digital display operates— see next page.

Is 24-28 VAC present between **red** and **black** wire pin connections located on the front of the control board terminal J3?

Replace digital display.

Check wires for proper termination to control board. Are wire terminations connected properly to digital display?

Check wire harness for proper continuity.

Replace control board.

⚠ WARNING

120 volt potential exposure. Use caution making voltage checks to avoid personal injury.

⚠ CAUTION

Use caution to **NOT** damage connectors when making voltage measurements or jumping terminals.

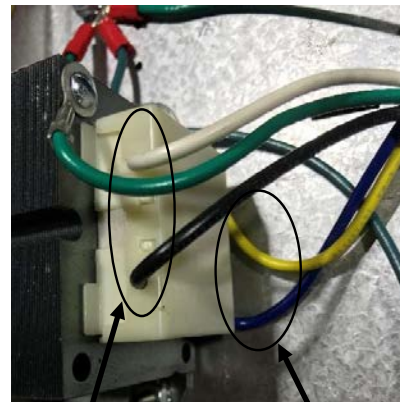

Black & White wires

Yellow & Blue wires

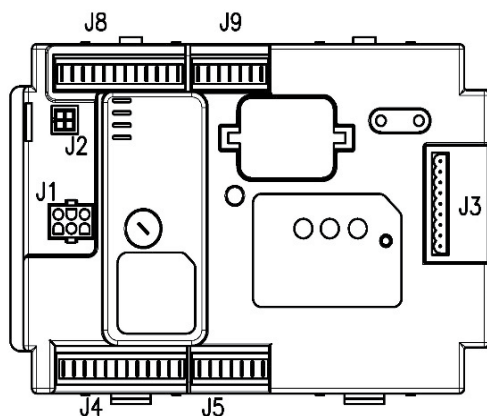

ICON Control Board Schematic

Troubleshooting

⚠ CAUTION

Use caution to **NOT** damage connectors when making voltage measurements or jumping terminals.

⚠ WARNING

120 volt potential exposure. Use caution making voltage checks to avoid personal injury.

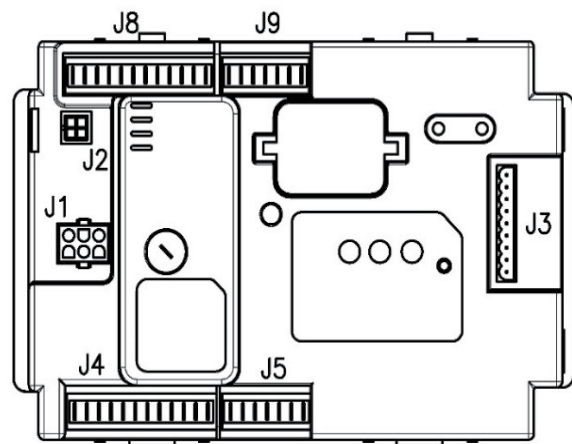
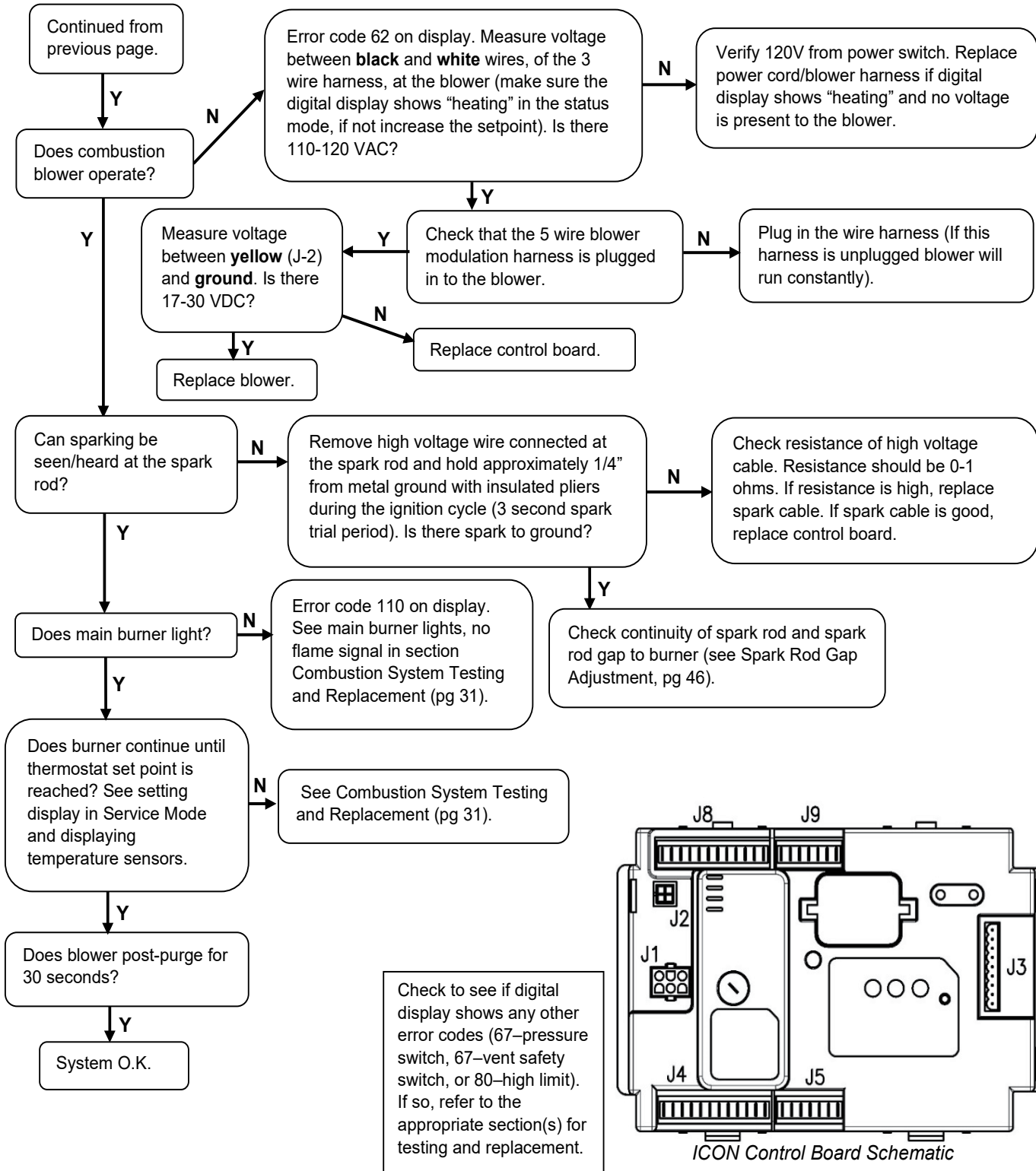

ICON Control Board Schematic

Display Control

Water Heater Display and Control Buttons

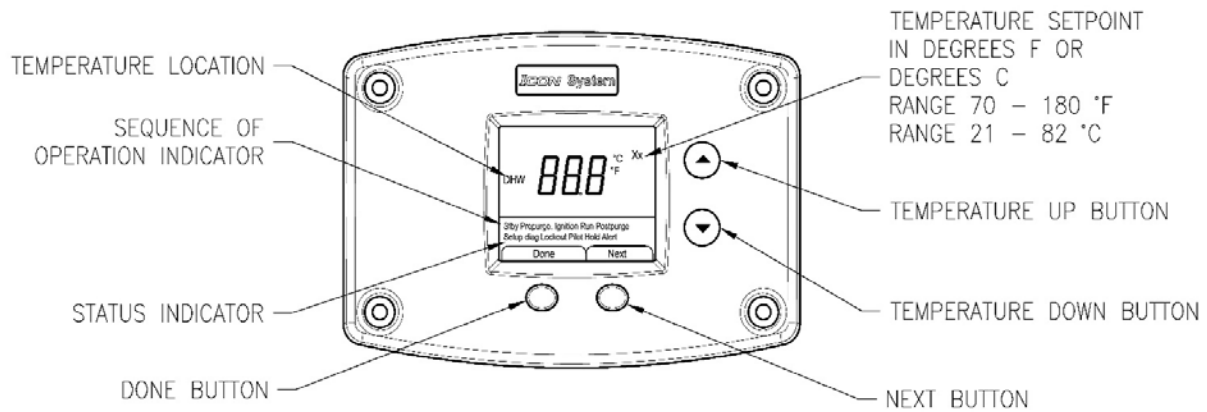

To Increase Temperature Setpoint

Step 1. Press and hold “Temperature Up” button until desired setpoint temperature appears on the display.

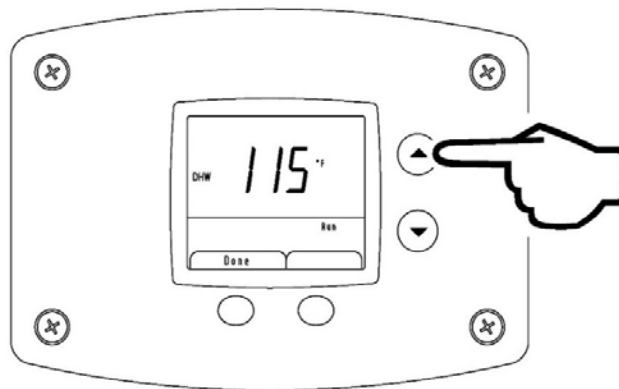

Step 2. Press “DONE” button for new setting to take effect immediately. If the “DONE” button is not pressed, the new temperature setting will take effect in approximately 10 seconds.

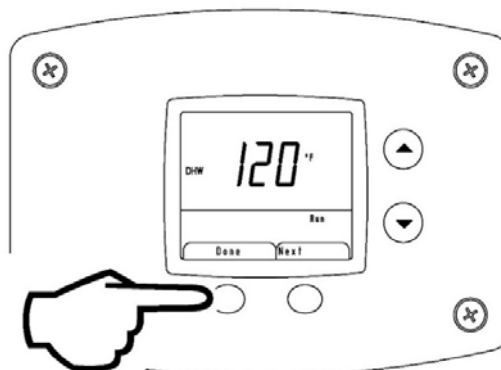

PRESS DONE BUTTON FOR SETTING TO TAKE EFFECT IMMEDIATELY

To Decrease Temperature Setpoint

Step 1. Press and hold “Temperature Down” button until desired setpoint temperature appears on the display.

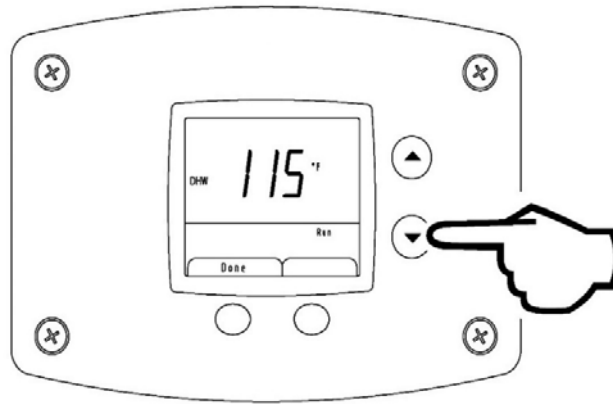

Step 2. Press “DONE” button for new setting to take effect immediately. If the “DONE” button is not pressed, the new temperature setting will take effect in approximately 10 seconds.

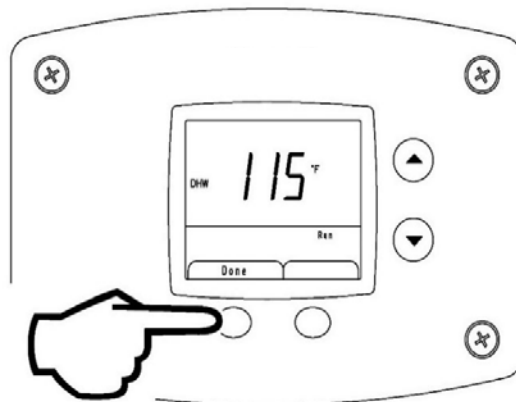

PRESS DONE FOR SETTING TO
TO TAKE EFFECT IMMEDIATELY

To View Combustion Rate

Step 1. Select Next while viewing DHW Setpoint in User Mode to access Rate screen. Rate will only be displayed while the burner is operating.

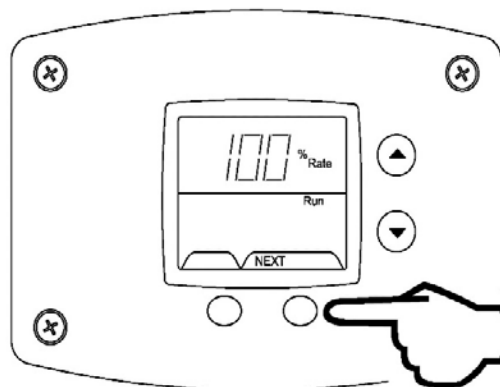

Step 2. Select Next to go back to the DHW Setpoint screen.

To Change Temperature Format in Display from °F to °C or °C to °F

Step 1. Enter "Set-Up Mode" by pressing both UP/DOWN buttons together for 3 seconds.

Step 2. Use the arrows to select between °F and °C

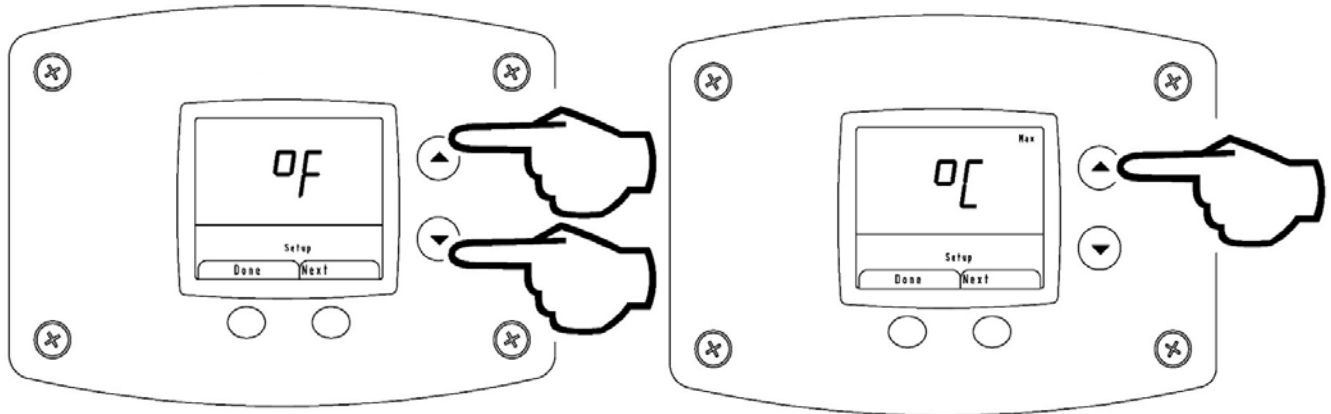

Step 3. Press done to return to main screen or timeout/change will occur in one minute.

An energy cut out (ECO) is incorporated in the sensor and control board which will shut off all gas supply to the burner if the water heater temperature exceeds 207°F (93°C). Should the ECO function (open), the water temperature should be reduced to approximately 120°F (49°C) and call a qualified service agent to place the water heater in operation. The water heater must have the problem corrected by a qualified service person before putting the water heater back in operation. It is recommended that all service work be performed by a qualified service agency.

If the water heater is to remain idle for 30 days or more or is subjected to freezing temperatures while shut off, the water heater and piping should be fully drained (See "To Drain the Water Heater") and the drain valve should be left fully open.

WARNING

Hydrogen gas can be produced in an operating water heater that has not had water drawn from the tank for a long period of time (generally two weeks or more). **HYDROGEN GAS IS EXTREMELY FLAMMABLE.** To prevent the possibility of injury under these conditions, we recommend the hot water faucet to be open for several minutes at the kitchen sink before you use any electrical appliance which is connected to the hot water system. If hydrogen is present, there will be an unusual sound such as air escaping through the pipes as hot water begins to flow. **DO NOT smoke or have open flame near the faucet at the time it is open.**

WARNING

DO NOT run out of propane gas. Damage to the water heater may occur.

Troubleshooting

Accessing Diagnostic Mode on the Water Heater Display

(FOR SERVICE PERSONNEL ONLY)

The display has a Diagnostic Mode to access information in aiding servicing of the water heater. This procedure is for service and installation personnel only. To enter the Diagnostic Mode, follow the steps illustrated below:

WARNING

The following procedure is for **service and installation personnel ONLY**. Resetting lockout conditions without correcting the malfunction can result in a hazardous condition.

Step 1. Press and hold the lower right button under “Next” in the lower right display for at least 3 seconds. You must be in user mode on the DHW temp screen to access diagnostic mode. If in user mode on the view rate screen, you cannot access diagnostic mode.

NOTICE

The screens will stay in the Diagnostic Mode for 12.5 minutes after the last button press for viewing unless “Done” button is pressed to exit Diagnostic Mode.

Step 2. In the first screen of diagnostic mode the display will show the flame sense current in microamps when the burner is operating.

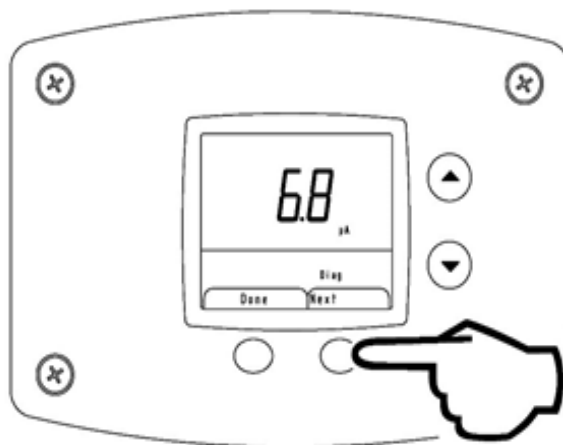

PRESS NEXT BUTTON FOR
3 SECONDS TO ENTER

Step 3. Press the lower right “Next” button. The display will flash and show the number of any alert codes. These are **not** currently used.

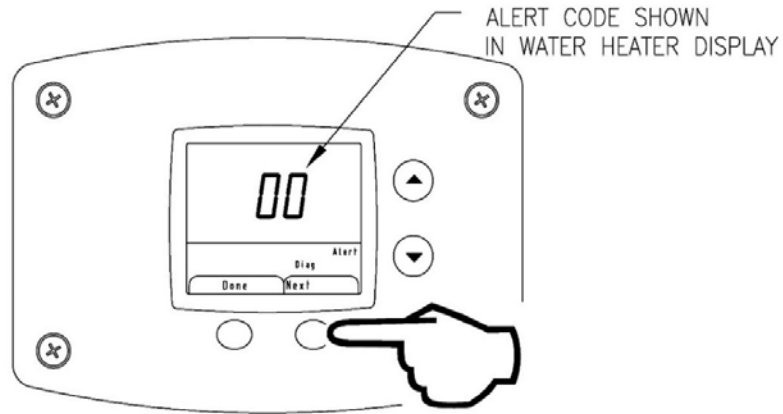

Step 4. Press lower right “Next” button. The display will flash and show the number of any Lockout codes. If there are no lockouts, the display will show 00. If there are multiple lockout codes “Next” will scroll through them.

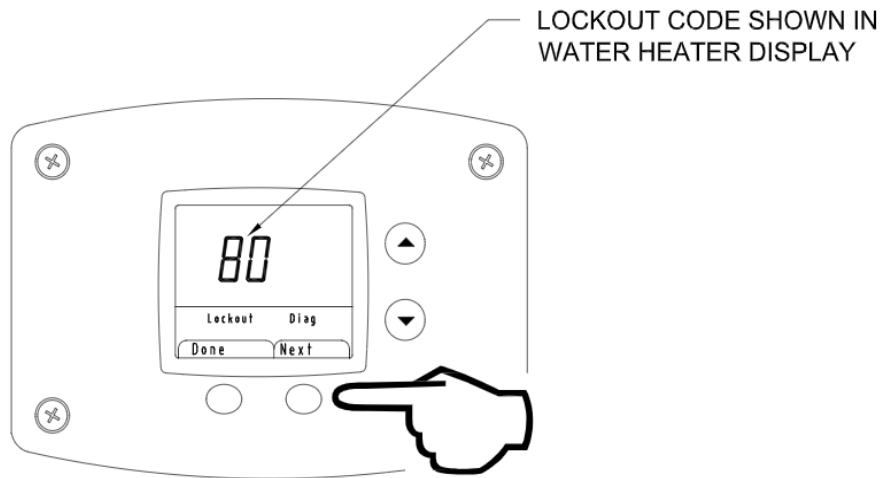

Step 5. Press “Next”, the display will show “DHW MAX”. This is the maximum allowable temperature that the unit can get to before a lockout occurs.

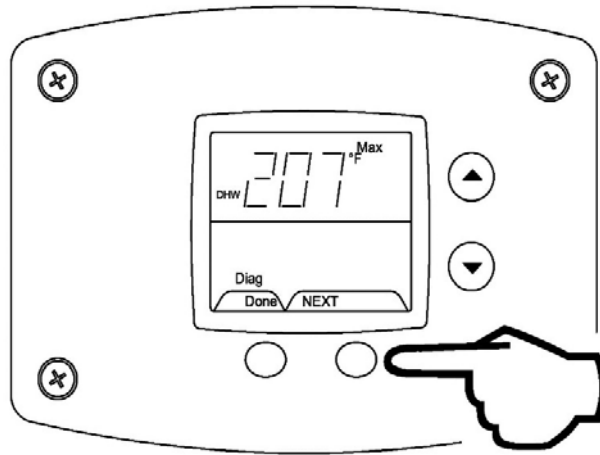

Step 6. Press Next, display will show “DELTA T DHW”, this is the real time temperature reading of the tank.

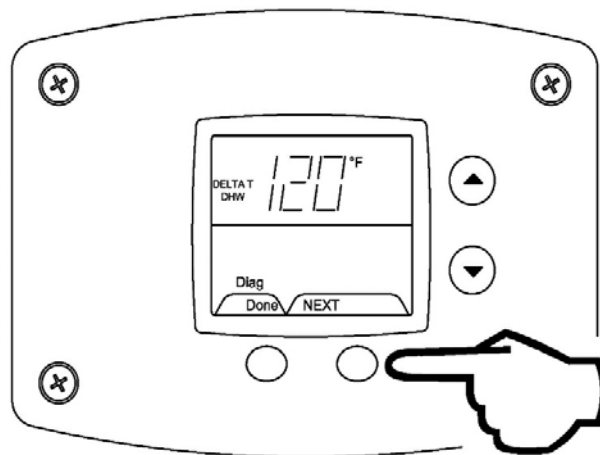

Step 7. Press “Done” to exit Diagnostic Mode and return to the DHW setpoint in User Mode.

DIAGNOSTIC ERROR CODES AND TROUBLESHOOTING PROCEDURES FOR EF MODELS WITH ICON SYSTEMS CONTROL

NOTICE

The ICON control system can produce soft and hard lockouts. Soft lockouts are displayed if active and are not stored in Diagnostic Mode history. The control will periodically attempt to resume normal operation when in soft lockout conditions. If the system resumes normal operation a soft lockout will clear instantly; hard lockouts will display if active and require manual reset. Up to ten previous Hard lockouts are logged chronologically (newest first) in Diagnostic Mode history.

Error Code	Definition of Code	Cause of Problem and Actions Taken to Correct
No code – blank display	No power to the unit or switch is off.	<ul style="list-style-type: none"> • Check power supply to the water heater. • Make sure water heater is plugged in and the breaker is on. • Check if there is 120 volts power supply to the LINE connections on the control board. • Verify 24 volts at display. • Check for loose wires, defective transformer. • Check wire harness connections from display to the control board.
9,22	Low flame sense signal	<ul style="list-style-type: none"> • Check microamp output of flame sense • Inspect flame sensor and wire • Inspect burner for debris
49	Voltage too low or high	<ul style="list-style-type: none"> • Measure the incoming line voltage. • Voltage should be 115-125 volts. • If the voltage is not within this range or there is drastic fluctuation, then have the incoming power supply checked. • If the line voltage is satisfactory, check the output from the transformer to make sure it is 22-26 volts. • Replace transformer or wiring if defective.
53	AC Inputs phase reversed	<ul style="list-style-type: none"> • Check the module and display connections. • Check the module power supply and make sure that frequency, voltage and VA capacity of the transformer meet specifications. • Check to make sure the wiring connections on the control module from terminals J4-10 and J8-2 are connected together.
62	Fan speed not proved	<ul style="list-style-type: none"> • Check the pulse width modulation (PWM) wire harness connection from the blower to the control module. • Make sure the pin terminals make solid contact. • Measure the resistance of each wire in the wire harness from the terminal ends. • Replace wire harness if defective. • If value remains out of range, this hold will change to lockout 123 (defined below)
67	Normally closed vent safety circuit opened	<ul style="list-style-type: none"> • Check wiring to the normally closed blocked vent pressure switch and vent limit switch. • Use a voltmeter to find out if either the pressure switch or the high limit switch has opened. • If so, determine the cause (blocked vent terminal, clogged condensate drain, high temperature in compartment). • If limit switches are closed, check wiring for shorts. • Measure continuity. • If limit switches and wiring check O.K., replace control module.

Error Code	Definition of Code	Cause of Problem and Actions Taken to Correct
80	High Limit (Overheat Condition)	<ul style="list-style-type: none"> • Check the wiring from the water temperature sensor to the control module. • Measure the resistance of each outside wire to the center wire. Measure the tank temperature and compare with the chart below. • If either outside wire has a much different resistance reading, replace the sensor. • Make sure the sensor is securely held inside the well with the clip. • If the problem persists and the sensor and wiring check O.K., then replace the control module.
93	Water temperature sensor fault	<ul style="list-style-type: none"> • Appears after alert 172, defined below. • Check the water temperature sensor wire harness from the sensor to the control module. • Make sure there are no loose connections to the control plug. • Check the resistance reading from each of the outside wires to the center (common) wire. Measure the tank temperature and compare with the chart below. • If the ohm readings are not fairly close, replace the sensor. • Replace the control module if the problem persists and the sensor and wire connections are not defective.
105	Flame detected out of sequence	<ul style="list-style-type: none"> • Check to see if flame is present inside the combustion chamber before or after the ignition cycle. • If so, check to make sure the gas valve is wired correctly. • Check for voltage at the gas valve connection. • Replace the gas valve if defective. • If no flame is visible outside of the ignition sequence/run cycle, then make sure the flame sensor is wired to the correct terminal. • Make sure the ignition cable is not crossing the flame sensor wire or ignition ground wires. • If problem persists and all other checks have been verified, replace the control module.
109, 110	Ignition Failure Occurred.	<ul style="list-style-type: none"> • Burner failed to light or stay lit after 4 retries. • Hold condition – will reattempt ignition after 15 minute waiting period. A log will be stored in service history. • Check gas valve wiring and gas valve operation during the ignition cycle. • If burner lights but quickly goes out, check the flame sensor wire or the flame sensor. • If the flame sensor rod is badly corroded with deposits, clean with sandpaper or replace. • Check the inlet gas supply to make sure the pressure is sufficient and does not drop after the gas valve opens. • Make sure the combustion blower is operating during the ignition and run cycle. • Check the venting system to make sure the inlet and exhaust terminals and venting system is not blocked.
122,123	Light-off Rate Proving Failed	<ul style="list-style-type: none"> • If blower speed is not verified from the PWM (Pulse Width Modulation) signal within 5 minutes, the previously described error code “62” changes from a hold condition to this lockout code condition • Check the harness and pin terminals for a good connection to the control module. • Replace the blower or control module if the wire harness is good.
137	Normally closed vent safety	<ul style="list-style-type: none"> • Refer to code 67

Error Code	Definition of Code	Cause of Problem and Actions Taken to Correct
	circuit opened	
172	Water temperature sensor resistance invalid	<ul style="list-style-type: none"> • Hold 93 will be displayed if this value remains out of range • Measure the resistance of the water temperature sensor and compare it with the tank temperature using the chart below (Reference Appendix A - Sensor Resistance at Various Temperatures on pg. 29).
NOTE		<ul style="list-style-type: none"> • If there is no display, check primary/secondary voltage • Before troubleshooting always verify the following <ul style="list-style-type: none"> ○ Gas inlet pressure ○ Static to dynamic gas pressure drop ○ No vent and intake restrictions ○ All wire connections are tight ○ No grounded wires or missing grounds ○ No water leaks

Service Procedure I

Thermostat Circuit Testing and Replacement

IMPORTANT NOTE: This procedure assumes a cool tank.

Condition: Water heater not operating. Digital display shows error code 93 (sensor reading faulty).

Unplug or disconnect electrical power to the water heater.

Check continuity of wire harness to sensor. Resistance of harness should be close to 0 ohms. Replace wire harness if high resistance is measured (over .5 ohms). Check wires for intermittent connections, shorts, and/or frayed insulation. Replace if necessary.

If wire harness is O.K., check sensor resistance detailed in Appendix A: Sensor Resistance at Various Temperatures (pg 29). Replace sensor if needed.

Turn power ON to water heater. Run water heater through heating cycle and verify proper operation. Sensor temperature can be viewed when burner shuts off (see section on viewing the digital display in Service Mode).

Condition: Water heater not operating. Digital display shows error code 80 high water temperature (over 207°F).

⚠ WARNING

DO NOT reset the digital display from the hard lockout state without correcting the cause of the overheating condition.

Turn power OFF. Draw water to cool tank below 120°F.

Check sensor. Sensor is held in place with a clip fastened to the well (see image). Check sensor wire for potential damage or breaks in the wire insulation. Is the sensor fully inserted into the well?

If sensor clip is damaged replace clip. Replace sensor if damaged.

Continued on next page.

Check sensor resistance (see Appendix A: Sensor Resistance, pg 29).

⚠ WARNING

120 volt potential exposure. Use caution making voltage checks to avoid personal injury.

⚠ CAUTION

Use caution to **NOT** damage connectors when making voltage measurements or jumping terminals.

Checking continuity of sensor across the two black wires (disconnected from control board)

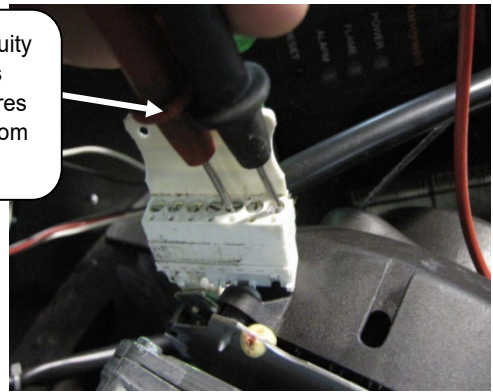

Sensor clip shown properly installed



The sensor is located next to the top outlet location

Service Procedure I

Thermostat Circuit Testing and Replacement (Continued)

Continued from previous page.

Condition: Water heater not operating. Digital display shows error code 80 high water temperature (over 207°F) (continued from previous page).

Once cause of overheating condition has been diagnosed and corrected, the control board may be reset.

- Reconnect and switch on power to the water heater.
- Press button under "Reset" and hold for 3 seconds.
- Set thermostat to the desired setting.
- Water heater will start.
- Monitor temperatures for one complete heating cycle making sure the maximum tank temperature remains below 207°F.

WARNING

DO NOT operate the water heater without verifying that the overheating condition has been corrected.

This water heater is equipped with a manual reset type gas shutoff device designed to shut off the gas to the burners if excessive water temperature occurs. To reset the control, press the lower right button under "RESET" in the display for 3 seconds.

— Error code 80 indicates high limit lockout condition

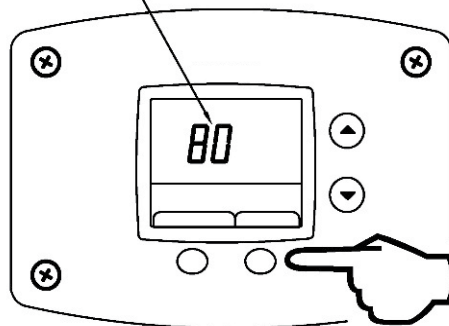

Step 1: Press for 3 seconds to reset control.

Service Procedure I

Thermostat Circuit Testing and Replacement (Continued)

Thermostat Sensor (Thermistor) Replacement Procedure

1. Position main power switch to "OFF."
2. Disconnect (unplug) water heater from 120 volt power source.
3. Unlatch and remove top surround cover from top of the water heater.
4. Fold back insulation by top outlet location to expose temperature sensor.
5. Disconnect temperature sensor from control board (see images below).
6. Unclip sensor from well and pull sensor to remove, **DO NOT** remove well.
7. Install new sensor completely into well and reinstall sensor clip.
8. Connect temperature sensor to control.
9. Fold insulation back into place. Be sure there are **NO** wires in contact with burner.
10. Restore 120 volt power supply and water supply to water heater, check and repair any leaks found. Confirm proper operation following the lighting instructions on the lighting instruction label, or the lighting instructions located in the Installation and Operating Manual.
11. Replace the surround cover on the top of the water heater.

WARNING

120 volt potential exposure. Use caution making voltage checks to avoid personal injury.



Disconnect sensor harness from control board



Sensor clip shown properly installed

Service Procedure I

Thermostat Circuit Testing and Replacement (Continued)

Appendix – A Sensor Resistance at Various Temperatures

Be careful when making voltage measurements or jumping terminals NOT to damage or deform connectors or connector pins.

Draw water from the Temperature and Pressure Relief Valve. Compare the Temperature with Temperature Ohms Chart below.

Example: If temperature of the sensor is 84 °F, then the resistance through the sensor would be 8449 (see shaded area).

NOTE: Sensor resistance increases as the temperature falls.

In Degrees F										
°F	0	1	2	3	4	5	6	7	8	9
40	26109	25400	24712	24045	23399	22771	22163	21573	21000	20445
50	19906	19383	18876	18383	17905	17440	16990	16553	16128	15715
60	15314	14925	14548	14180	13823	13477	13140	12812	12494	12185
70	11884	11592	11308	11032	10763	10502	10248	10000	9760	9526
80	9299	9078	8862	8653	8449	8250	8057	7869	7685	7507
90	7333	7165	7000	6839	6683	6531	6383	6238	6098	5961
100	5827	5697	5570	5446	5326	5208	5094	4982	4873	4767
110	4663	4562	4464	4368	4274	4183	4094	4006	3922	3839
120	3758	3679	3602	3527	3453	3382	3312	3244	3177	3112
130	3048	2986	2925	2866	2808	2752	2697	2643	2590	2538
140	2488	2439	2391	2344	2298	2253	2209	2166	2124	2083
150	2043	2004	1966	1928	1891	1856	1820	1786	1753	1720
160	1688	1656	1625	1595	1566	1537	1509	1481	1454	1427
170	1402	1376	1351	1327	1303	1280	1257	1235	1213	1191
180	1170	1150	1129	1110	1090	1071	1053	1035	1017	999
190	982	965	949	933	917	901	886	871	857	842
200	828	814	801	788	775	762	749	737	725	713

Service Procedure I

Thermostat Circuit Testing and Replacement (Continued)

Thermostat Sensor (Thermister) Replacement Procedure

1. Position main power switch to OFF.
2. Disconnect (unplug) the water heater from 120 volt power source.
3. Unlatch and remove the top of the surround cover from the top of the water heater.
4. Fold back the insulation just in front of the burner to expose the temperature sensor (see image at right).
5. Disconnect temperature sensor from harness (see images at right).
6. Unclip the sensor from the well and pull the sensor to remove, do NOT remove the well.
7. Install the new sensor completely into the well and reinstall the sensor clip.
8. Fold the insulation back into place. Be sure there are no wires in contact with the burner.
9. Restore 120 volt power supply and water supply to the water heater, check and repair any leaks found. Confirm proper operation following the lighting instruction label or the lighting instruction located in the Installation and Operating Instruction Manual.
10. Replace the surround cover on the top of the water heater.

⚠ WARNING

120 volt potential exposure. Isolate the appliance and reconfirm power is disconnected using a multi-meter.

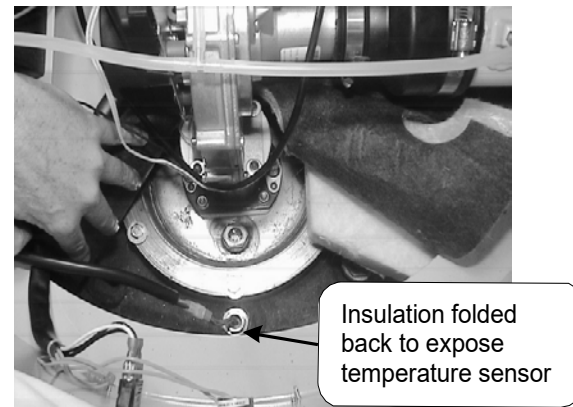
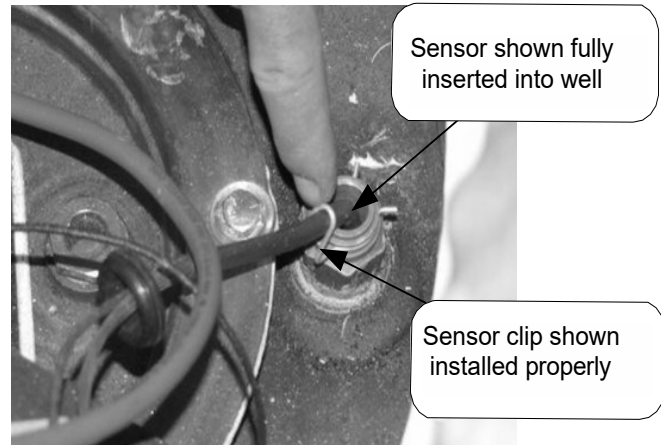

Service Procedure II

Combustion System Testing and Replacement

Observe burner operation through the sight glass located on the combustion insert mounting flange. Normal burner operation should ignite smoothly, without evidence of coughing or huffing upon ignition. The burner flame should be a blue flame near the burner surface in a uniform flame pattern. Occasional yellow or white streaks are normal.

Note: On higher input models using metal fiber mesh burner a red glow from the burner surface is normal.

⚠ WARNING
120 volt potential exposure. Use caution making voltage checks to avoid personal injury.

⚠ WARNING
Removing screw from inlet gas pressure tap will immediately allow gas to flow from pressure tap.

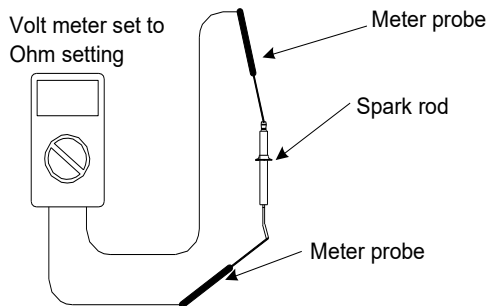
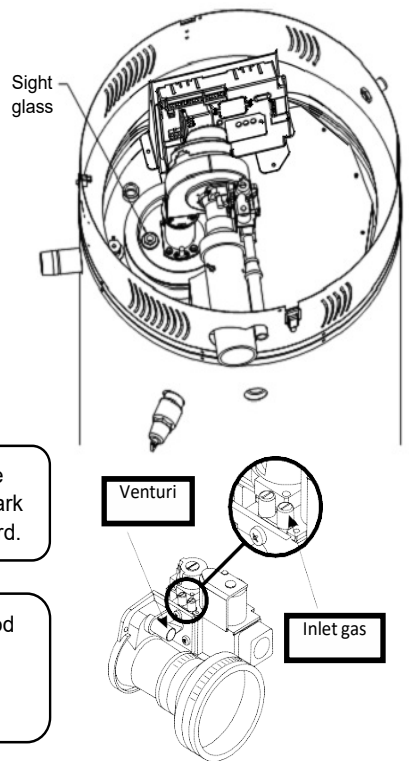
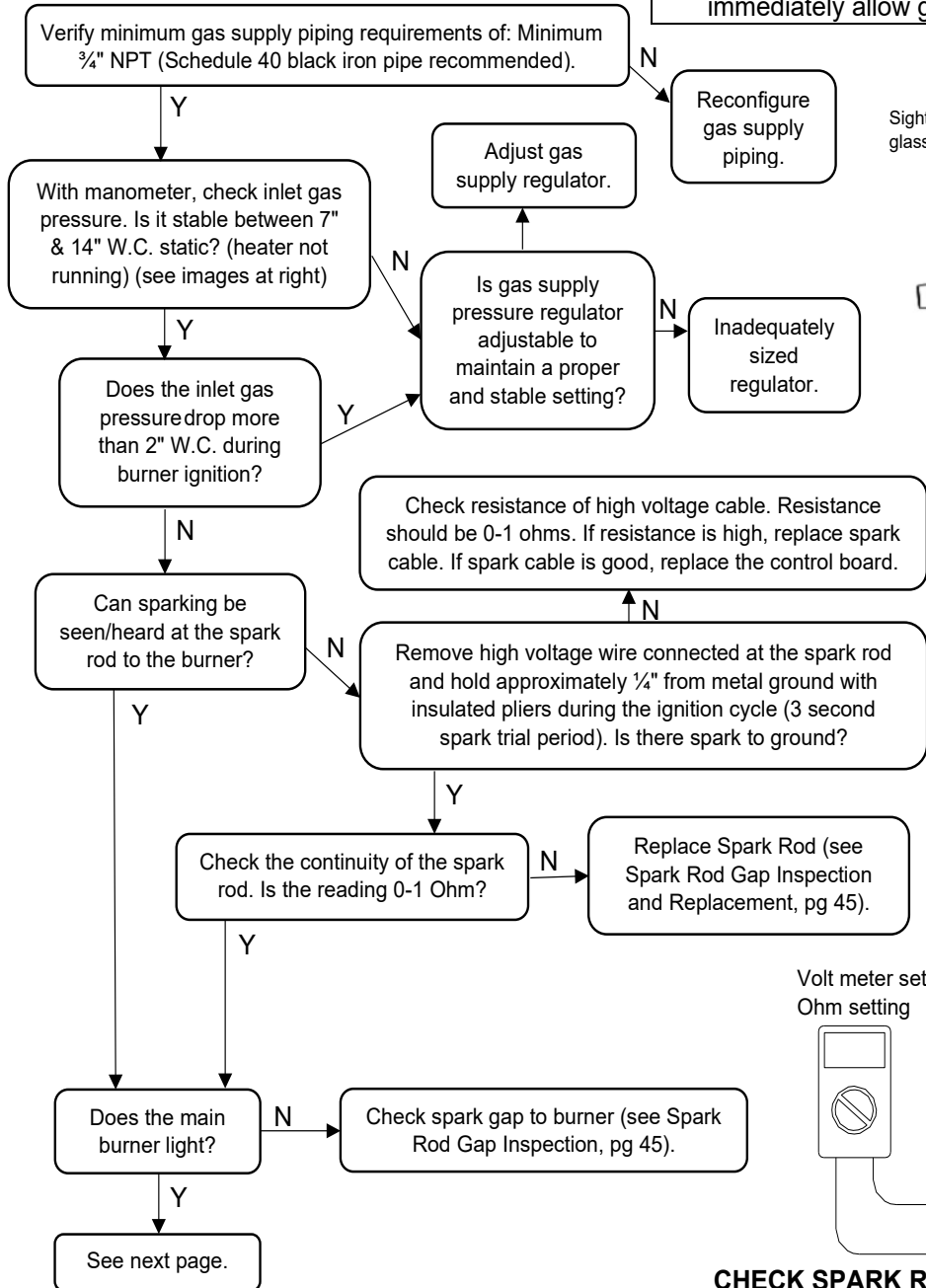

CHECK SPARK ROD RESISTANCE

Service Procedure II

Combustion System Testing and Replacement (Continued)

Observe burner operation through the sight glass located on the combustion insert mounting flange. Normal burner operation should ignite smoothly, without evidence of coughing or huffing upon ignition. The burner flame should be a blue flame near the burner surface in a uniform flame pattern. Occasional yellow or white streaks are normal.

⚠ WARNING

120 volt potential exposure. Isolate the appliance and reconfirm power is disconnected using a multi-meter.

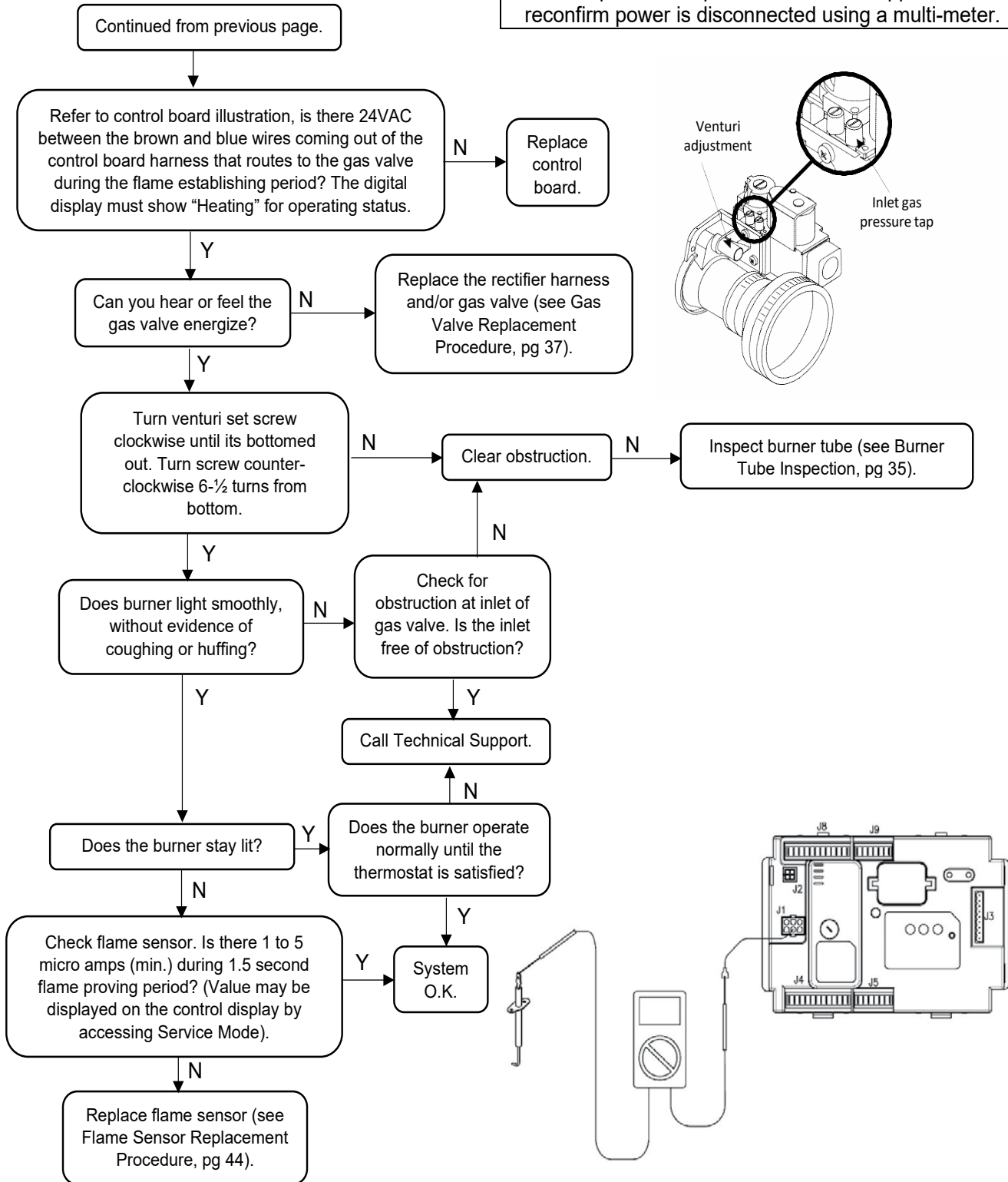

Service Procedure II

Combustion System Testing and Replacement (Continued)

Combustion System Removal Procedure

1. Position main power switch to OFF.
2. Disconnect (unplug) water heater from 120 volt power source.
3. Turn OFF gas supply to the water heater.
4. Unlatch and remove the surround cover from the top of the water heater.
5. From the gas valve, disconnect the gas connection, PVC venting, silicone tubing, and wire harness.
6. Disconnect the wire harnesses, flame sensor, and blower. Then disconnect the high voltage cable from the spark rod connection.
7. Remove the 5 bolts (1/2" socket) holding the burner mounting insert in place.
8. Carefully remove combustion assembly with gasket from the water heater.
9. See next page for combustion system installation procedure.

⚠ WARNING

120 volt potential exposure. Isolate the appliance and reconfirm power is disconnected using a multi-meter.

⚠ WARNING

Heater components may be HOT when performing the following steps in this procedure. Take necessary precaution to prevent personal injury.

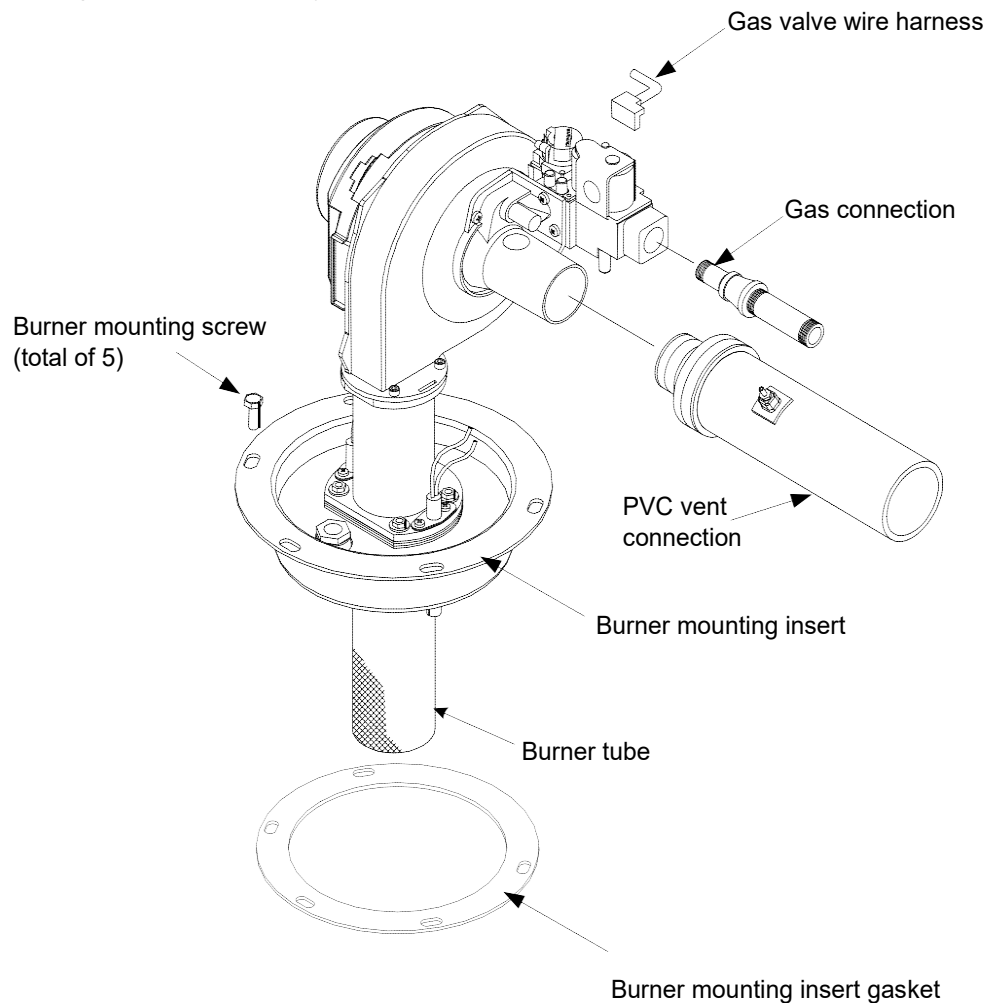

Service Procedure II

Combustion System Testing and Replacement (Continued)

Combustion System Removal Procedure

1. Fully inspect burner mounting insert gasket for the following:
 - a) Tears
 - b) Missing material
 - c) Cracks
 - d) Dirt or debris
 - e) Other imperfections that would inhibit proper seal

If gasket is NOT affected by any of the above, gasket replacement is not required.

2. Install combustion assembly using new gasket or fully inspected gasket from step 1. Secure combustion assembly at the burner mounting insert using screws from step 6 on previous page. Tighten screws evenly.
3. Reconnect wire harnesses to igniter or high voltage cable to spark rod, flame sensor, blower, and gas valve.
4. Reconnect PVC venting, gas supply and silicone tubing to gas valve. Turn on gas supply to heater and check for gas leaks, repair any gas leaks found.
5. Restore 120 volt power supply to water heater and confirm proper operation following the lighting instructions on the lighting instruction label or the lighting instruction located in the Installation and Operating Instruction Manual.
6. Replace the surround cover on the top of the water heater.

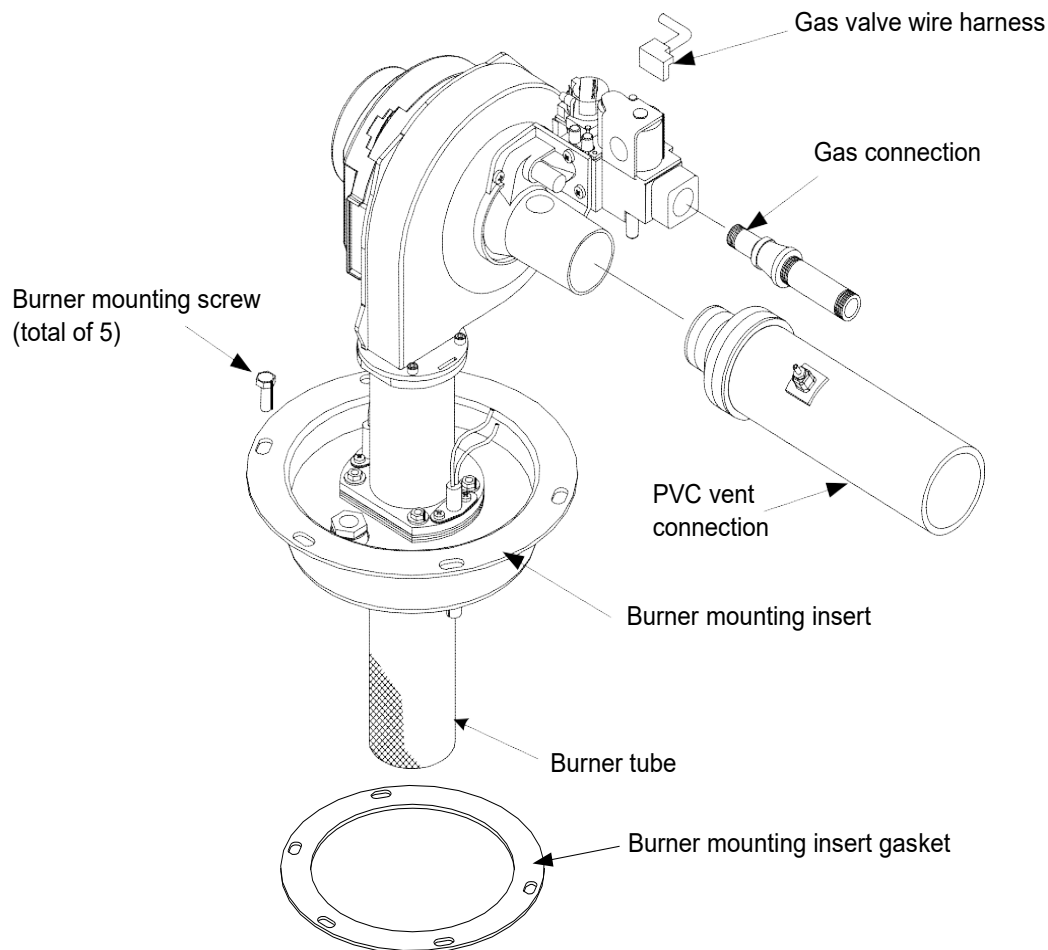

Service Procedure III

Burner Tube Inspection and Replacement

Burner Tube Removal Procedure

1. Position main power switch to OFF.
2. Disconnect (unplug) water heater from 120 volt power source.
3. Turn OFF gas supply to the water heater.
4. Unlatch and remove the surround cover from the top of the water heater.
5. From the gas valve, disconnect the gas connection, PVC venting, silicone tubing, and wire harness.
6. Disconnect the wire harness from the blower assembly.
7. Remove the two screws holding each the igniter and flame sensor in place (long reach magnetic Phillips screwdriver). Carefully remove igniter and flame sensor from combustion assembly.
8. Remove the 4 nuts (7/16" wrench) holding the burner transition in place. Lift the blower/gas valve transition assembly from burner mounting insert, remove gasket and set aside.
9. Remove burner tube from burner mounting insert. See next page for burner tube inspection procedure.

⚠ WARNING

120 volt potential exposure. Isolate the appliance and reconfirm power is disconnected using a multi-meter.

⚠ WARNING

Heater components may be HOT when performing the following steps in this procedure. Take necessary precaution to prevent personal injury.

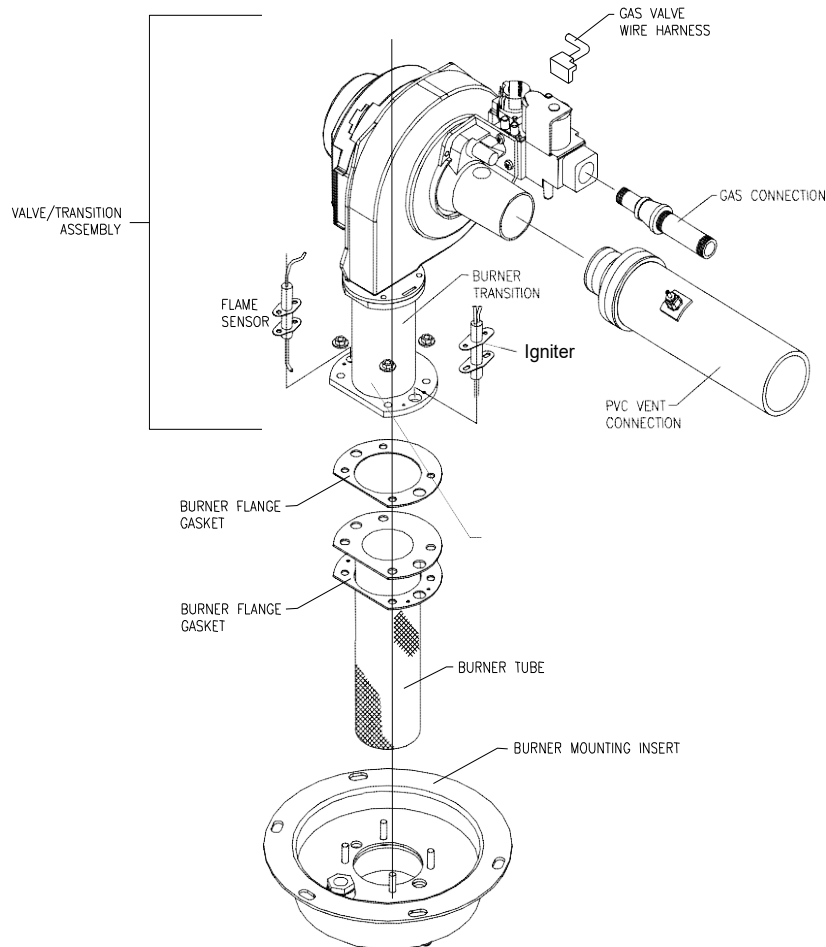

Service Procedure III

Burner Tube Inspection and Replacement (Continued)

Burner Tube Inspection

1. **Inspect burner tube as follows (ceramic fiber mesh burner, water heaters prior to serial number “CK”):**
 - a) Visually inspect ceramic fiber mesh; mesh should be uniform in appearance without large gaps, tears, or fraying. Mesh should have uniform pattern allowing for unrestricted gas flow.
 - b) Gently squeeze burner tube, Burner tube should feel firm without any soft areas around the sides or at the bottom.
 - c) Visually inspect inside burner tube, Burner tube should be intact with no areas of deterioration. Ports should be free of any debris.
2. **Inspect burner tube as follows (metal fiber mesh burner, water heaters with “CK” serial number or later):**
 - a) Outer fiber mesh should be uniform with no tears or deterioration.
3. If burner tube is affected by any of the above, replacement is required. Refer to burner tube replacement procedure below.

⚠ WARNING

Heater components may be HOT when performing the following steps in this procedure. Take necessary precaution to prevent personal injury.

Burner Tube Replacement Procedure

Note: New metal fiber mesh burner is the replacement burner for the ceramic fiber sock burner. The length of burner will **NOT** be the same as the previous ceramic burner. Provide the model and serial number for the correct replacement burner.

1. Fully inspect burner flange gaskets, igniter and flame sensor gaskets for the following:
 - a) Tears
 - b) Missing material
 - c) Cracks
 - d) Dirt or debris
 - e) Other imperfections that would inhibit proper sealIf gaskets are NOT affected by any of the above, gasket replacement is not required.
2. Install burner tube with gaskets into burner mounting insert. Be sure gasket surfaces are free of debris.
3. Reconnect the blower/gas valve/transition assembly to burner mounting insert. Secure using nuts from step 8 on previous page.
4. Carefully reinstall flame sensor with gasket and igniter with gasket and secure with screws from step 7 on previous page. Reconnect wire harnesses to sensor and igniter.
5. Reconnect wire harnesses to blower motor and to the gas valve.
6. Reconnect PVC venting, gas supply and silicone tubing to gas valve. Turn on gas to heater and check for gas leaks, repair any gas leaks found.
7. Restore 120 volt power supply to water heater and confirm proper operation following the lighting instructions on the lighting instruction label or the lighting instruction located in the Installation and Operating Instruction Manual.
8. Replace the surround cover on the top of the water heater.

Service Procedure IV

Gas Valve Replacement

Gas Valve Replacement Procedure

⚠ WARNING

120 volt potential exposure. Isolate the appliance and reconfirm power is disconnected using a multi-meter.

1. Position main power switch to OFF.
2. Disconnect (unplug) water heater from 120 volt power source.
3. Turn OFF gas supply to water heater.
4. Unlatch and remove the surround cover from the top of the water heater.
5. From the gas valve, disconnect the gas connection, PVC venting, wire harness, and silicone tubing.
6. Remove the two gas valve mounting screws (Torx bit) located on the venturi mounting flange and remove gas valve from water heater.
7. Remove any residual gasket material from blower and venturi mounting flange.
8. Install new gas valve with new gasket provided. Secure gas valve in place using screws from step 6.
9. Reconnect PVC venting, gas supply, silicone tubing, and wire harness to the gas valve. Turn ON gas supply to heater and check for gas leaks, repair any gas leaks found.
10. Restore 120 volt power supply to water heater and confirm proper operation following the lighting instructions on the lighting instruction label or the lighting instruction located in the Installation and Operating Instruction Manual.
11. Replace the surround cover on the top of the water heater.

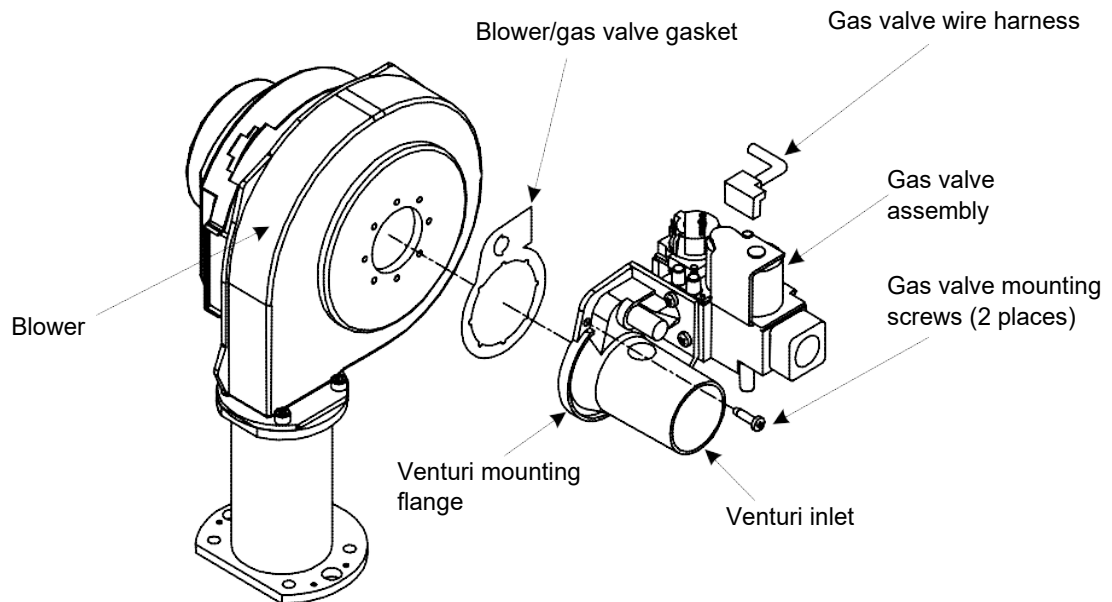

Service Procedure V

Blower Testing and Replacement

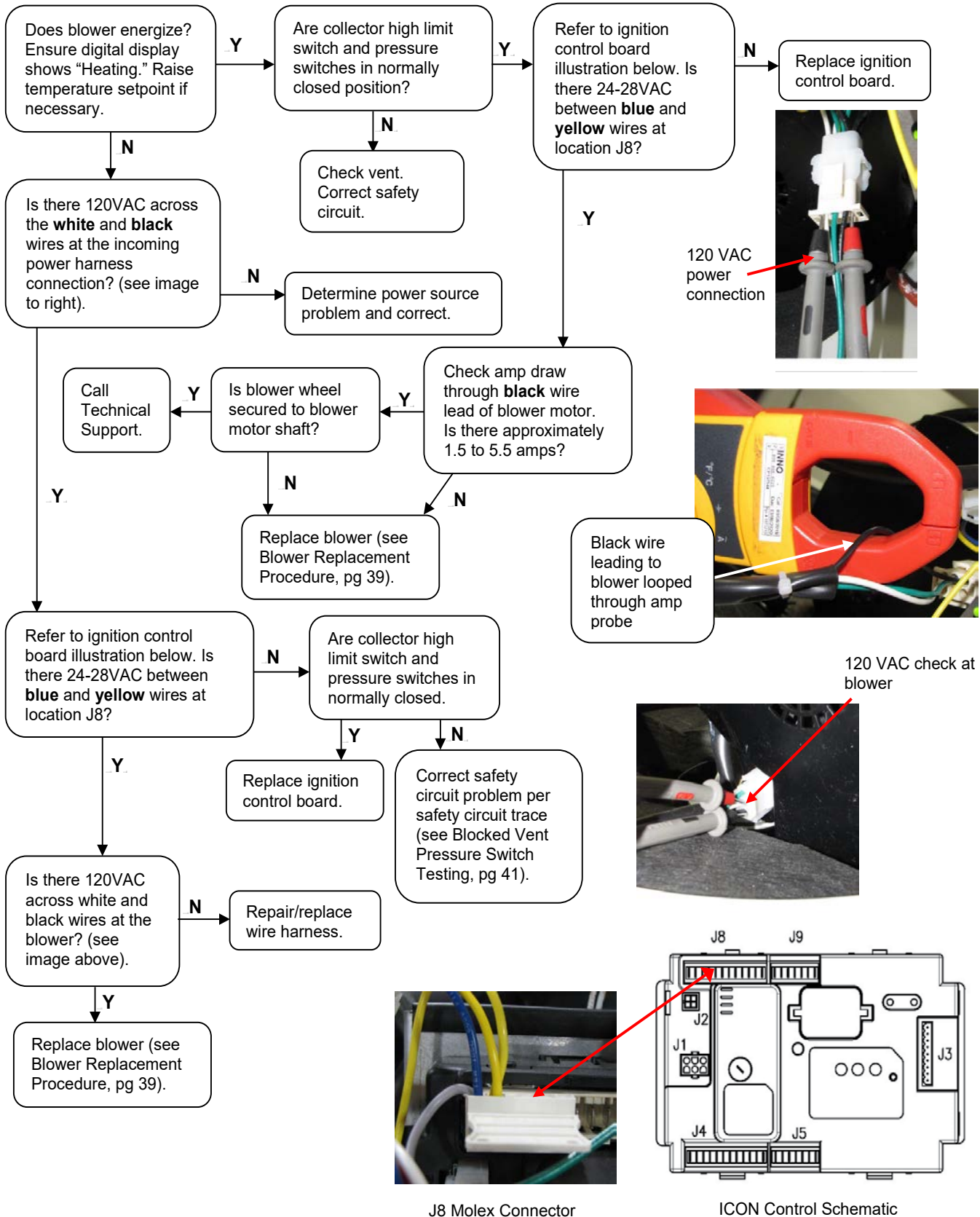

Service Procedure V

Blower Testing and Replacement (Continued)

Blower Replacement Procedure

⚠ WARNING

120 volt potential exposure. Isolate the appliance and reconfirm power is disconnected using a multi-meter.

1. Position main power switch to OFF.
2. Disconnect (unplug) water heater from 120 volt power source.
3. Turn OFF gas supply to water heater.
4. Unlatch and remove surround cover from top of heater.
5. Disconnect wire harness from blower.
6. Disconnect intake vent and gas supply from gas valve assembly.
7. Remove the two gas valve mounting screws (Torx bit) located on the venturi mounting flange.
8. Remove the four blower flange mounting screws (5/32 Allen wrench) and remove blower from transition flange.
9. Remove any residual gasket material from venturi mounting flange and transition flange.
10. Install new blower with new gasket provided. Secure blower in place using screws from step 8.
11. Reconnect gas valve assembly to blower with new gasket provided. Secure gas valve in place using screws from step 7.
11. Reconnect intake vent and gas line to gas valve assembly and check for gas leaks repair any leaks found.
13. Reconnect wire harness to blower assembly. Restore 120 volt power supply and gas supply to water heater and confirm proper operation following the lighting instructions on the lighting instruction label or the lighting instructions located in the Installation and Operating Instruction Manual.
14. Replace the surround cover on the top of the water heater.

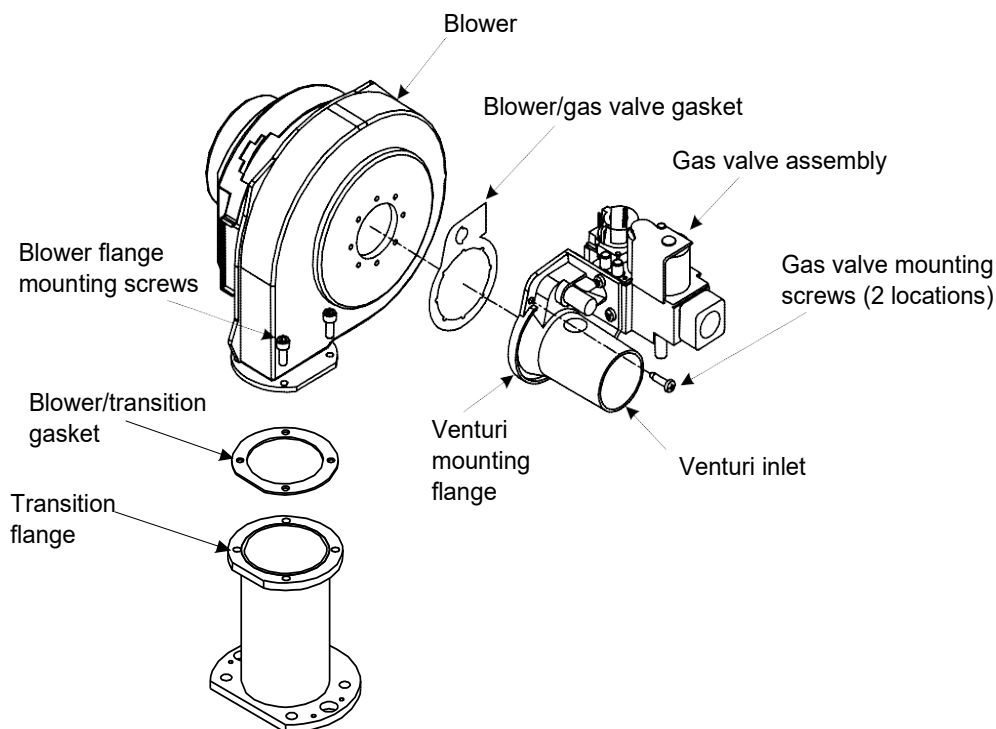

Service Procedure VI

Exhaust Pressure Switch Testing and Replacement

Exhaust Pressure Switch Replacement Procedure

1. Position main power switch to OFF.
2. Loosen adhesive backed rubber escutcheon from service panel access cover and slide escutcheon back along exhaust pipe to allow for removal of cover.
3. Remove screws from service panel access cover (1/4" nut driver) and remove cover from heater (see images at right).
4. Disconnect silicone tubing and wire leads from pressure switch (see images at right).
5. Remove pressure switch mounting screws (5/16" wrench) and remove the pressure switch.
6. Assemble new pressure switch to heater using screws from Step 5.
7. Reconnect wire leads. **Note:** Wire leads are interchangeable with either terminal.
8. Reconnect silicone tubing to pressure switch as follows:

- a. Exhaust pipe tubing connects to the pressure switch port.

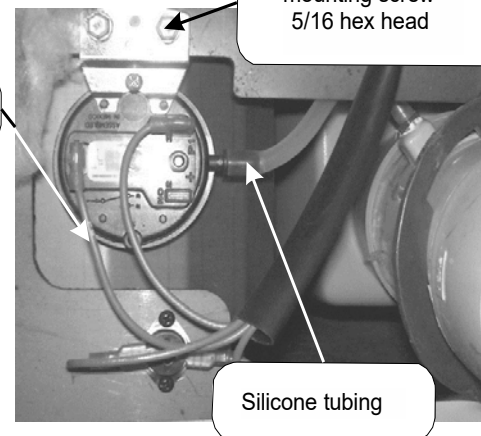
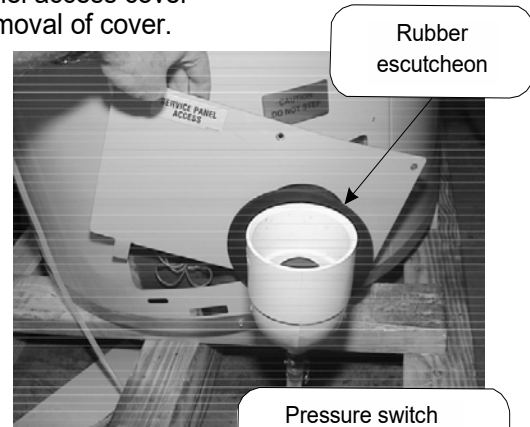
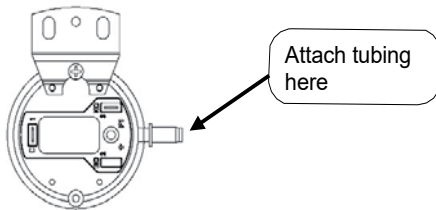

9. Restore 120 volt power supply to water heater and confirm proper operation following the lighting instructions on the lighting instruction label or the lighting instructions located in the Installation and Operating Instruction Manual.
10. Reinstall the service panel access cover and rubber escutcheon.

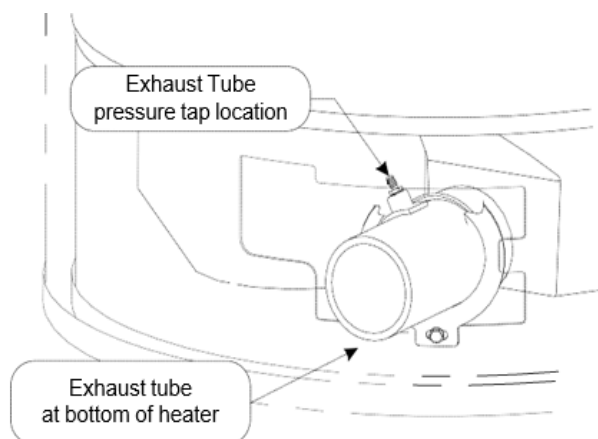

Service Procedure VI

Blocked Vent Pressure Switch Testing and Replacement (Continued)

⚠ WARNING

120 volt potential exposure. Use caution making voltage checks to avoid personal injury.

⚠ WARNING

Make sure exhaust collector compartment is not overheating (350°F) before resetting vent safety switch. If there is evidence the collector compartment is overheating, call Technical Support.

Sequence of Operation: The blocked vent pressure switch monitors the pressure in the exhaust tube. The switch contacts are normally closed and will not open unless there is a blockage in the exhaust venting or terminal (snow, ice, debris). If the blocked vent pressure switch contacts open after the thermostat initiates the blower, the blower will remain on for to 5 minutes waiting for the contacts to close. If the contacts remain open, the blower will stop, and error code 67 will appear on the display.

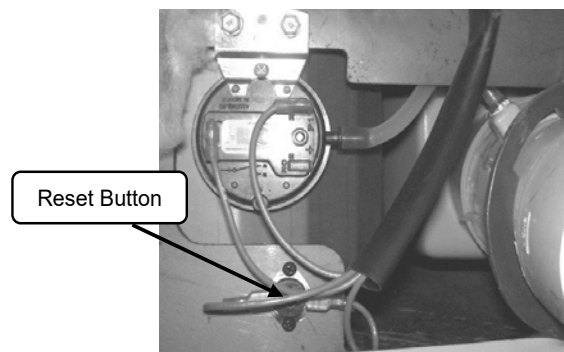
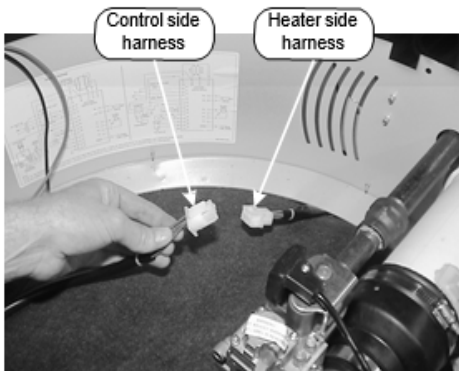
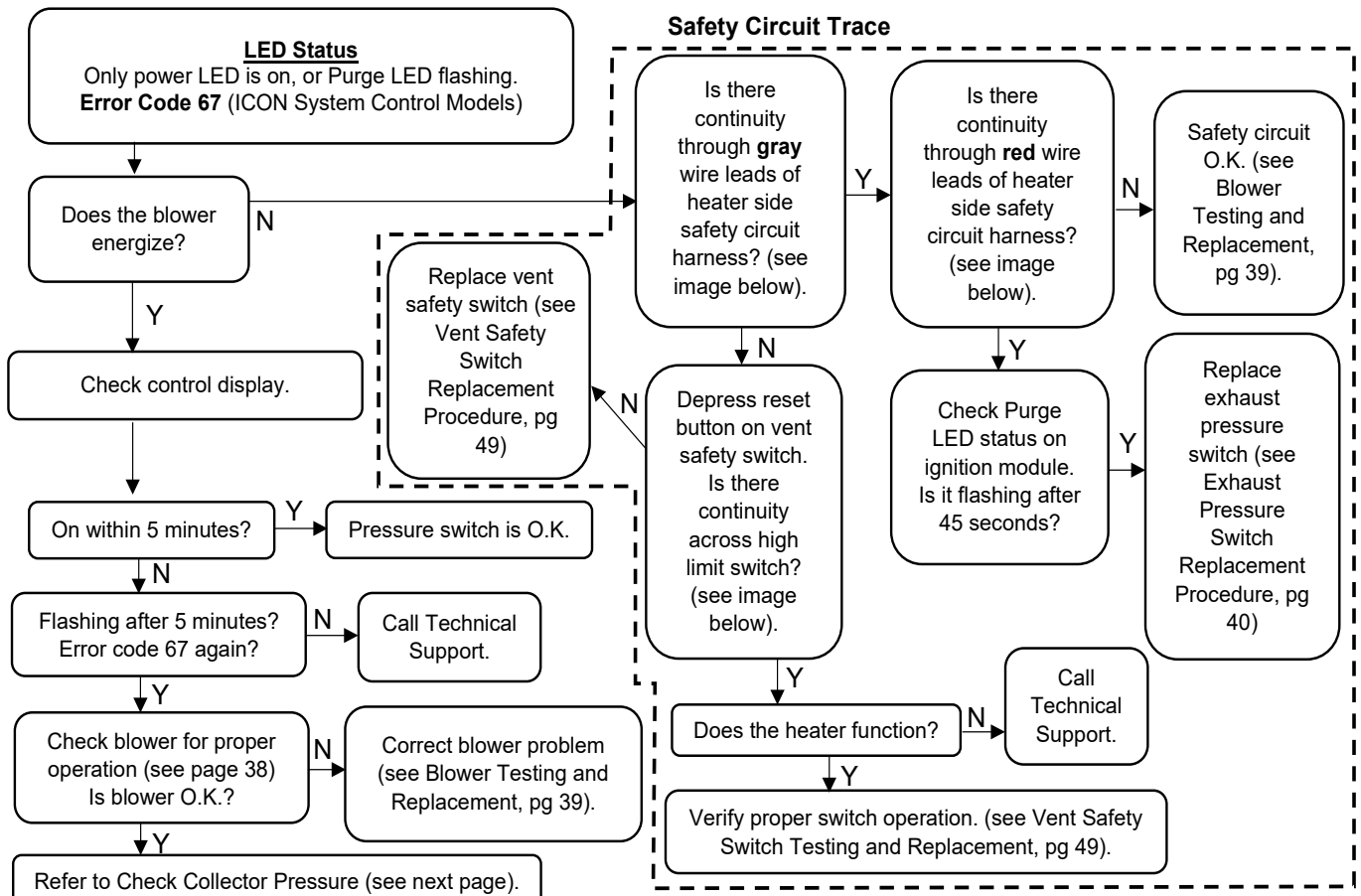

Service Procedure VI

Blocked Vent Pressure Switch Testing and Replacement (Continued)

Check Exhaust Tube Pressure

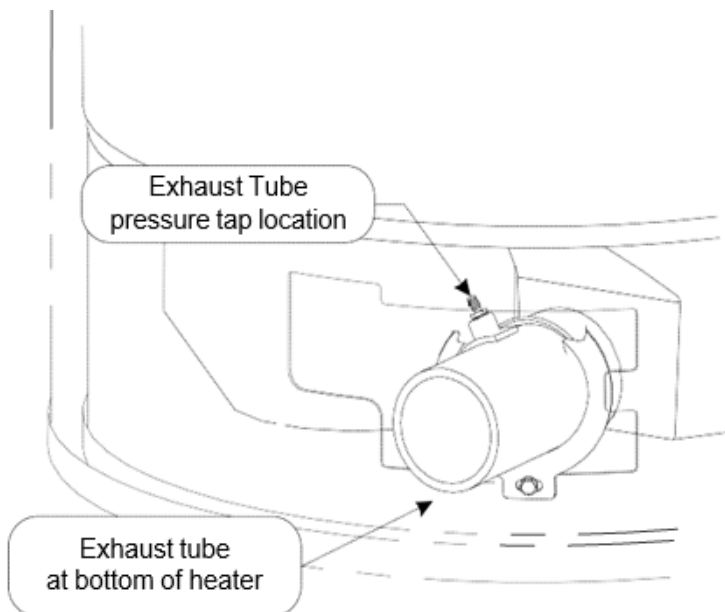
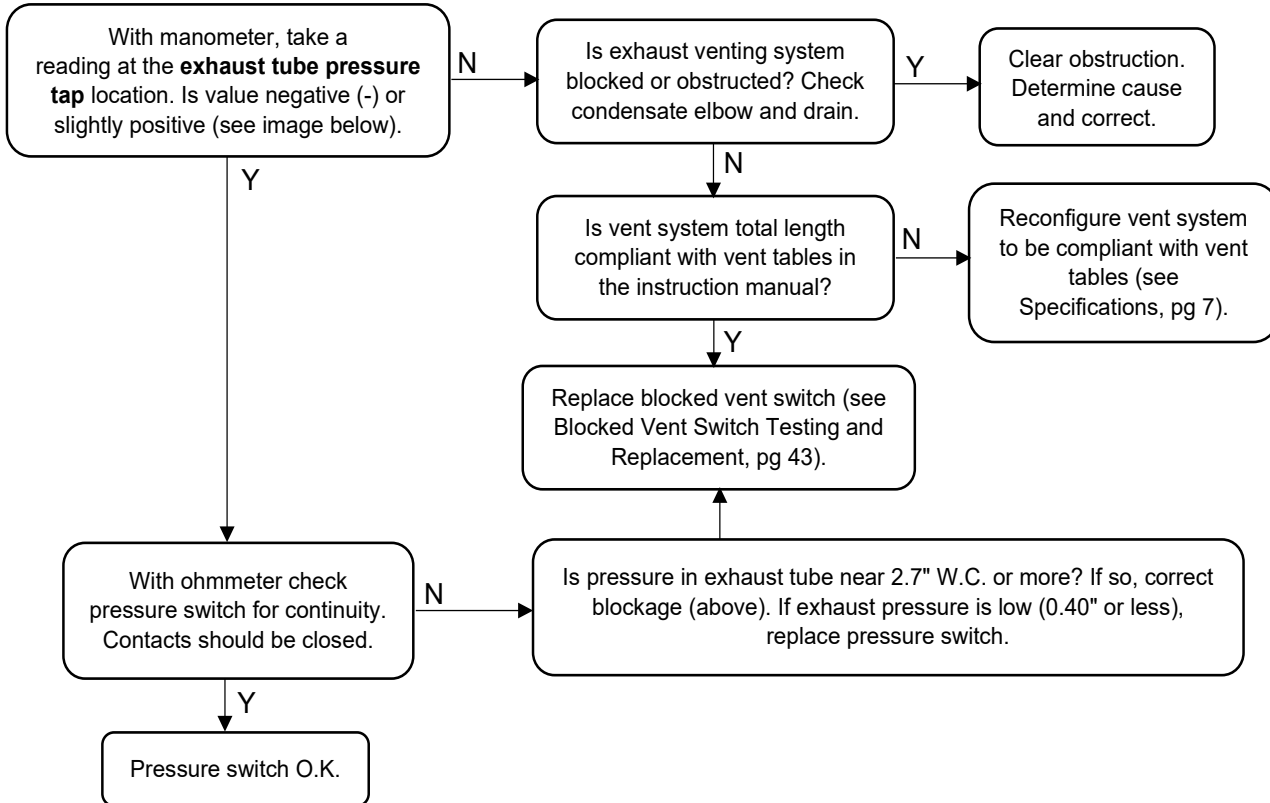

Service Procedure VI

Blocked Vent Pressure Switch Testing and Replacement (Continued)

Exhaust Pressure Switch Replacement Procedure

1. Position main power switch to "OFF" position.
2. Loosen adhesive backed rubber escutcheon from service panel access cover and slide escutcheon back along exhaust pipe to allow for removal of cover.
3. Remove screws from service panel access cover ($\frac{1}{4}$ " nut driver) and remove cover from heater (see images at right).
4. Disconnect silicone tubing and wire leads from pressure switch (see images at right).
5. Remove pressure switch mounting screws ($\frac{5}{16}$ " wrench) and remove pressure switch.
6. Assemble new pressure switch to heater using screws from Step 5.
7. Reconnect wire leads. **Note:** Wire leads are interchangeable with either terminal.
8. Reconnect silicone tubing to pressure switch as follows:
 - a. Exhaust pipe tubing connects to single tap located on switch.
9. Restore 120 volt power supply to water heater and confirm proper operation following the lighting instructions on the lighting instruction label or the lighting instructions located in the Installation and Operating Instruction Manual.
10. Reinstall service panel access cover and rubber escutcheon.

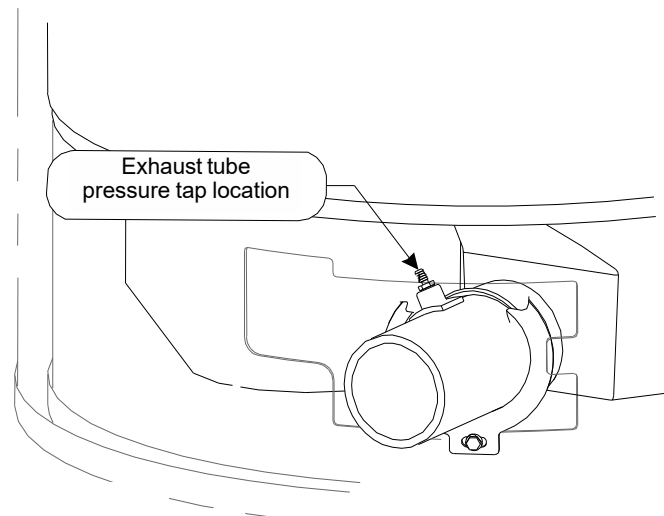
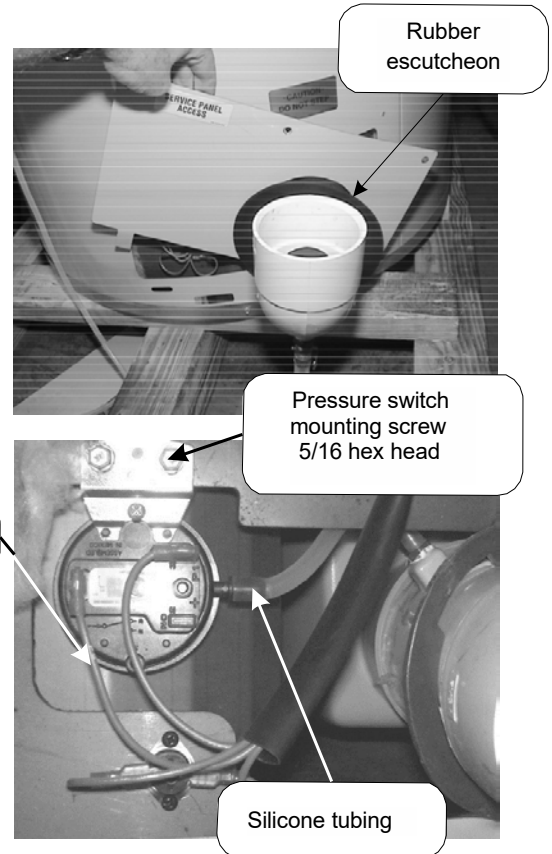

Service Procedure VII

Flame Sensor Testing and Replacement

Flame Sensor Testing Procedure

⚠ WARNING
 120 volt potential exposure. Use caution making voltage checks to avoid personal injury. Flame sensor may be too hot to handle, take necessary precautions.

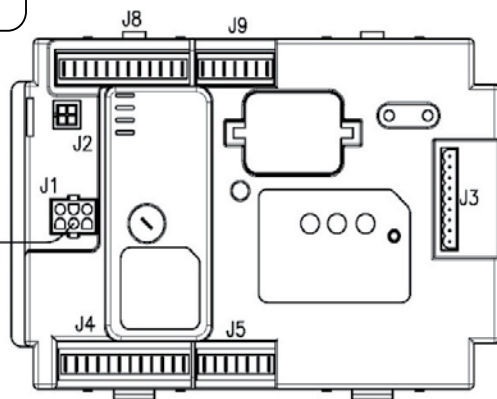
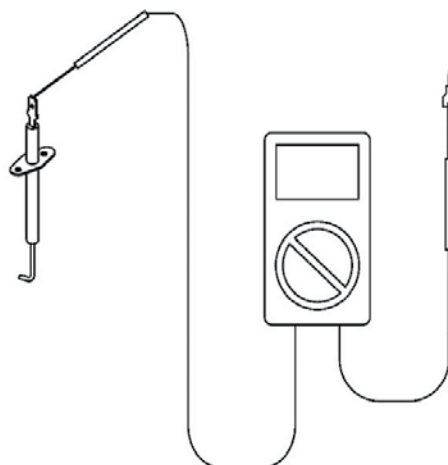
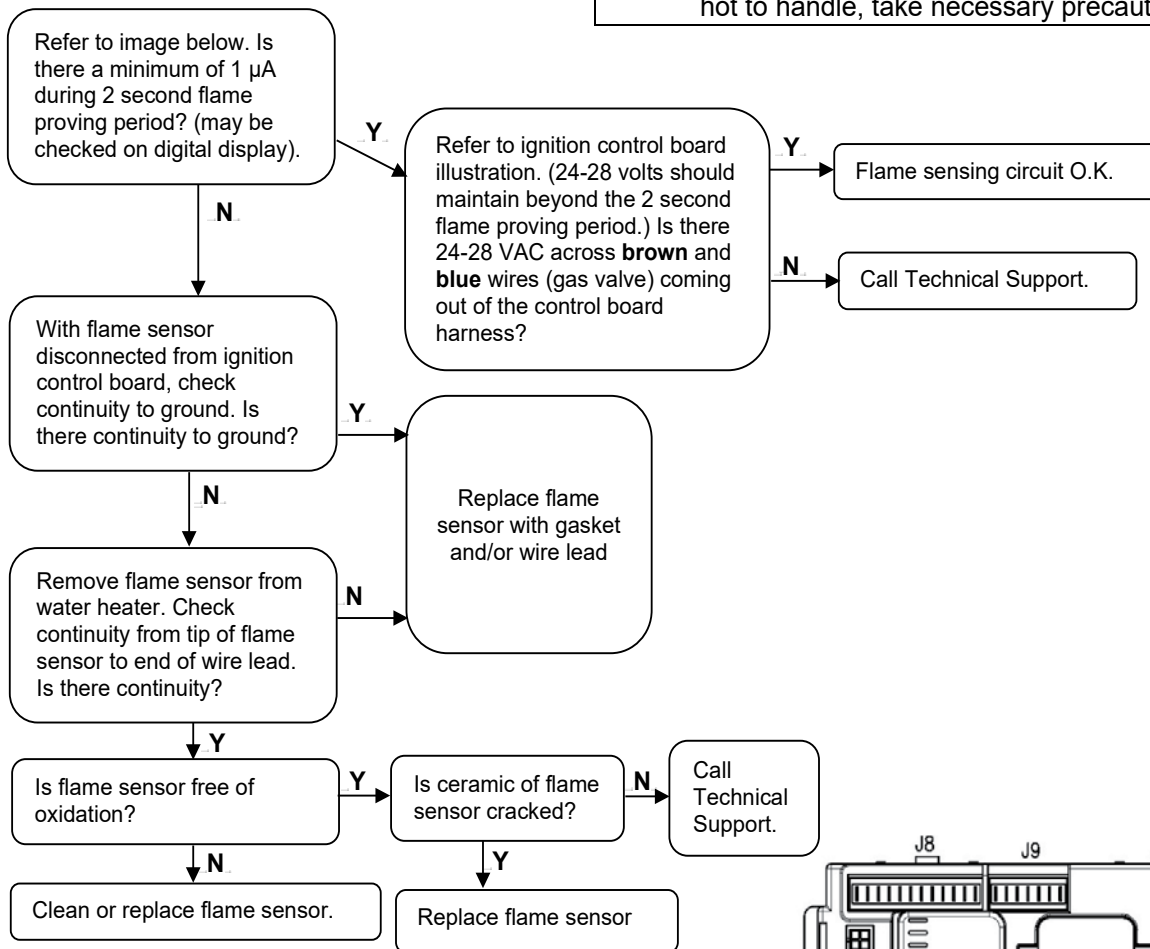

ICON Control Board Schematic

Service Procedure VIII

Spark Rod Gap Adjustment and Replacement

Spark Rod Gap Inspection and Adjustment

1. Remove combustion system as described in Combustion System Removal Procedure (pg 33).
2. Measure spark gap between the spark rod and burner tube. Acceptable spark gap is between 3/16"-1/4" (see images below).
3. If spark gap is not between 3/16" - 1/4", the spark rod may be carefully bent by supporting the end near the ceramic insulator with pliers and bending the end near the burner tube with needle nose pliers (see image below).
4. Ensure and verify spark gap is between 3/16"-1/4" after bending.
5. Reinstall the combustion system per Combustion System Replacement Procedure (pg 33) and check several ignitions to ensure the burner lights smoothly.

⚠ WARNING

Spark gap must be set to 3/16" to 1/4". Failure to set and verify proper spark gap may result in a delayed ignition resulting in damage to the water heater.

⚠ CAUTION

Use caution while performing these steps to prevent stressing or cracking the ceramic insulator.

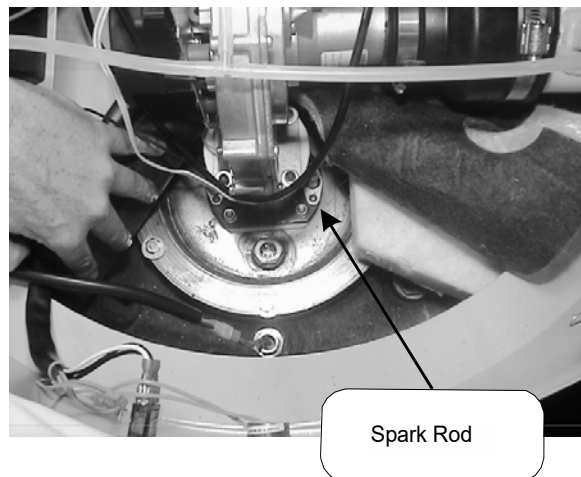
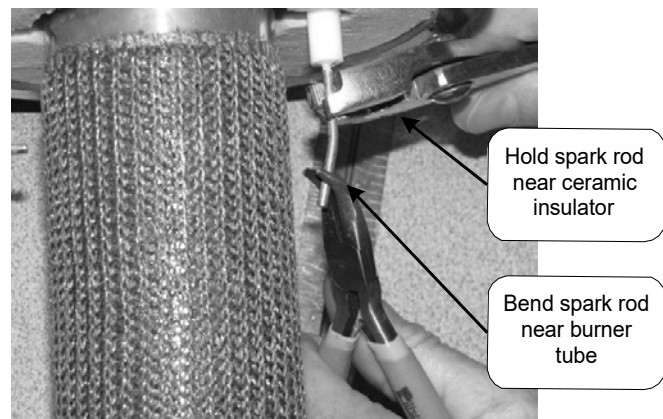
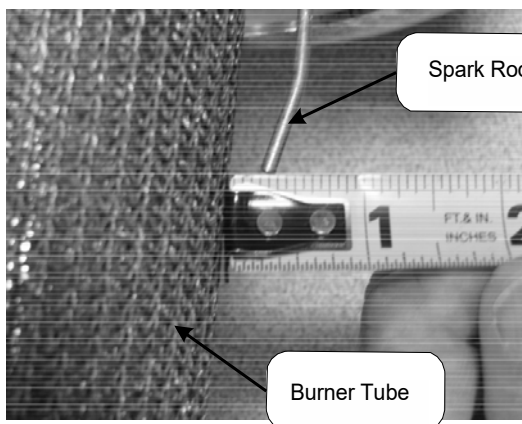

Service Procedure VIII

Spark Rod Gap Adjustment and Replacement (Continued)

Spark Rod Replacement Procedure

1. Position main power switch to OFF.
2. Disconnect (unplug) water heater from 120-volt power source.
3. Unlatch and remove the surround cover from the top of the water heater.
4. Fold back insulation in front of combustion assembly to expose spark rod (see image at right).
5. Disconnect the wire lead from the spark rod.
6. Remove the 2 mounting screws (magnetic tip, long reach Phillips screwdriver) and remove spark rod and gasket from the transition base flange.
7. Remove any residual gasket material from transition base flange.
8. Install new spark rod with new gasket provided using screws from step 6. Arrange spark rod with hook towards burner (off-center mounting hole towards the front of the water heater).
9. Remove combustion system following Combustion System Removal Procedure (pg 33) and verify spark gap following Spark Rod Gap Adjustment and Replacement (pg 45).
10. Reassemble combustion system following Combustion System Replacement Procedure (pg 33).
11. Fold insulation back into place. Be sure no wires are in contact with burner flange.
12. Restore 120-volt power supply to water heater and confirm proper operation following the lighting instructions on the lighting instruction label or the lighting instructions located in the Installation and Operating Instruction Manual.
13. Replace the surround cover on the top of the water heater.

⚠ WARNING

120-volt potential exposure. Isolate the appliance and reconfirm power is disconnected using a multimeter.

⚠ CAUTION

If spark rod is replaced for any reason, the combustion system MUST be removed and the spark gap to the burner measured and adjusted properly.

⚠ WARNING

Spark gap must be set to 3/16" to 1/4". Failure to set and verify proper spark gap may result in a delayed ignition resulting in damage to the water heater.

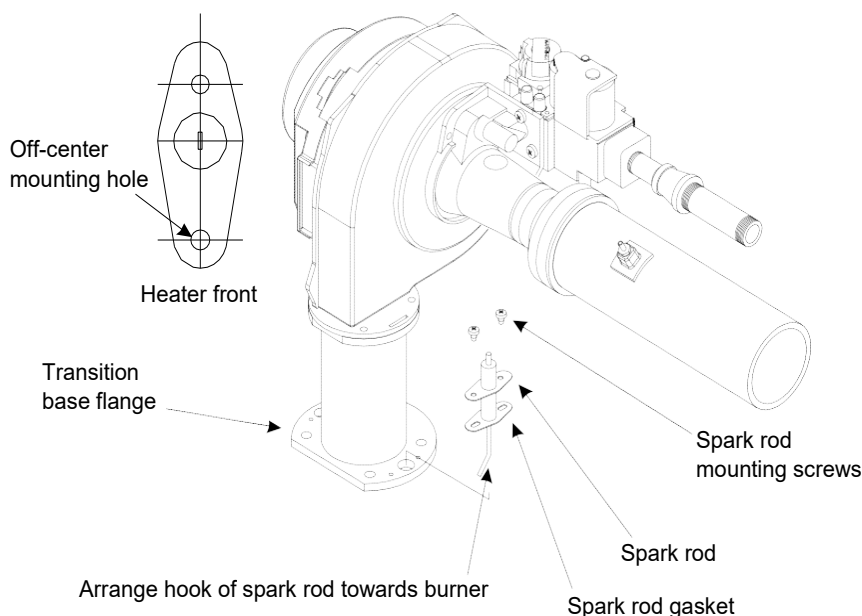
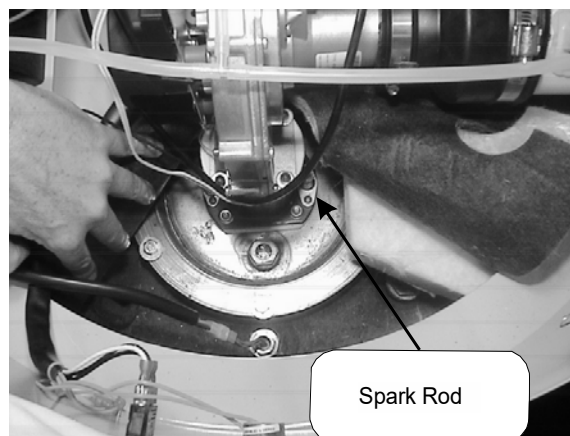

Service Procedure IX

Ignition Module/Control Board Replacement

Control Board Replacement

1. Position main power switch to OFF.
2. Disconnect (unplug) water heater from 120-volt power source.
3. Unlatch and remove top surround cover from top of water heater.
4. Locate the control board.
5. Carefully disconnect all wire connections from the control board.
Note: It may be necessary to identify wires for proper re-connection.
6. Depress the plastic tabs on the top back side of the control board first.
7. Tilt the control board and slide control board hook tabs from slots in the metal panel (see images below).
8. Replace the control board and all wire connections.
9. Restore 120-volt power supply to water heater and confirm proper operation following the lighting instructions on the lighting instruction label, or the lighting instructions located in the Installation and Operating Manual.
10. Replace surround cover on the top of the water heater.

⚠ WARNING

120-volt potential exposure. Isolate the appliance and reconfirm power is disconnected using a multimeter.

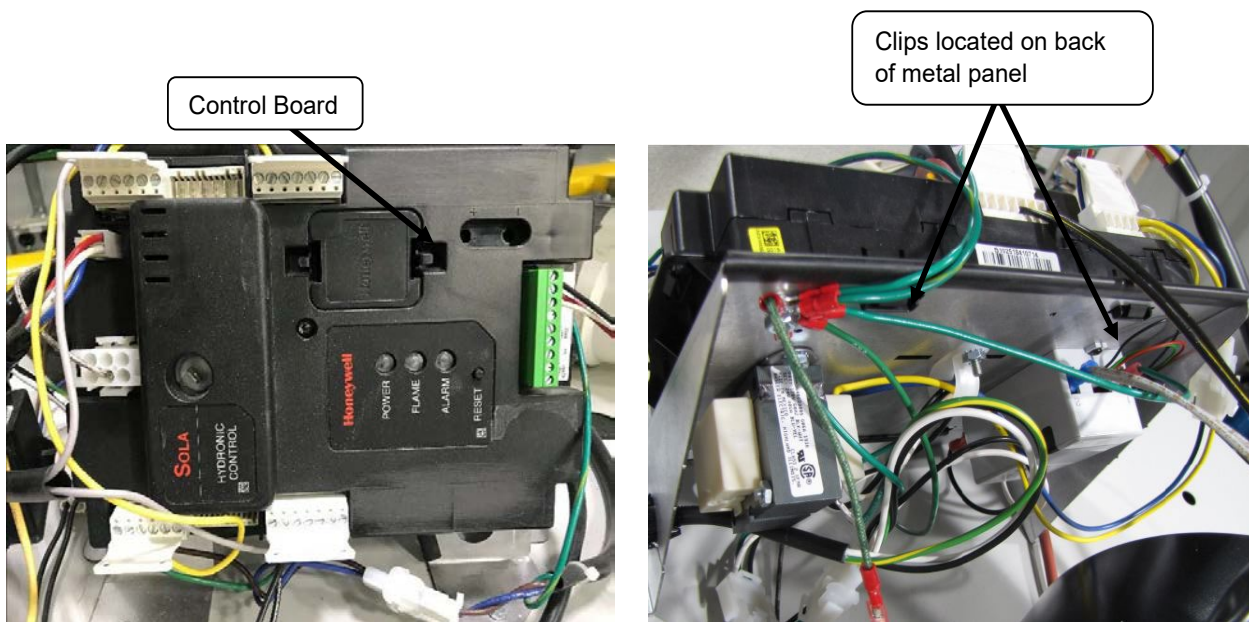

Service Procedure X

Transformer Replacement

Transformer Replacement Procedure

1. Position main power switch to OFF.
2. Disconnect (unplug) water heater from 120-volt power source.
3. Unlatch and remove surround cover from top of water heater.
4. Disconnect primary leads (**black** and **white**) and secondary leads (**blue** and **yellow**) from the transformer (connections are different sizes to prevent interchanging).
5. Remove the 2 nuts (7/16" nut driver) holding the transformer in place and remove transformer from control board (see image below).
6. Install new transformer and secure in place with screws from step 5.
7. Reconnect primary and secondary wires to the transformer (leads are different sizes to prevent interchanging).
8. Restore 120-volt power supply to water heater and confirm proper operation following the lighting instructions on the lighting instruction label, or the lighting instructions located in the Installation and Operating Manual.
9. Replace the surround cover on the top of the water heater.

⚠ WARNING

120-volt potential exposure. Isolate the appliance and reconfirm power is disconnected using a multimeter.

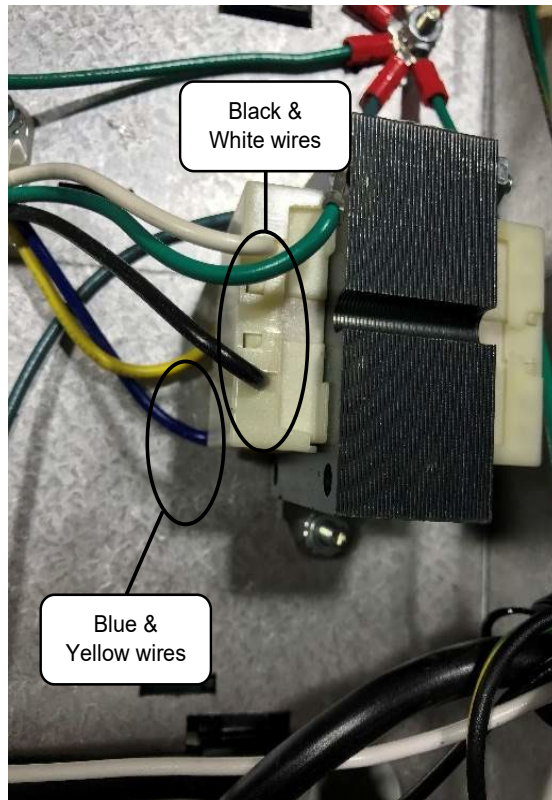

Service Procedure XI

Vent Safety Switch Testing and Replacement

⚠ WARNING

120 volt potential exposure. Isolate the appliance and reconfirm power is disconnected using a multimeter.

⚠ WARNING

Make sure the exhaust collector compartment is not overheating (350°F) before resetting vent safety switch. If there is evidence the collector compartment is overheating, call Technical Support.

Sequence of Operation

Error code 67 will display indicating an open circuit for the vent safety switch. Determine if temperature has reached 350°F before resetting switch and restoring operation. If evidence of extreme temperature is present, call Technical Support.

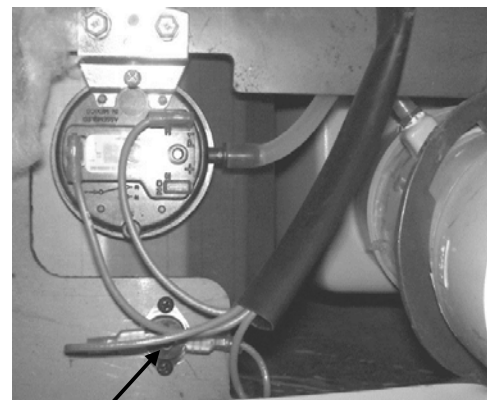
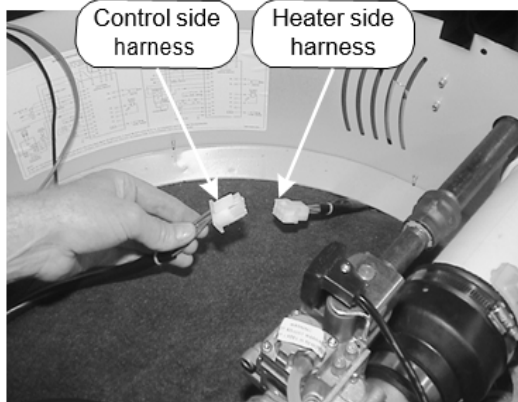
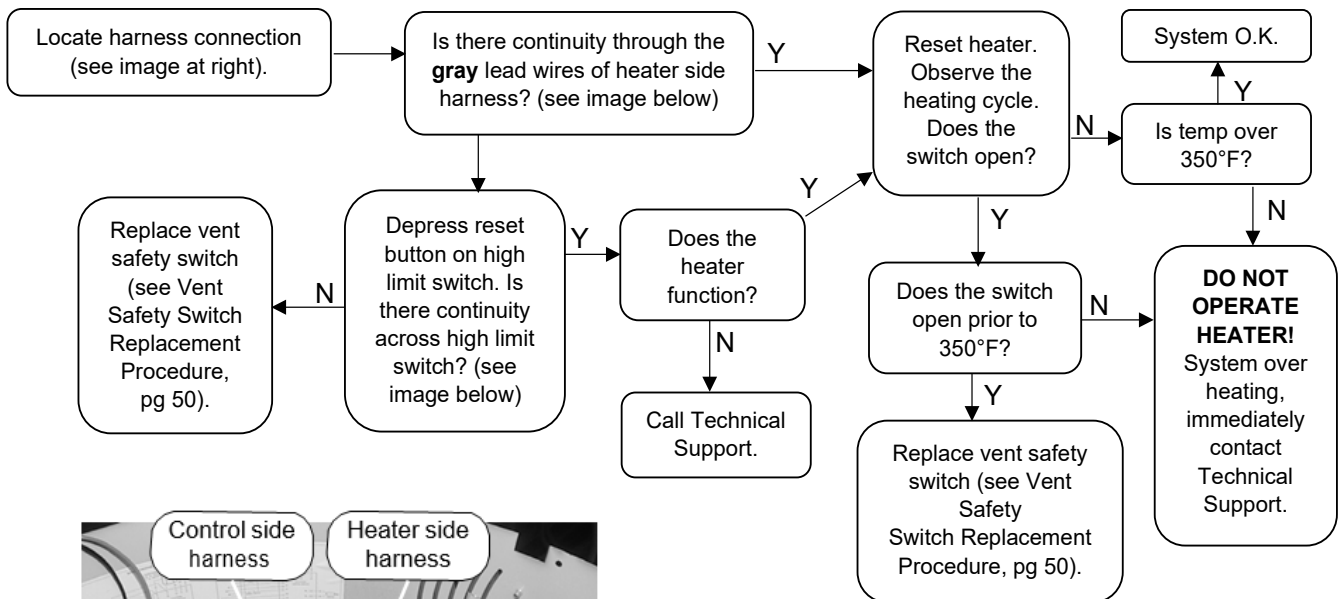

Reset Button

Service Procedure XI

Vent Safety Switch Testing and Replacement (Continued)

Vent Safety Switch Replacement Procedure

⚠ WARNING

120 volt potential exposure. Isolate the appliance and reconfirm power is disconnected using a multimeter.

1. Position main power switch to OFF.
2. Loosen the adhesive backed rubber escutcheon from the service panel access cover and slide the escutcheon back along the exhaust pipe to allow for removal of cover (see photos below).
3. Remove the screws from service panel access cover ($\frac{1}{4}$ " nut driver) and remove the cover from the water heater (see images below)
4. Disconnect the wire leads from the vent safety switch (see image below).
5. Remove the 2 switch mounting screws (Phillips screwdriver) and nuts ($\frac{5}{16}$ wrench) and remove the switch from the water heater.
6. Install new switch using the screws from step 5.
7. Reconnect the wire leads.
Note: Wire leads are interchangeable with either switch terminal.
8. Restore 120 volt power supply to water heater and confirm proper operation following the lighting instructions on the lighting instruction label or the lighting instruction located in the Installation and Operating Instruction Manual.
9. Reinstall the service panel access cover and the rubber escutcheon.

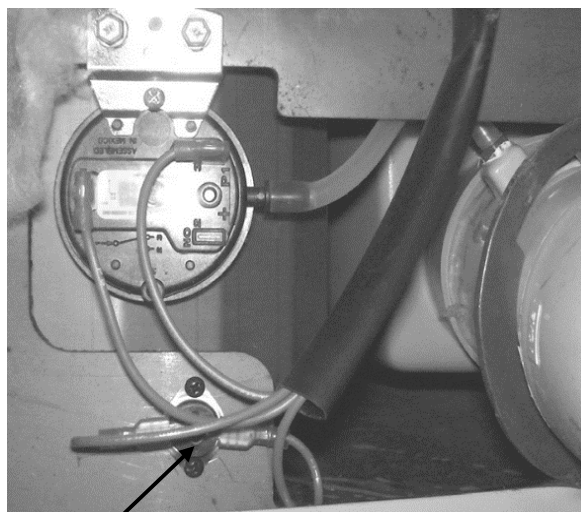

Service Procedure XII

Flue Baffle Inspection and Replacement

⚠ WARNING

Heater components may be HOT when performing the following steps in this procedure. Take necessary precaution to prevent personal injury.

Flue Baffle Inspection and Replacement

1. Disassemble heater per Disassembly Procedure for Access to Anodes and Flue Baffles.
2. Remove flue baffles from heater using pliers (8 two inch (2") baffles & 2 four inch (4") baffles).
3. Visually inspect flue baffles. Flue baffles should show signs of oxidation, this is normal. If the oxidation has deteriorated any portion of the flue baffle, replacement is recommended. If any restrictors are missing, replacement is recommended.
4. Upon completion of inspection or subsequent replacement, reinstall flue baffles into heater.
5. Reinstall collector cover per Collector Cover Installation Procedure.
6. Reinstall collector insulation and control panel, reconnect control panel wire harnesses.
7. Restore 120 volts to water heater and verify proper heater operation following the instructions on the lighting instruction label or the lighting instruction located in the Installation and Operating Instruction Manual.
8. Replace the surround cover on the top of the water heater.

Collector Cover Installation Procedure

1. Remove old silicone from top surface of collector flange and collector cover.
2. Apply ¼" bead of Ultra Copper Silicone around entire collector flange surface. Allow caulk to "cure" for 10 minutes.
3. Carefully reinstall collector cover, tighten screws evenly.
4. Allow a minimum of 6 hours before putting heater back in service.

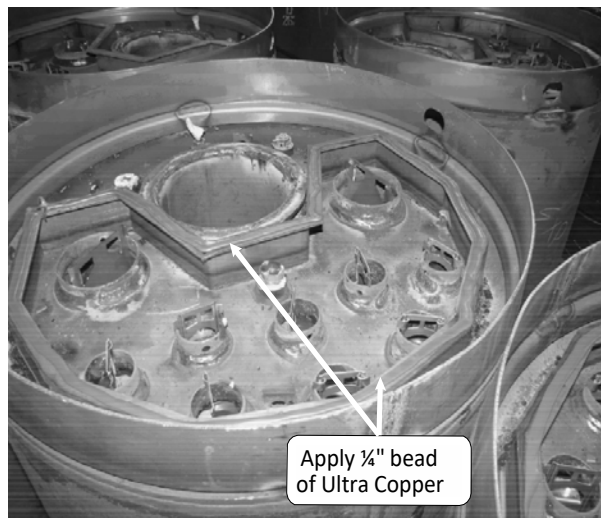

Service Procedure XIII

Procedure for Access to Magnesium Anodes & Flue Baffles

⚠ WARNING

Heater components may be **HOT** when performing the following steps in this procedure.

⚠ WARNING

120 volt potential exposure. Isolate the appliance and reconfirm power is disconnected using a multi-meter.

- Step 1. Position main power switch to "OFF".
- Step 2. Disconnect (Unplug) water heater from 120 Volt power source.
- Step 3. Un-latch & remove surround cover from top of heater.
- Step 4. Disconnect wire harnesses to allow for removal of control panel.
Note: Where ever possible, rather than disconnecting at the control panel, follow wire harness away from control panel and disconnect at control component location.
- Step 5. Remove the three control panel mounting screws (1/4" nut driver) and remove control panel from the water heater (see photos below).



- Step 6. Completely remove insulation (two pieces) from top of heater to expose collector cover

- Step 7. Remove all collector cover screws (5/16" socket) and remove collector cover (see photos at right).

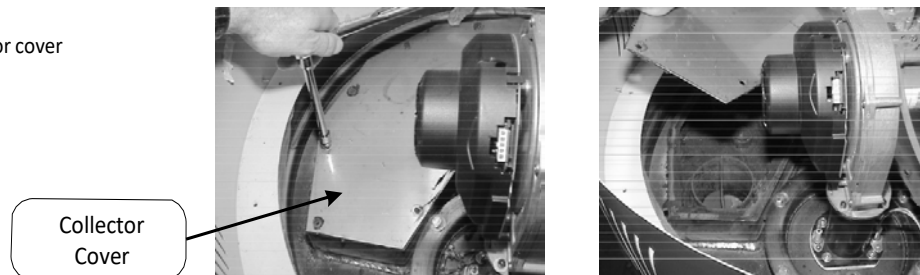

- Step 8. Photo 44 shows heater with collector cover removed allowing access to anode rods and flue baffles.
- a) for anode service, see "Anode Inspection and Replacement"
- b) for flue baffle service, see "Flue Baffle Inspection and Replacement"
- c) for powered anode service, see "Powered Anode Replacement"

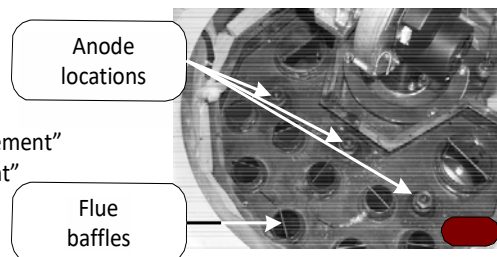

Service Procedure XIV

Magnesium Anode Inspection and Replacement

Heater components and stored water may be HOT when performing the following steps in this procedure. Take necessary precaution to prevent personal injury.

Step 1. Turn off water supply and drain water heater.

Step 2. Disassemble water heater per “Disassembly Procedure for Access to Anodes & Flue Baffles”.

Step 3. Locate and remove anode rods from heater (1-1/16 hex socket).

Step 4. Visually inspect anode rod. Anode rod should show signs of depletion, this is normal. If the depletion is ½ of the original diameter (approximately ¾" diameter), replacement is recommended. If any of the steel core of the anode is exposed, replacement is recommended.

Step 5. Upon completion of inspection or subsequent replacement, apply thread sealing tape or other thread compound to threads of anode and reinstall into heater. Restore water supply and check for and repair any leaks found.

Step 6. Reinstall collector cover per “Collector Cover Installation Procedure”.

Step 7. Reinstall collector insulation and control panel, reconnect control panel wire harnesses.

Step 8. Restore 120 volts to water heater and verify proper heater operation following the instructions on the lighting instruction label or the lighting instruction located in the installation and operating instruction manual.

Step 9. Replace surround cover on top of water heater.

Service Procedure XV

Powered Anode Replacement (If Applicable)

⚠ WARNING!

Water heater components may be HOT when performing the following steps in this procedure. Take necessary precaution to prevent personal injury.

The powered anode control module is located on the vertical side of the control panel inside the surround panel. The control has a LED indicator light to show the status of operation. When the tank is filled with water and the power supply is on the water heater, the light should have a steady green glow to indicate that protection current is flowing and operating normally. If the indicator light is not glowing, the power supply to the water heater or powered anode system is disconnected.

1. Check the power supply or wire connections to the powered anode control.
2. Indicator light diagnostic codes:
 - a. If the control is flashing red, then there is a malfunction with the powered anode system. Make sure there are no bare spots in the wire insulation to the powered anode rods.
3. Check all electrical connections. The powered anode rods are insulated from the water heater tank in the bushing.
 - a. With an ohmmeter, check continuity between the powered anode terminal and the bushing. There should not be continuity. If there is continuity, replace the powered anode assembly.

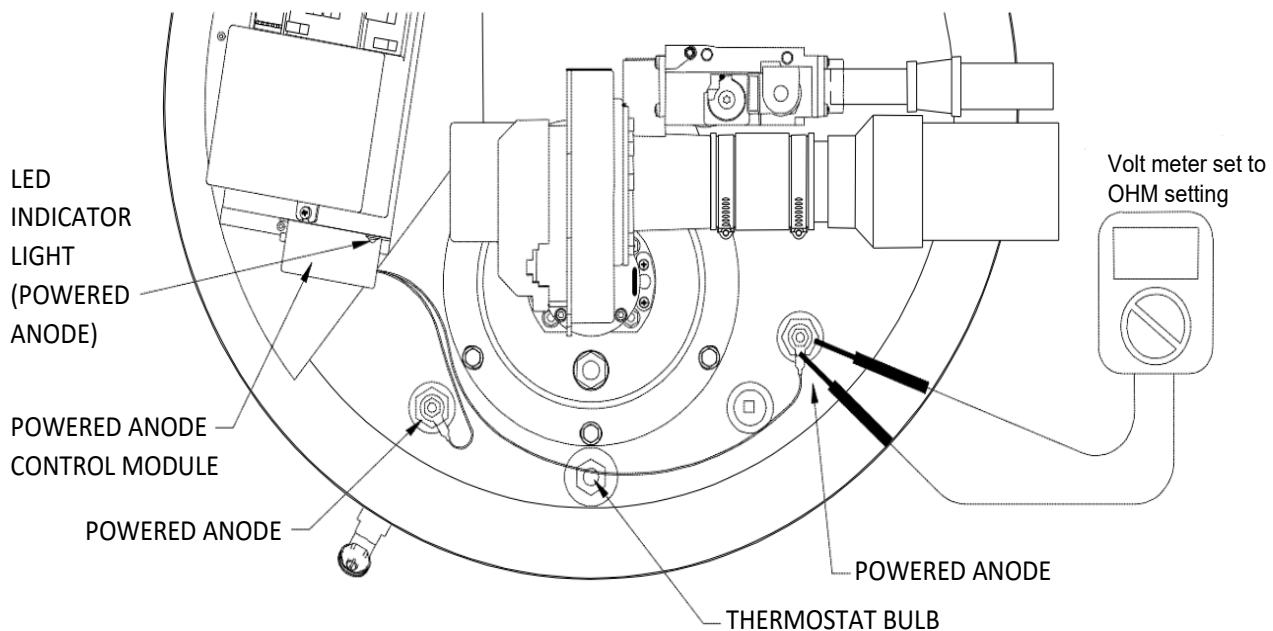

Section 2: Serial Numbers "XL-" (Nov. 2021) and Later with -895 Designator Specifications

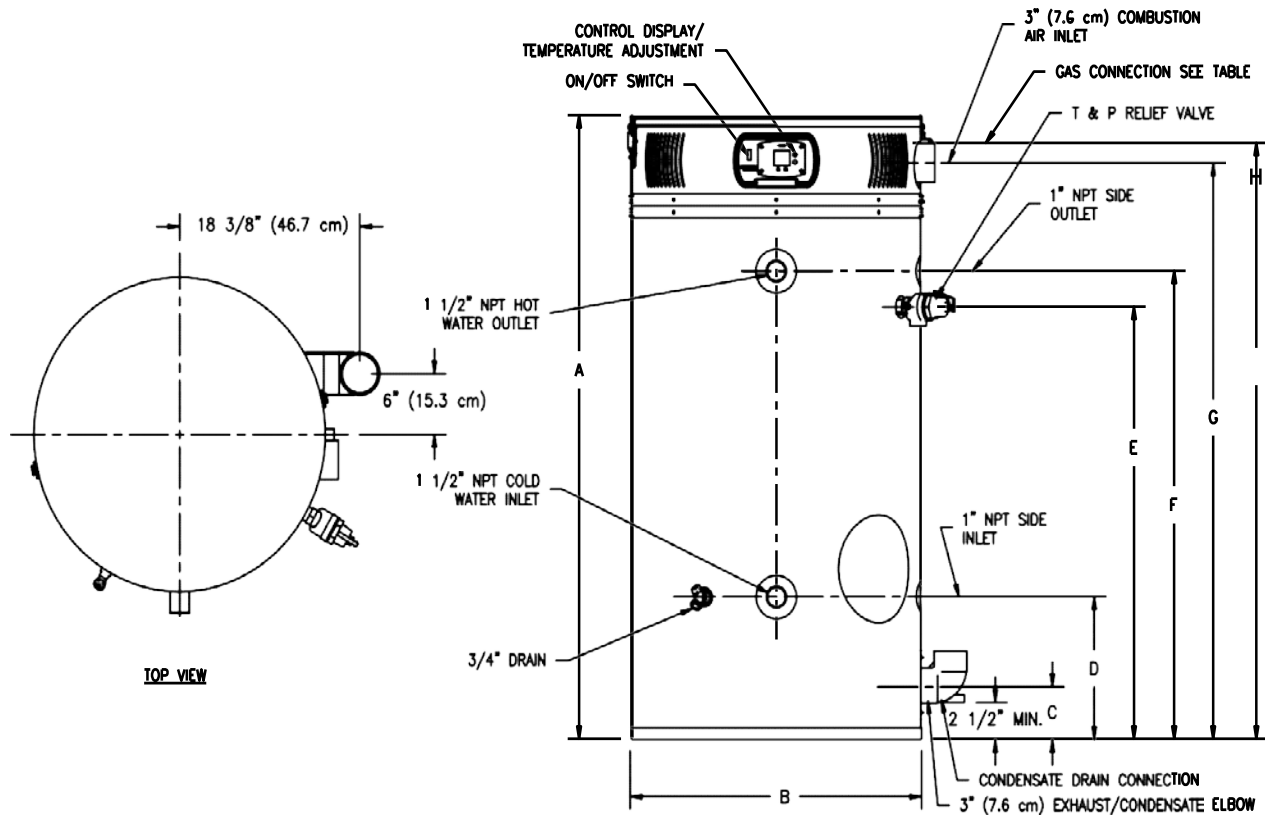

Model No.	Input Rate BTU/hr	1 st Hr. Del Gal @ 100 °F Rise	Recovery GPH at Degree Rise			Stg. Capacity US Gal	Therm. Efficiency %
			40°F	100°F	140°F		
60T125	125,000	187	363.6	145.5	103.9	60	96.0
60T150	150,000	211	422.7	169.1	120.8	60	93.0
60T199	199,999	265	557.6	223	158	60	92.0
100T150	150,000	250	450.5	180.2	129	100	97.0
100T199	199,999	309	597	238.8	171	100	97.0

DIMENSIONS (INCHES)													
Model No.	A Height	B Dia.	C Floor to Vent Outlet	D Floor to Inlet Water Conn.	E Floor to T&P Valve Conn	F Floor to Outlet Water Conn	G Floor to Air Intake	H Floor to Gas Conn	Front Water Conn Dia	Space Heating Conn Dia	Gas Conn Dia (NPT)	T&P Valve Open (NPT)	Shipping Weight (lbs)
60T125	57	28 ¼	5	13	40	42 ¼	52 ½	53 ½	1 ½	1	¾	¾	570
60T150	57	28 ¼	5	13	40	42 ¼	52 ½	53 ½	1 ½	1	¾	¾	570
60T199	57	28 ¼	5	13	40	42 ¼	52 ½	53 ½	1 ½	1	¾	¾	570
100T150	77 5/8	28 ¼	5	13	60	62 ¼	73 1/8	74 ¾	1 ½	1	¾	¾	900
100T199	77 5/8	28 ¼	5	13	60	62 ¼	73 1/8	74 ¾	1 ½	1	¾	¾	900

Integrated Control System

Serial numbers XL- (November 2021) and after with -895 designator

Features of Integrated Control System

- Attractive digital water heater display on control panel for setting and displaying the temperature setpoint. Pressing temperature UP and DOWN buttons changes the temperature setpoint. The same water heater display is used on all models. Temperature setpoint may be displayed in °F or °C.
- Single control board with plug in wiring controls temperature, ignition, and blower operation.
- Reduced number of parts for servicing and wiring.
- Burner ignition with direct spark ignition – A high voltage spark jumps from the spark rod to the burner surface to ignite the gas. Eliminates burned out igniter replacements.
- Water heater display will show diagnostic codes in the event the water heater needs servicing. Aids in diagnosing and servicing the water heater.
- The display can show previous error code history to further aid in servicing the water heater.

Power Supply	Dedicated 120 VAC, 60 Hz, 15A
Gas Supply	Minimum ¾" NPT (schedule 40 black iron pipe recommended)
Approved Gas Type	Natural or Propane. Unit must match gas type supplied.
Gas Pressure (Nat & L.P.)	Natural: 14" W.C. maximum static, 4.5" W.C. minimum running (recommended 7" W.C. min running) L.P. (Propane): 14" W.C. maximum static, 8" W.C. minimum running (recommended 11" W.C. min running)
Venting System	Power vent, balanced direct vent or unbalanced direct vent. See vent tables on page 9.
Approved Vent Materials	PVC, CPVC, Polypropylene, or Stainless Steel
Minimum Clearance for Servicing	18" from top, 24" from front, 4" sides and rear.
Maximum Water Supply Pressure	150 PSI
Thermostat Sensor	11,900 Ohms @ 70°F, ECO opens @ 200°F Max., ECO close @ 120°F Min. Redundant sensor for ECO. Sensor inside well for easy replacement of sensor.
Control Display	Digital display, 24 volts. Temperature Range: 70-180°F. Used to set tank temperature (°F or °C), show operating status, display error codes, error code history, limit maximum setpoint temperature.
Control Board	Operates from 24 volt from transformer. Controls tank temperature, ignition functions, combustion blower. See ignition timings in sequence of operation for Integrated Control.
Transformer	120VAC primary, 24VAC secondary, 40VA.
Spark Rod Igniter	0.22" nominal gap to the burner surface.
Flame Sensor Output	Minimum 1 micro amp, typical range 5 to 30 micro amps.
Gas Valve	Negative regulation, 24 VAC, ½" PSI max., 4.5" W.C. Minimum running inlet.
Vent Safety Switch	Normally closed, opens @ 350°F, manual reset.
Blocked Vent Pressure Switch	24VAC, normally closed, opens when pressure increases to +2.70 W.C.
Blower	120VAC, 60Hz, 1-4 amps

Sequence of Operation

1. Thermostat calls for heat.
2. Combustion blower starts.
3. Blower pre-purge period of 30 seconds.
4. Trial for Ignition (5 seconds, 3 trials).
 - a. Flame establishing period (3 seconds), gas valve opens, sparks from spark rod to burner surface to ignite the gas.
 - b. Burner on, flame proving period (2 seconds). Requires a minimum of 0.8 microamp through flame sense rod to prove flame.
 - c. If either blocked vent safety switch contacts (normally closed) or blocked vent pressure switch contacts (normally closed) are open, then the ignition sequence will not start and an error code 29 (Pressure switch failed to close or open) will be shown on the display.
5. Steady State Operation: Burner continues to operate until:
 - a. Thermostat circuit opens, gas valve closes, blower continues to operate for 30 second post-purge period.
 - b. If the normally closed blocked vent pressure switch opens, the gas valve closes, the blower continues to operate indefinitely and error code 29 will be displayed after a couple minutes with "Service Needed", "Pressure Switch".
 - c. If the normally closed 1st Pass Collector vent safety switch opens, the gas valve closes, the blower post-purges, then shuts off with error code 26 displayed in a lockout condition.
6. Thermostat satisfied.
7. Gas valve closes, burner extinguished.
8. Blower post purge for 30 seconds.

Lockout Conditions

The system will go into lock out mode for the following reasons:

1) ERROR CODE 62 or 63

Control board will go into "Soft Lockout" if the main burner cannot be lit or fails to prove flame after 3 ignition trials. The water heater display indicates a lockout condition by showing an error code number (62 or 63) with "Service Needed" in the control display window. Refer to error codes in the diagnostic section of this Service Manual. In a "Soft Lockout" condition, the control will wait for 60 minutes and then make 3 more attempts to light the main burners. Soft lockout reset is accomplished by depressing the lower right button under "Reset" for 3 seconds.

2) ERROR CODE 65

If the top of the tank should exceed 200°F, then the high limit control will shut off the burner and the water heater will go into a "Hard Lockout". Error code 65 will be shown in the water heater display. The control can only be reset in the "Service Mode," which is detailed in the "Troubleshooting" section of this Service Manual.

3) ERROR CODE 29

If the exhaust terminal becomes blocked or the condensate elbow fails to drain condensate, the normally closed exhaust pressure switch will open, the gas valve closes, and error code 29 will appear on the control display. When the condition is corrected, the error code will disappear, and the water heater will resume normal operation. No resetting of the control display is needed for the pressure switch error code.

4) ERROR CODE 26

If the vent safety switch located near the exhaust pressure switch should open, the gas valve will close, the blower will post-purge and error code 26 will appear on the display. The lockout condition will reset once the problem is corrected, and the switch reset. Refer to "Vent Safety Switch Testing and Replacement" in this Service Manual.

Troubleshooting

Water Heater Fault: Water heater does not operate.
Display Error Code: Water heater does not operate – blank display.

⚠ WARNING

120 volt potential exposure. Use caution making voltage checks to avoid personal injury.

Check main power supply to water heater – fuse, circuit breaker, plug receptacle, line cord, or wiring to water heater.

⚠ CAUTION

Use caution to not damage connectors when making voltage measurements or jumping terminals.

Check to make sure switch on front of control panel is in the ON position.

Verify primary voltage at the control board.

Refer to control board illustration. Voltage at primary pins **P2(1) & P2(3)** will be 110-120. If not, check line in pins **P3(1) & P3(4)**. Check line cord with volt meter. Replace line cord if defective.



Transformer
 Top terminals are 24VAC;
 Bottom terminals are 120VAC

Verify secondary voltage at the control board.

Refer to control board illustration. Voltage at secondary pins **P4(1) & P4(2)** will be 24 VAC. If not, check transformer. Replace transformer or wire harness.

Does the water heater display operate? Does the combustion blower start to operate? Increase thermostat setting if the tank is warm.

Display operates – see next page.

Is 24VAC present between **red & black** wire pin connections on the back of the control display?

Check wires for proper termination to control display. Are wire terminations connected properly to control display?

Replace control display.

N

Y

Y

N

N

Y

N

Is 24VAC present between E-COM screw terminal **P9(2) & P9(3)** on the control board.

Make proper wire terminations.

Check wire harness for proper continuity.

Replace control board.

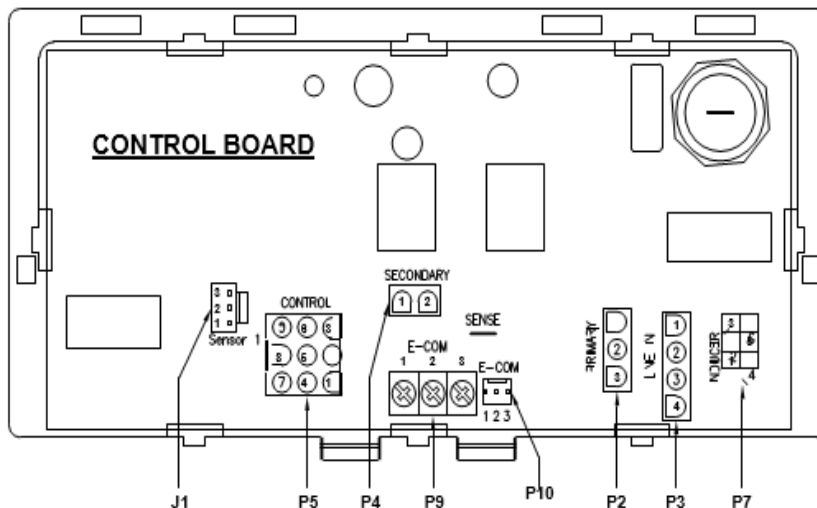

Troubleshooting

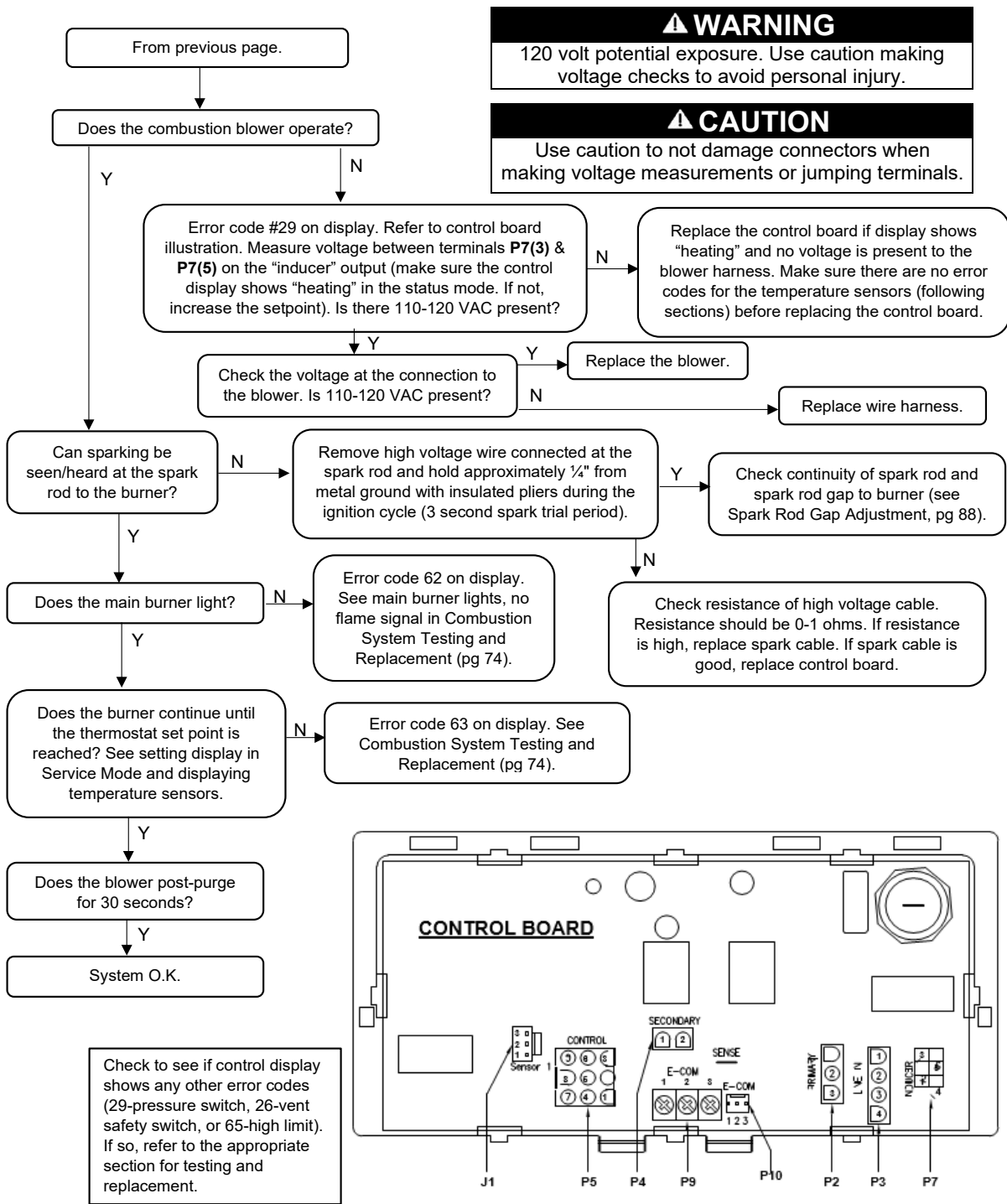

⚠ WARNING
120 volt potential exposure. Use caution making voltage checks to avoid personal injury.

⚠ CAUTION
Use caution to not damage connectors when making voltage measurements or jumping terminals.

Troubleshooting

Accessing Service Mode on Control Display (FOR SERVICE PERSONNEL ONLY)

The display has a “service mode” for changing the maximum setpoint and accessing information in aiding servicing of the water heater. This procedure is for service and installation personnel only. To enter the Service Mode, follow the steps illustrated below:

Step 1: Press Select and Temperature Up buttons together and hold for 3 seconds until “Max Setpoint” is shown in the display.

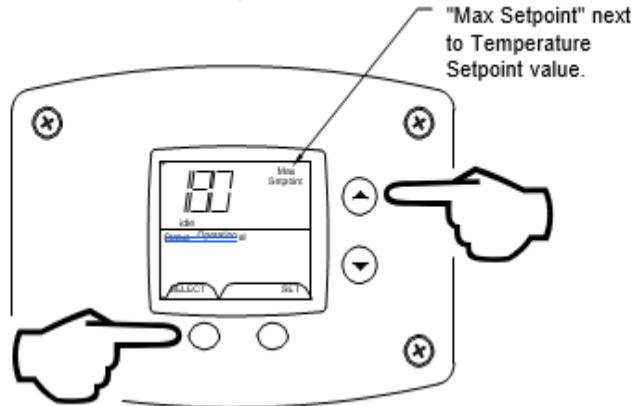

Step 2: Pressing Select button will change display to next mode.

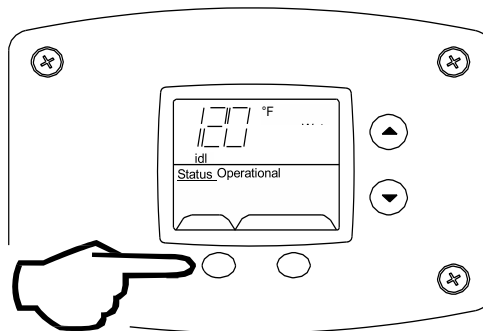

The following is the sequence of modes available in Service Mode by pressing the Select button.

Error Code Number (Display/Reset). This is only shown if there is an operating error in the User Mode.

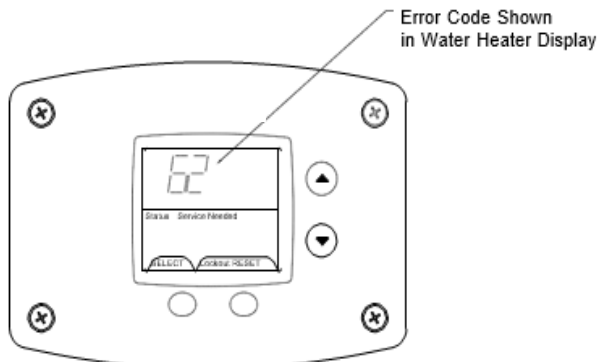

Sequence of Modes continued-

1. Max Setpoint (Display/Change)

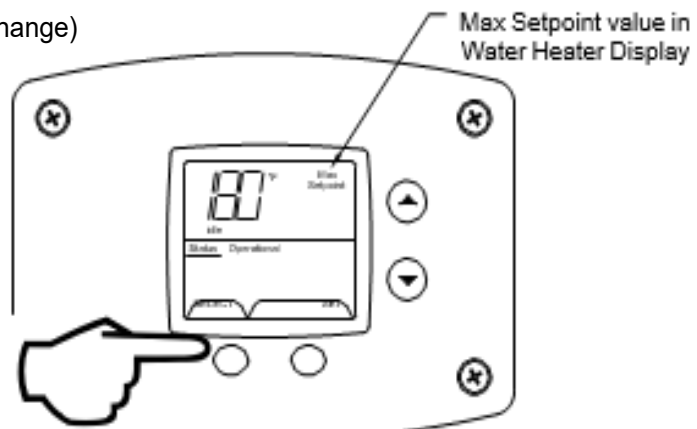

2. Tank Sensor Temperature, Displayed Water Temperature Average

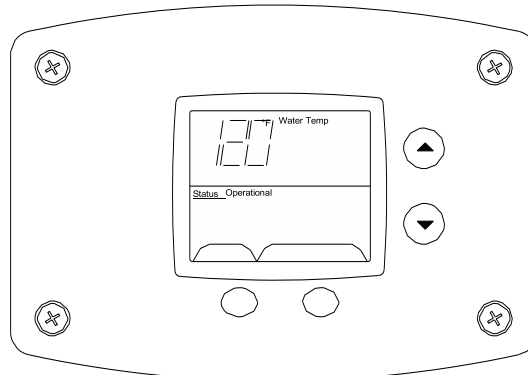

3. Flame Current of Burner Flame Sensor (Displays only in the Heating Cycle)

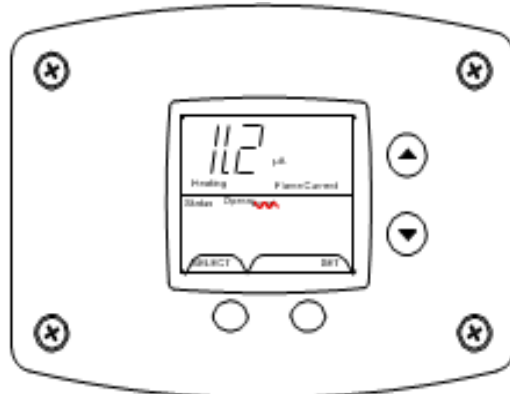

4. Setpoint (Display/Change)

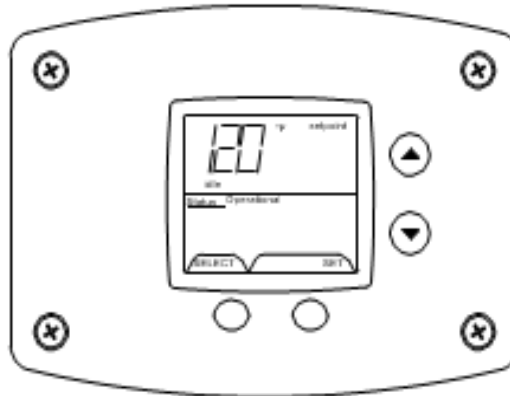

Sequence of Modes continued-

5. °F/°C (Display/Change)

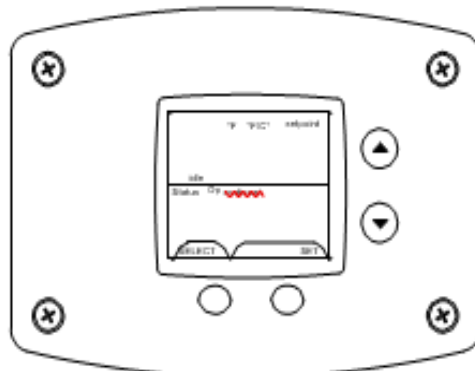

6. Differential (Display only – shows the differential of the thermostat)



7. Software Version (Display only)

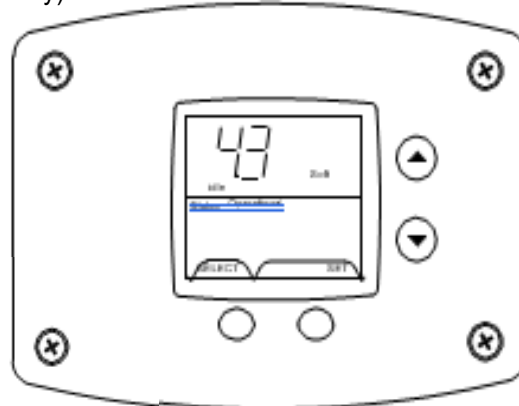

8. Error Code History (Displays if there are present error codes or up to 10 previous error codes). Water heater display will show a "--" if there are no error codes.

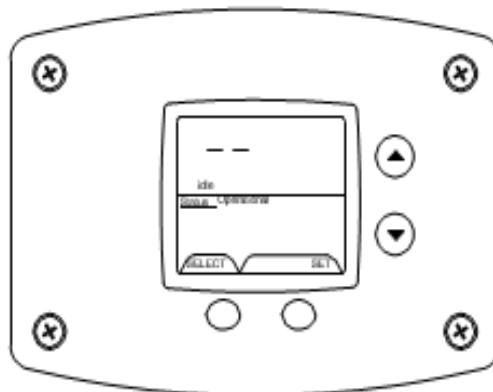

To change the Maximum Setpoint Limit (Max Setpoint) for the temperature setpoint:

Step 1: In Service Mode press the Select button until Max Setpoint is displayed.

WARNING!
Setting the water temperature to the maximum setpoint can result in scalding hot water delivered to the faucets. It is highly recommended that the maximum setpoint be adjusted to the lowest temperature possible for the needs of the installation. Make sure the water heater control display is not in a public area that can result in the temperature settings being improperly adjusted.

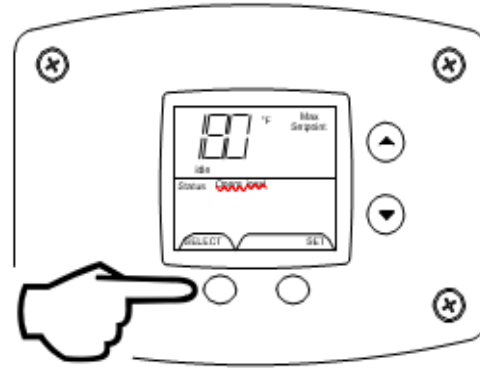

Step 2: Press Set button to enter setting mode. Max Setpoint will flash to indicate setting mode.

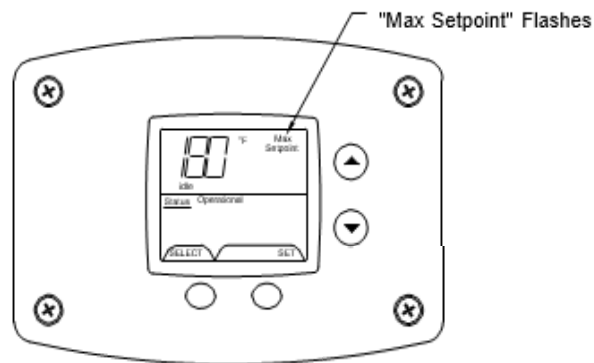

Step 3: Press the UP or DOWN buttons to change the maximum setpoint value. This will limit the maximum setpoint the user can select. Note: The maximum setpoint is approximately 180°F.

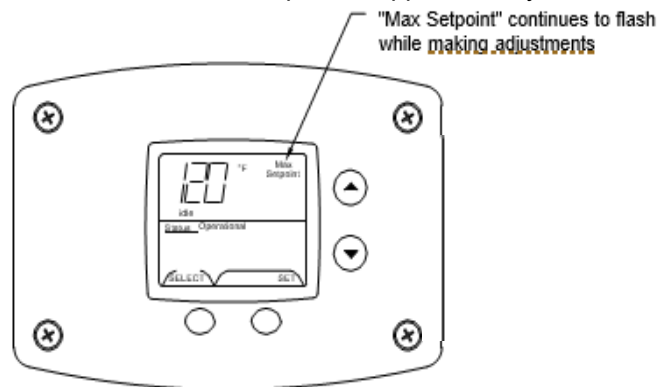

Step 4: Press Set button to confirm new Max Setpoint value and stop setting mode.

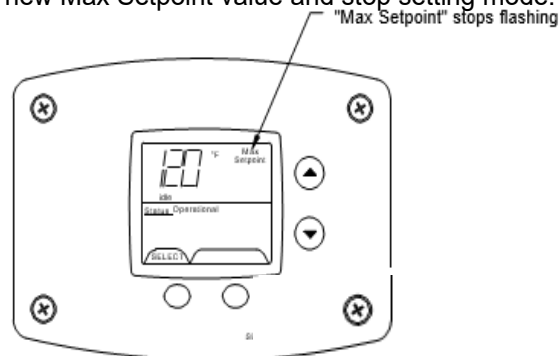

Max Setpoint Limit continued-

Step 5: 30 seconds after the last button press, the water heater display will go back to User Mode. It will read “Max Setpoint” without showing a temperature value if the temperature setpoint is at the maximum setting. The water heater display can be set back to the User Mode immediately by pressing both the Temperature Up and Select buttons together for 3 seconds.

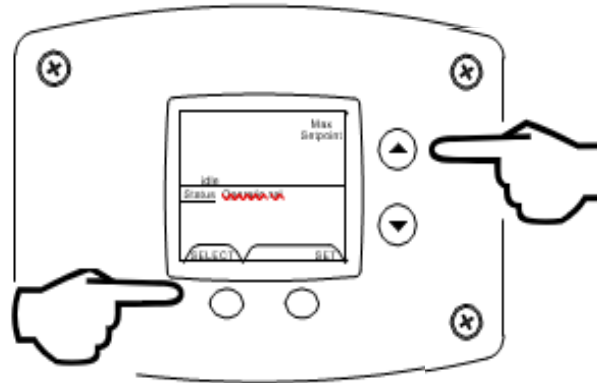

Exiting Service Mode

Display of Water Temperature:

In Service Mode, press the Select button until “Water Temp” is displayed in the upper right section of the water heater display. This is the reading for the sensor.

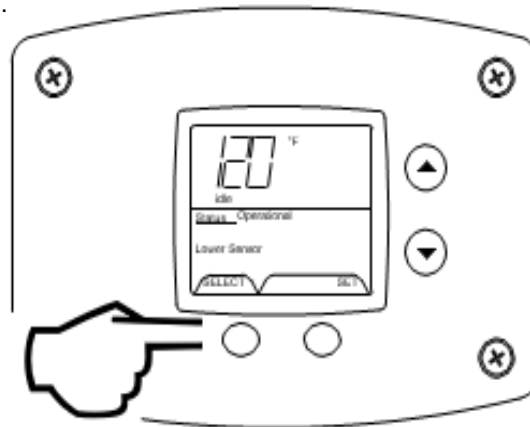

To Display Flame Sense Current of the Pilot Flame Sensor:

The pilot flame sense current is available only when the burner is in operation. **Step 1:** Make sure the status displays “Heating” or draws enough hot water to start the burners. **Step 2:** Enter the Service Mode described previously. **Step 3:** Press the Select button until a number value is displayed with “Flame Current” to the right of the number. The value is in microamps (μA).

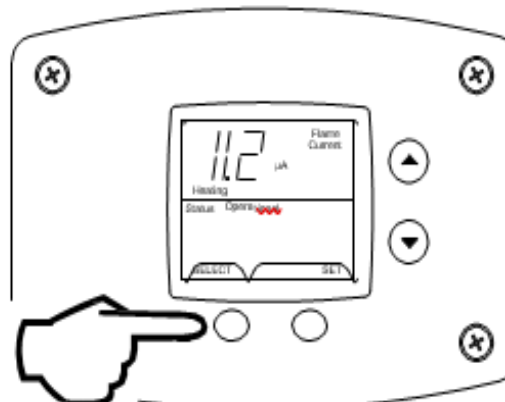

To Display and Change Temperature Setpoint:

Step 1: In Service Mode, press the Select button until “Setpoint” is shown in the water heater display.

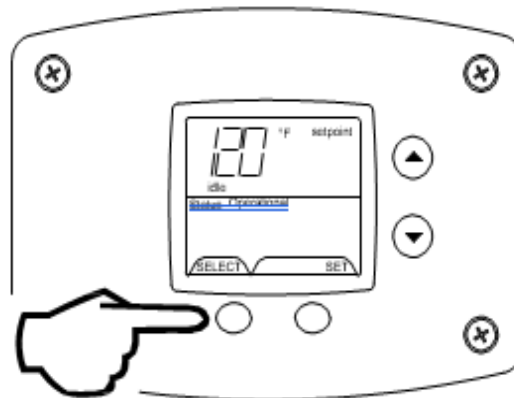

Step 2: Press the Set button to enter the setting mode. “Setpoint” will flash in the water heater display.

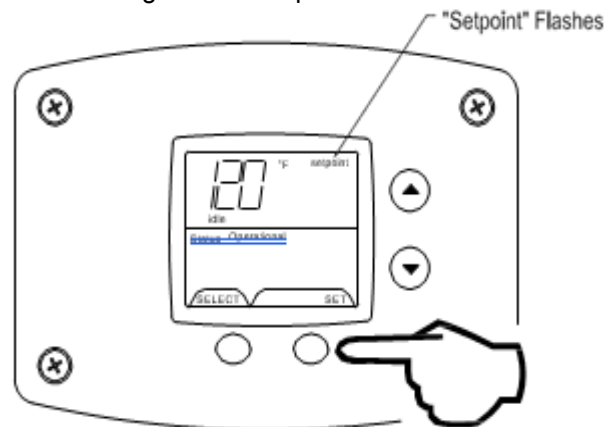

Step 3: To raise the temperature setpoint, press the Temperature Up button until the desired temperature is shown in the water heater display.

NOTICE

The maximum temperature that can be set in the water heater display is limited to the Max Setpoint previously described. To change the Max Setpoint, refer to the procedure To Change the Maximum Setpoint Limit described previously under Accessing the Service Mode on the Water Heater Display

⚠ WARNING

Setting the water temperature to the maximum setpoint can result in scalding hot water delivered to the faucets. It is highly recommended that the maximum setpoint be adjusted to the lowest temperature possible for the needs of the installation. Make sure the water heater control display is not in a public area that can result in the temperature settings being improperly adjusted.

Change Temperature Setpoint continued-

Step 4: To lower the temperature setpoint, press the “Temperature Down” button until the desired temperature is shown on the water heater display.

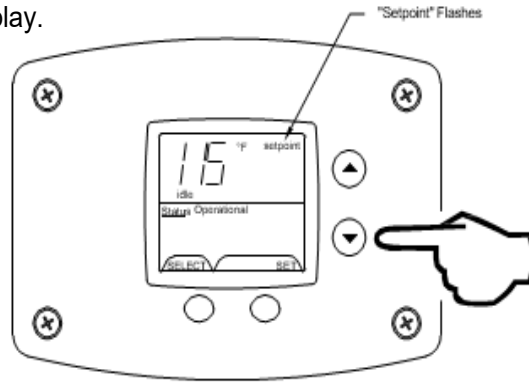

Step 5: When the desired setpoint is reached on the water heater display, press the Set button to confirm the new setpoint. “Setpoint” stops flashing in the water heater display.

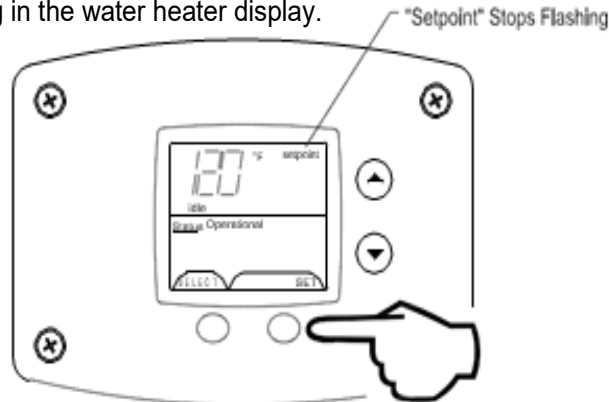

To Change Temperature Format in Display from °F to °C or °C to °F:

Step 1: While in Service Mode, press the Select button until “F/°C” is shown in the upper right corner of the water heater display.

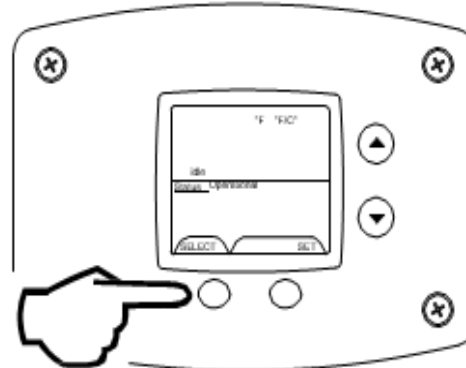

Step 2: Press the Set button to change the temperature format. The “F/°C” symbol will flash in the water heater display.

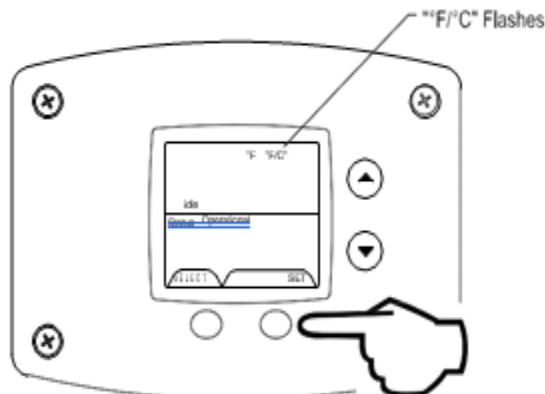

Change Temperature Format in Display continued-

Step 3a: Press the Temperature Up button to change temperature format to °C.

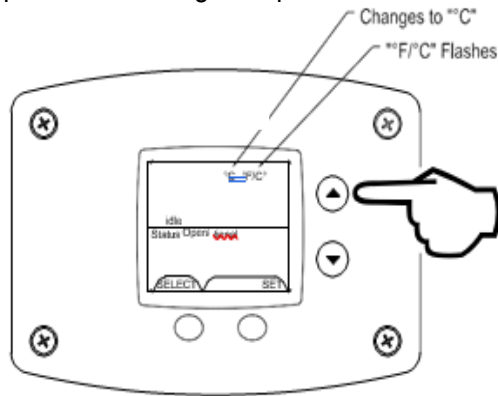

Step 3b: Press the Temperature Up button to change temperature format to °F.

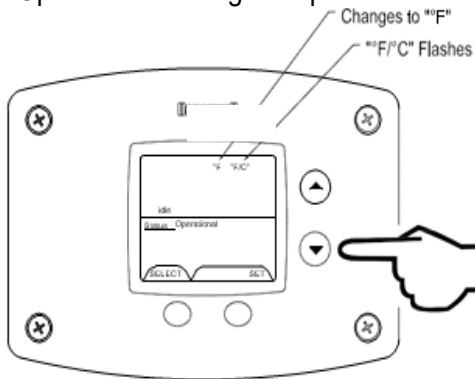

Step 4: Press the Set button to confirm °F or °C format. "°F/°C" will stop flashing in the water heater display.

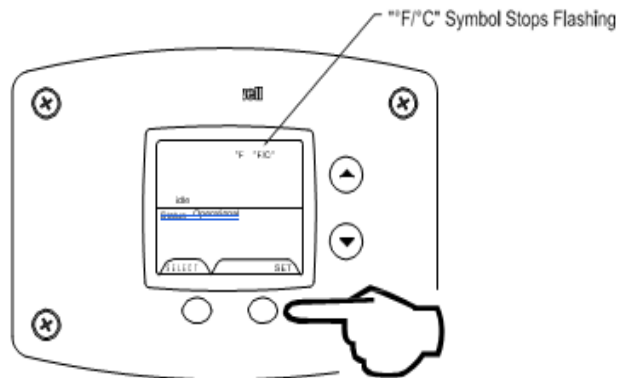

Step 5: Pressing the Select button will return the display to setpoint in format selected (°F or °C) immediately.

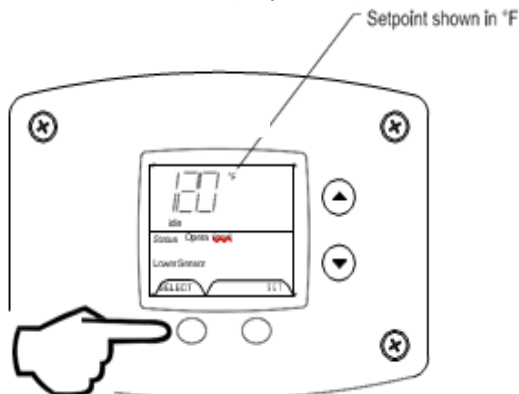

Error Codes and Error History Display:

If there is an operating problem with the water heater, an error code number will appear on the water heater display with "Service Needed" to the right of the "Status" indicator. The error code label is located under the Water Heater Display and the following section in this Service Manual explains the error codes with corrective actions to repair the water heater.

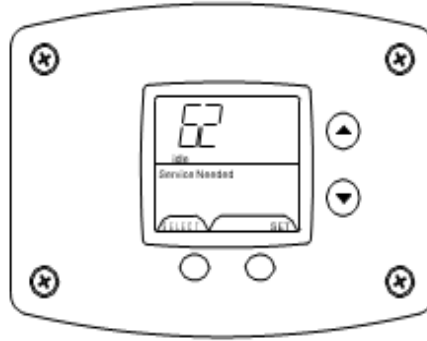

Example of Error Code in the Display

Error Code History:

In Service Mode pressing the Select button after the Software Version (item 8 in the previously described sequence of service modes) will show an error code history, if there have been any previous operating problems with the water heater. If the display shows "--", there is not a current error code. The water heater display will provide up to 10 previous error codes. The oldest error code will be stored in code index #1 and the most recent in code index #10.

To View Previous Error Codes:

Step 1: In "Service Mode" press the Select button until the next display after the Software Version. If there are no current error codes, the display will show "--".

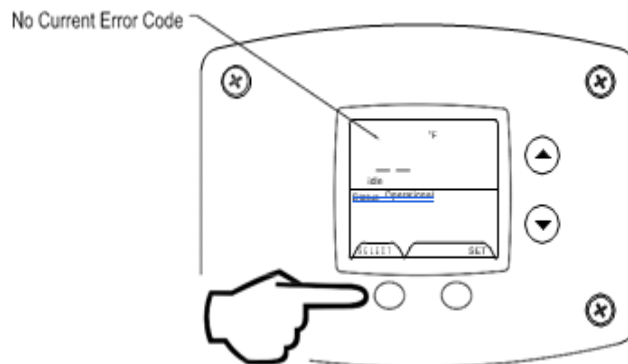

Step 2: Press the Temperature Down button to select the error code index, starting with the most recent error code 10.

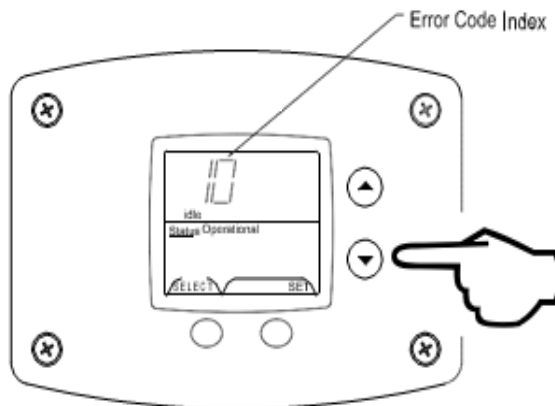

View Previous Error Code continued-

Step 3: Press the Select button to view the error code for code 10. If there is a number displayed, note what the number is. The label next to the water heater display will identify the code number. If no number is displayed with only a "--" in the water heater display, then there has not been an error code for error code index 10.

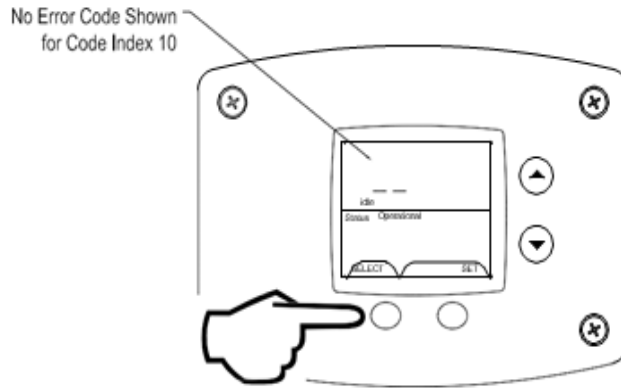

Step 4: Press the Temperature Down button to change the previous code index, code 9.

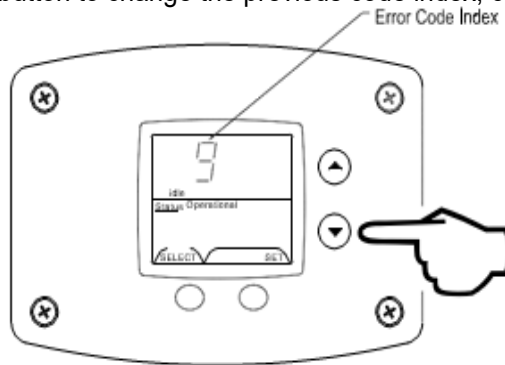

Step 5: Press the Select button for code index 9 to view if there are any code numbers.

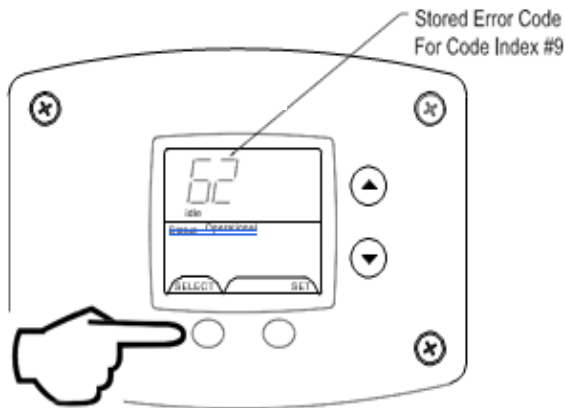

Step 6: Continue pressing the Temperature Down button to change to the next error code index and press Select to view the error code number, if any, for that index number. Continue on to index 1, the oldest error code index. The water heater display will store up to 10 error codes with the oldest code starting in code index 1 with the most recent code in code index 10.

View Previous Error Code continued-

Step 7: 10 seconds after the last button press, the Water Heater Display will revert back to the current error code display. To exit Service Mode, either wait 30 seconds or press Temperature Up button and Select button for 3 seconds.

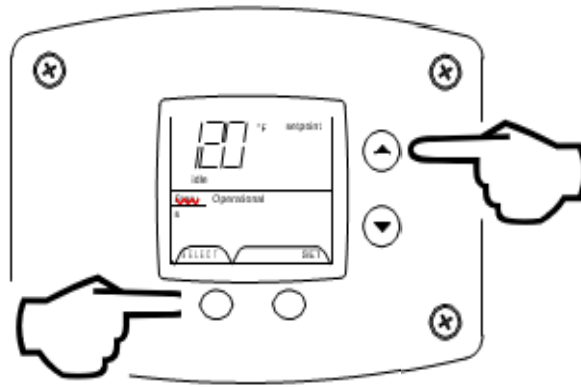

Exiting Service Mode

Error Code Definitions

If the water heater has an operating problem, there will be a number in the water heater display with “Service Needed” shown below the error code number. Note the error code and the definition in the chart below. This label appears on the control box under the water heater display. The following sections will provide instructions for servicing each error code.

INTEGRATED CONTROL ERROR CODE DISPLAY	
ERROR CODE	DEFINITION
4	LOW FLAME SENSE CURRENT
6	FLAME SENSED OUT OF NORMAL SEQUENCE (BEFORE OPENING GAS VALVE OR AFTER CLOSING GAS VALVE)
23	FLAME DETECTED BEFORE IGNITION
24	FLAME DETECTED AFTER A HEATING CYCLE COMPLETES
29	PRESSURE SWITCH FAILED TO CLOSE OR OPEN (STUCK OPEN)
32	LOWER SENSOR READINGS FAULTY
57	FLAME ROD SHORTED TO GROUND
58	AC LINE FREQUENCY ERROR - SIGNAL TOO NOISY OR FREQUENCY INCORRECT
59	LINE VOLTAGE TOO LOW OR HIGH
61	DC OUTPUT VOLTAGE UNSTABLE
62	MAXIMUM NUMBER OF RETRIES DETECTED
63	MAXIMUM NUMBER OF IGNITION RECYCLES DETECTED
64	ELECTRONICS FAILURE
65	HIGH WATER TEMPERATURE (OVER 200°F)
IF ANY OF THE ABOVE CODES APPEAR ON THE CONTROL DISPLAY, CONTACT YOUR PLUMBER OR QUALIFIED SERVICE AGENT FOR SERVICE OF THE WATER HEATER.	

Troubleshooting

Resetting Error Codes

WARNING

The following procedure is for **service and installation personnel ONLY**. Resetting lockout conditions without correcting the malfunction can result in a hazardous condition.

If an error code is displayed (except for 4, low flame sense current), the water heater will be in a Lockout Condition with the water heater display showing the error code number and “Service Needed” in the status section of the display window. Error codes 62 (maximum number of retries detected) and 63 (maximum number if ignition recycles detected) are Soft Lockouts in which the control can be reset in the User Mode by pressing the lower right button under Lockout Reset, shown in the lower right portion of the display. The control will also go through 3 attempts to relight the burners every hour in the soft lockout condition.

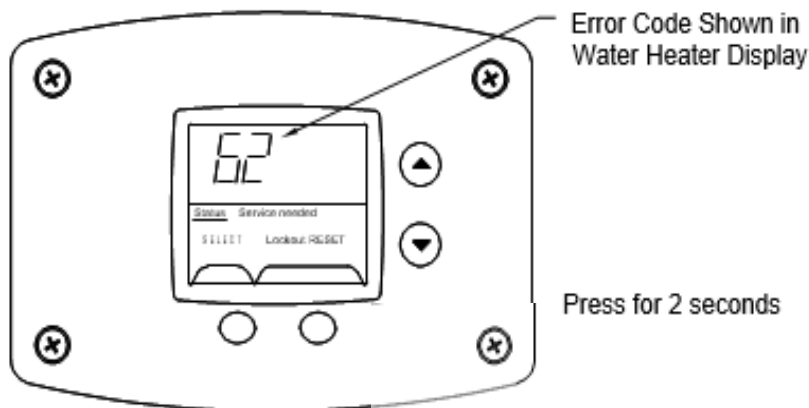

All other error codes will put the water heater into a Hard Lockout condition, in which the water heater will not operate and cannot be reset in the User Mode. To reset a Hard Lockout, first enter the Service Mode described earlier by pressing both the Temperature Up and Select buttons at the same time for 3 seconds. Then press the lower right button under Lockout Reset in the water heater display and hold for 3 seconds.

Resetting Error Codes in Hard Lockout Condition

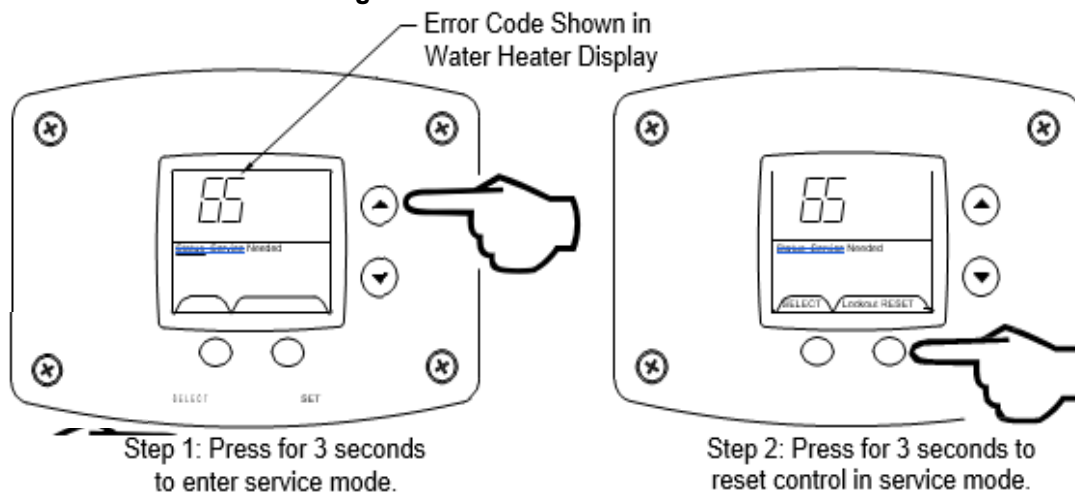

Service Procedure I

Thermostat Circuit Testing and Replacement

NOTE: This procedure assumes a cool tank.

⚠ WARNING
120 volt potential exposure. Use caution making voltage checks to avoid personal injury.

⚠ CAUTION
Use caution to not damage connectors when making voltage measurements or jumping terminals.

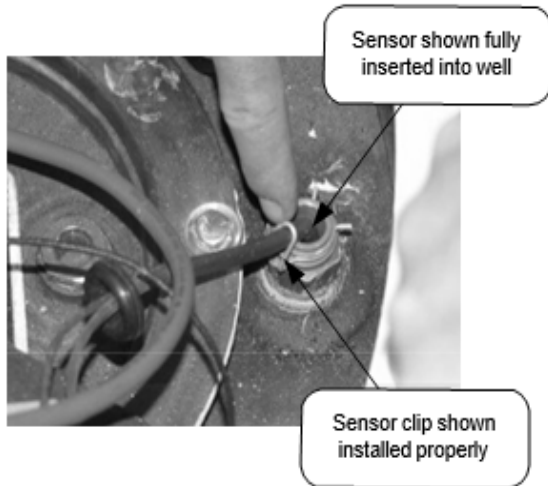
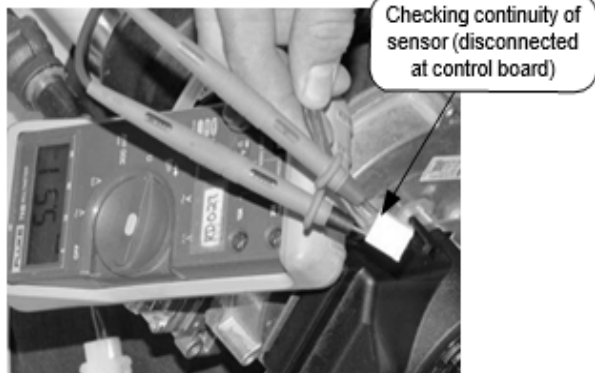
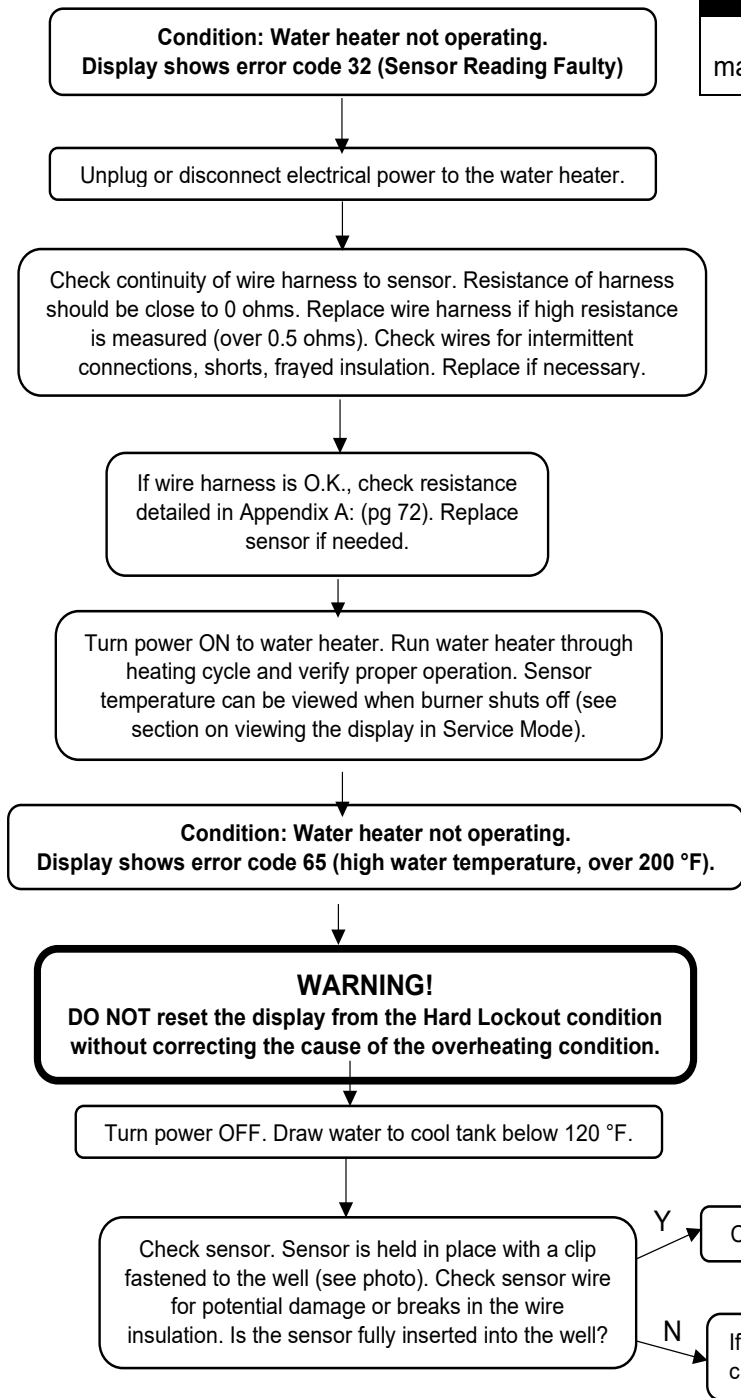

Service Procedure I

Thermostat Circuit Testing and Replacement (Continued)

⚠ WARNING

DO NOT operate the water heater without verifying that the overheating condition has been corrected.

Continued from previous page.

**Condition: Water heater not operating.
Display shows error code 65 (high water temperature, over 200 °F).**

Once cause of overheating condition has been diagnosed and corrected, the control may be reset.

- Reconnect and switch ON power to the water heater.
- Enter service mode on the water heater display (see image below).
- Press button under "Lockout Reset" and hold for 3 seconds.
- Set thermostat to the desired setting.
- Water heater will start.
- Monitor temperatures for one complete heating cycle making sure the maximum tank temperature remains well below 200 °F.

This water heater is equipped with a manual reset type gas shutoff device designed to shut off the gas to the burners if excessive water temperature occurs. To reset the control, first press the "temperature up" and "select" buttons on the water heater display for 3 seconds to enter service mode. Then press the lower right button under "RESET" in the display for 3 seconds.

Error code 65 indicates high limit lockout condition

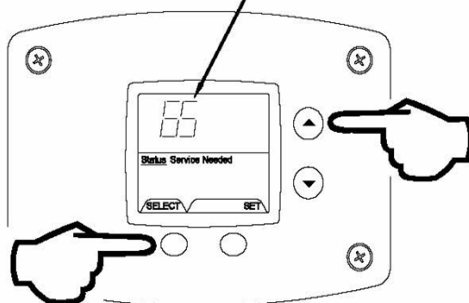

Step 1: Press for 3 seconds to enter service mode.

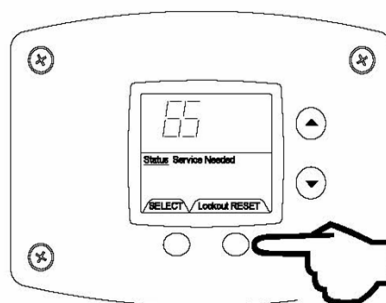

Step 2: Press for 3 seconds to reset control.

Service Procedure I

Thermostat Circuit Testing and Replacement (Continued)

Appendix – A Sensor Resistance at Various Temperatures

Be careful when making voltage measurements or jumping terminals NOT to damage or deform connectors or connector pins.

Draw water from the Temperature and Pressure Relief Valve. Compare the Temperature with Temperature Ohms Chart below.

Example: If temperature of the sensor is 84 °F, then the resistance through the sensor would be 8449 (see shaded area).

NOTE: Sensor resistance increases as the temperature falls.

In Degrees F										
°F	0	1	2	3	4	5	6	7	8	9
40	26109	25400	24712	24045	23399	22771	22163	21573	21000	20445
50	19906	19383	18876	18383	17905	17440	16990	16553	16128	15715
60	15314	14925	14548	14180	13823	13477	13140	12812	12494	12185
70	11884	11592	11308	11032	10763	10502	10248	10000	9760	9526
80	9299	9078	8862	8653	8449	8250	8057	7869	7685	7507
90	7333	7165	7000	6839	6683	6531	6383	6238	6098	5961
100	5827	5697	5570	5446	5326	5208	5094	4982	4873	4767
110	4663	4562	4464	4368	4274	4183	4094	4006	3922	3839
120	3758	3679	3602	3527	3453	3382	3312	3244	3177	3112
130	3048	2986	2925	2866	2808	2752	2697	2643	2590	2538
140	2488	2439	2391	2344	2298	2253	2209	2166	2124	2083
150	2043	2004	1966	1928	1891	1856	1820	1786	1753	1720
160	1688	1656	1625	1595	1566	1537	1509	1481	1454	1427
170	1402	1376	1351	1327	1303	1280	1257	1235	1213	1191
180	1170	1150	1129	1110	1090	1071	1053	1035	1017	999
190	982	965	949	933	917	901	886	871	857	842
200	828	814	801	788	775	762	749	737	725	713

Appendix – B Temperature Dial Resistance

Proper readings should be 5400-6600 Ohms at minimum setting and 0-50 Ohms at maximum setting.

Be careful when making voltage measurements or jumping terminals NOT to damage or deform connectors or connector pins.

Service Procedure I

Thermostat Circuit Testing and Replacement (Continued)

Thermostat Sensor (Thermister) Replacement Procedure

1. Position main power switch to OFF.
2. Disconnect (unplug) the water heater from 120 volt power source.
3. Unlatch and remove the top of the surround cover from the top of the water heater.
4. Fold back the insulation just in front of the burner to expose the temperature sensor (see image at right).
5. Disconnect temperature sensor from harness (see images at right).
6. Unclip the sensor from the well and pull the sensor to remove, do NOT remove the well.
NOTE: Using a deep well socket will allow room inside socket for sensor connector and wires.
7. Install the new sensor completely into the well and reinstall the sensor clip.
8. Fold the insulation back into place. Be sure there are no wires in contact with the burner.
9. Restore 120 volt power supply and water supply to the water heater, check and repair any leaks found. Confirm proper operation following the lighting instruction label or the lighting instruction located in the Installation and Operating Instruction Manual.
10. Replace the surround cover on the top of the water heater.

⚠ WARNING

120 volt potential exposure. Isolate the appliance and reconfirm power is disconnected using a multi-meter.

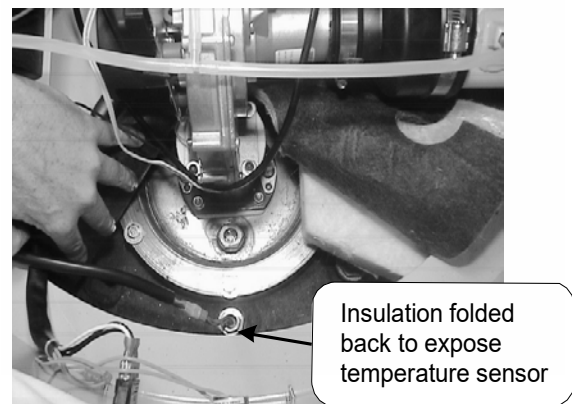
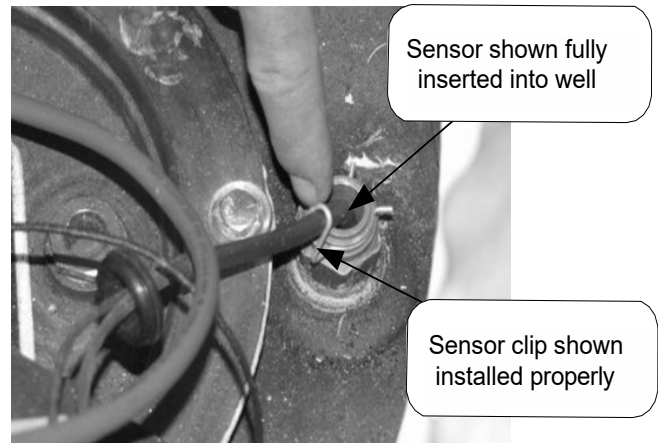

Service Procedure II

Combustion System Testing and Replacement

Observe burner operation through the sight glass located on the combustion insert mounting flange. Normal burner operation should ignite smoothly, without evidence of coughing or huffing upon ignition. The burner flame should be a blue flame near the burner surface in a uniform flame pattern. Occasional yellow or white streaks are normal.

Note: On higher input models using metal fiber mesh burner a red glow from the burner surface is normal.

⚠ WARNING
120 volt potential exposure. Use caution making voltage checks to avoid personal injury.

⚠ WARNING
Removing screw from inlet gas pressure tap will immediately allow gas to flow from pressure tap.

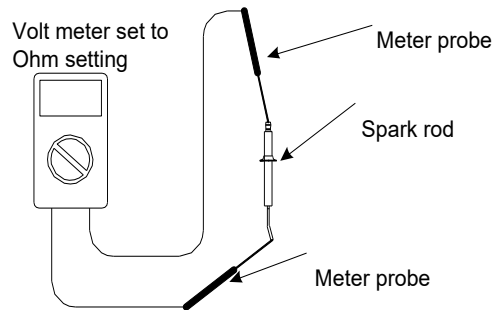
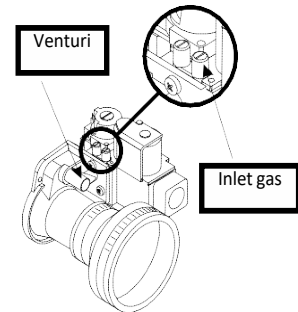
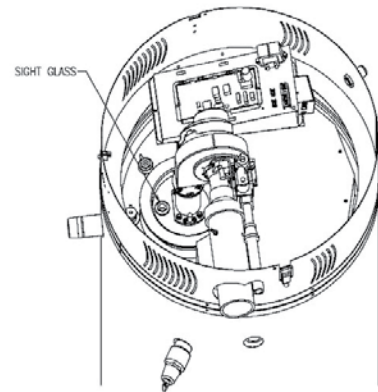
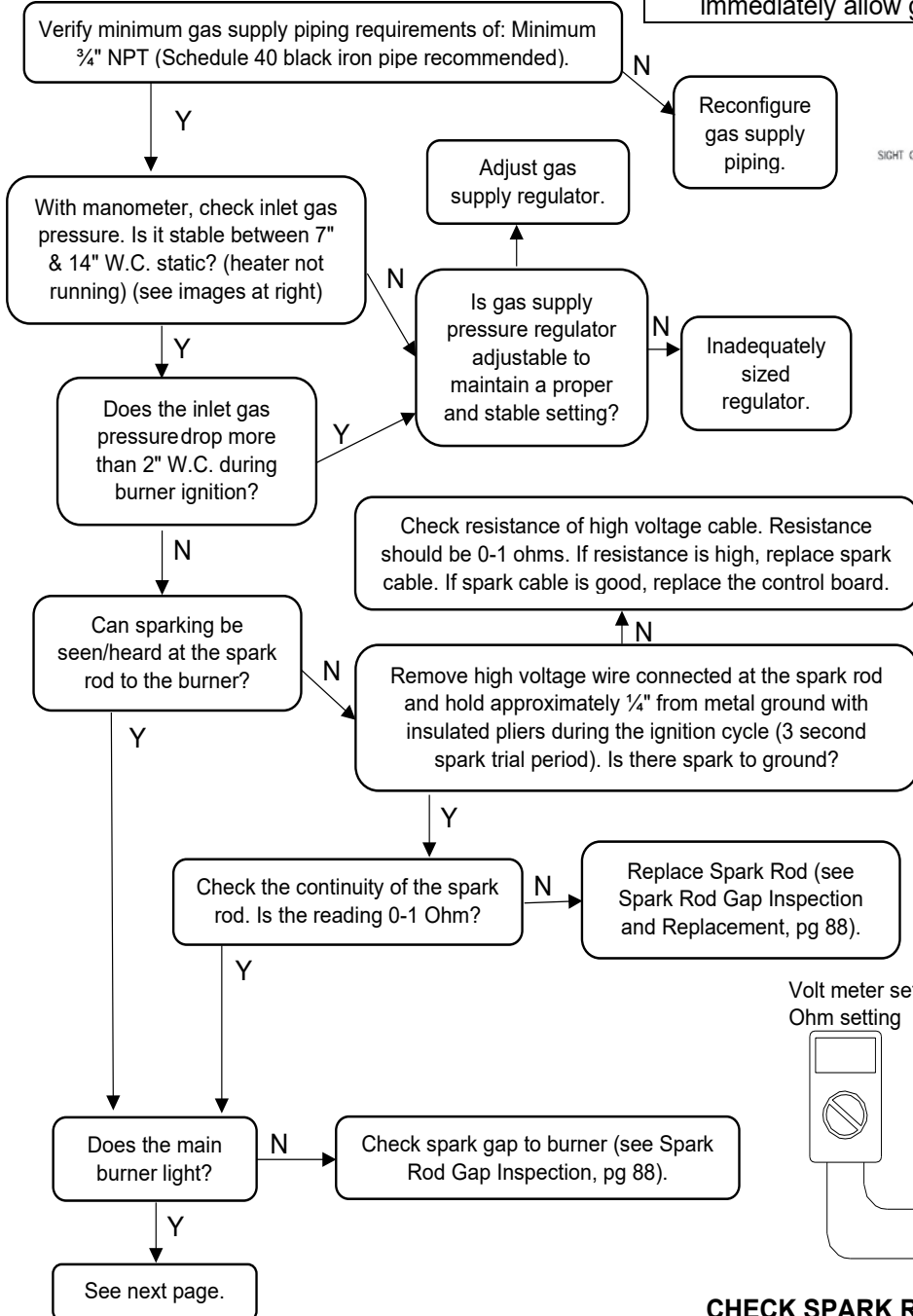

CHECK SPARK ROD RESISTANCE

Service Procedure II

Combustion System Testing and Replacement (Continued)

Observe burner operation through the sight glass located on the combustion insert mounting flange. Normal burner operation should ignite smoothly, without evidence of coughing or huffing upon ignition. The burner flame should be a blue flame near the burner surface in a uniform flame pattern. Occasional yellow or white streaks are normal.

⚠ WARNING

120 volt potential exposure. Isolate the appliance and reconfirm power is disconnected using a multi-meter.

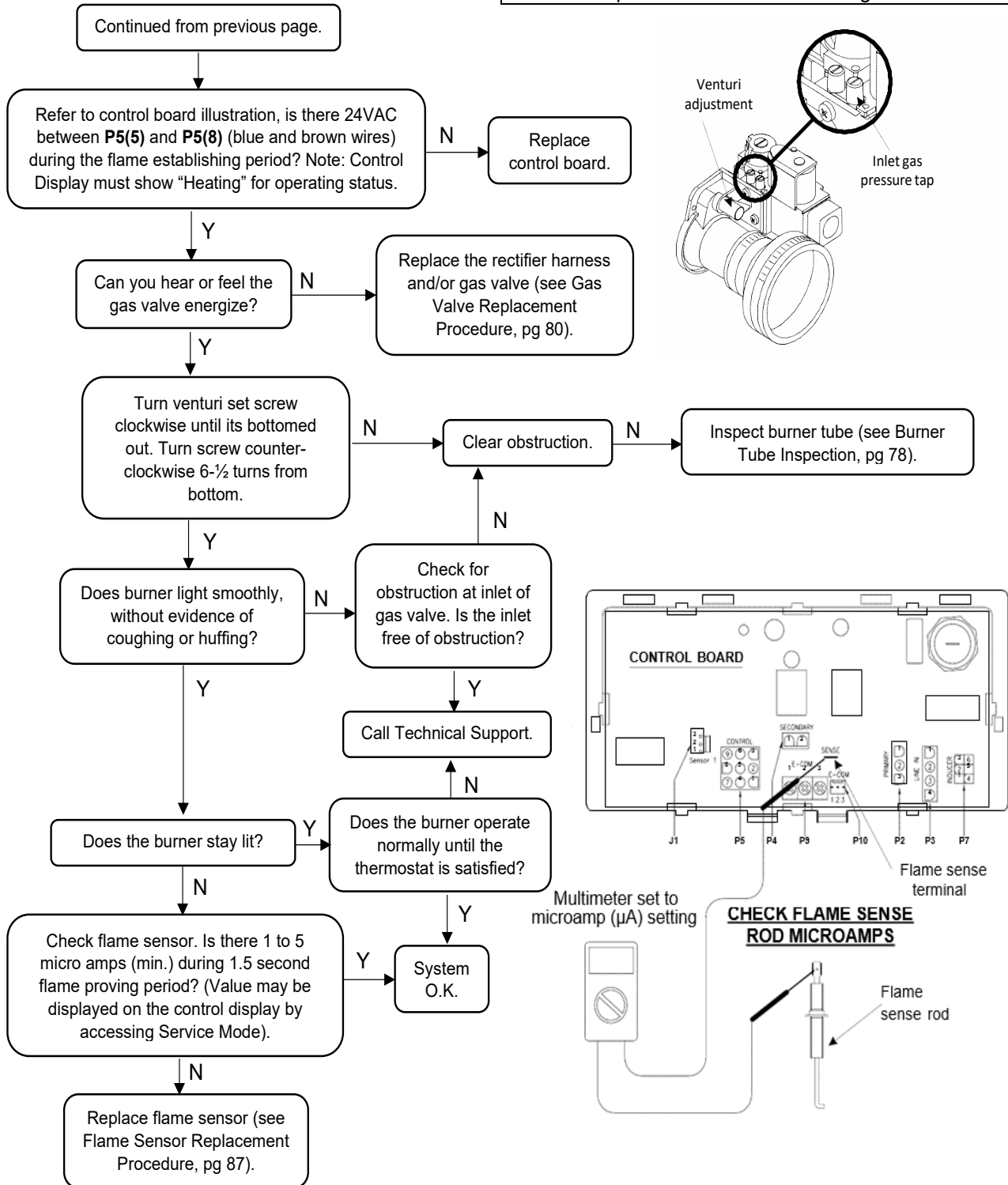

Service Procedure II

Combustion System Testing and Replacement (Continued)

Combustion System Removal Procedure

1. Position main power switch to OFF.
2. Disconnect (unplug) water heater from 120 volt power source.
3. Turn OFF gas supply to the water heater.
4. Unlatch and remove the surround cover from the top of the water heater.
5. From the gas valve, disconnect the gas connection, PVC venting, silicone tubing, and wire harness.
6. Disconnect the wire harnesses, flame sensor, and blower. Disconnect high voltage cable from the spark rod connection.
7. Remove the 5 bolts (1/2" socket) holding the burner mounting insert in place.
8. Carefully remove combustion assembly with gasket from the water heater.
9. See next page for combustion system installation procedure.

⚠ WARNING

120 volt potential exposure. Isolate the appliance and reconfirm power is disconnected using a multi-meter.

⚠ WARNING

Heater components may be HOT when performing the following steps in this procedure. Take necessary precaution to prevent personal injury.

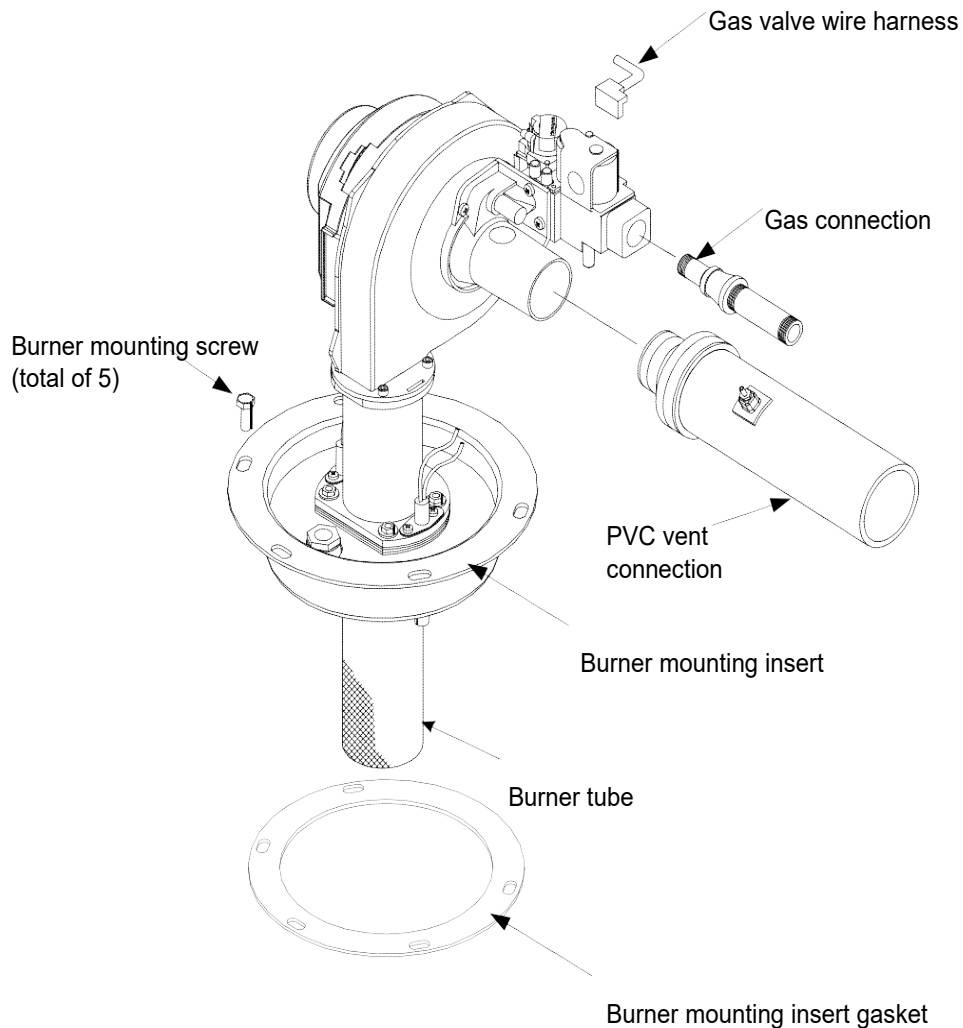

Service Procedure II

Combustion System Testing and Replacement (Continued)

Combustion System Replacement Procedure

1. Fully inspect burner mounting insert gasket for the following:
 - a) Tears
 - b) Missing material
 - c) Cracks
 - d) Dirt or debris
 - e) Other imperfections that would inhibit proper sealIf gasket is NOT affected by any of the above, gasket replacement is not required.
2. Install combustion assembly using new gasket or fully inspected gasket from step 1. Secure combustion assembly at the burner mounting insert using screws from step 6 on previous page. Tighten screws evenly.
3. Reconnect wire harnesses to igniter or high voltage cable to spark rod, flame sensor, blower, and gas valve.
4. Reconnect PVC venting, gas supply and silicone tubing to gas valve. Turn on gas supply to heater and check for gas leaks, repair any gas leaks found.
5. Restore 120 volt power supply to water heater and confirm proper operation following the lighting instructions on the lighting instruction label or the lighting instruction located in the Installation and Operating Instruction Manual.
6. Replace the surround cover on the top of the water heater.

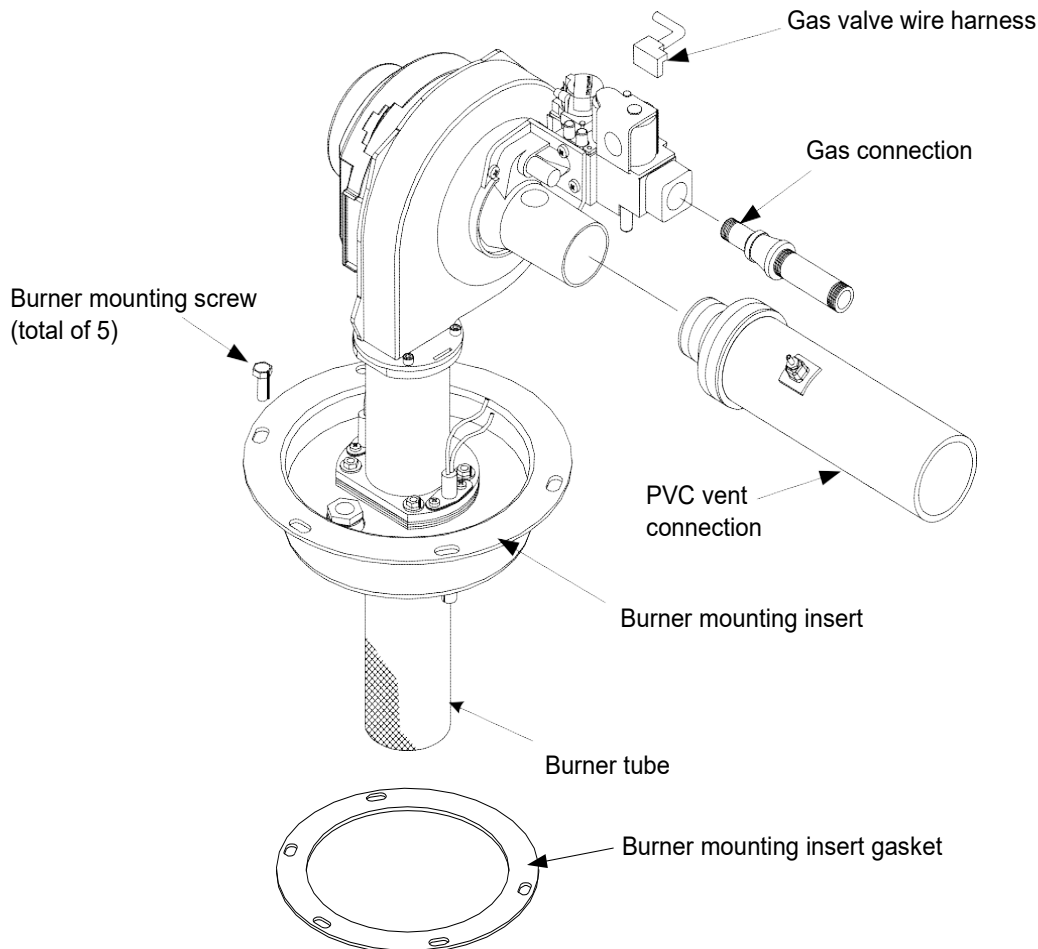

Service Procedure III

Burner Tube Inspection and Replacement

Burner Tube Removal Procedure

1. Position main power switch to OFF.
2. Disconnect (unplug) water heater from 120 volt power source.
3. Turn OFF gas supply to the water heater.
4. Unlatch and remove the surround cover from the top of the water heater.
5. From the gas valve, disconnect the gas connection, PVC venting, silicone tubing, and wire harness.
6. Disconnect the wire harness from the blower assembly.
7. Carefully remove the flame sensor from combustion assembly. Remove the two screws on the spark rod bracket and remove the spark rod.
8. Remove the 4 nuts (7/16" wrench) holding the burner transition in place. Lift the blower/gas valve transition assembly from burner mounting insert, remove gasket and set aside.
9. Remove burner tube from burner mounting insert. See next page for burner tube inspection procedure.

⚠ WARNING

120 volt potential exposure. Isolate the appliance and reconfirm power is disconnected using a multi-meter.

⚠ WARNING

Heater components may be HOT when performing the following steps in this procedure. Take necessary precaution to prevent personal injury.

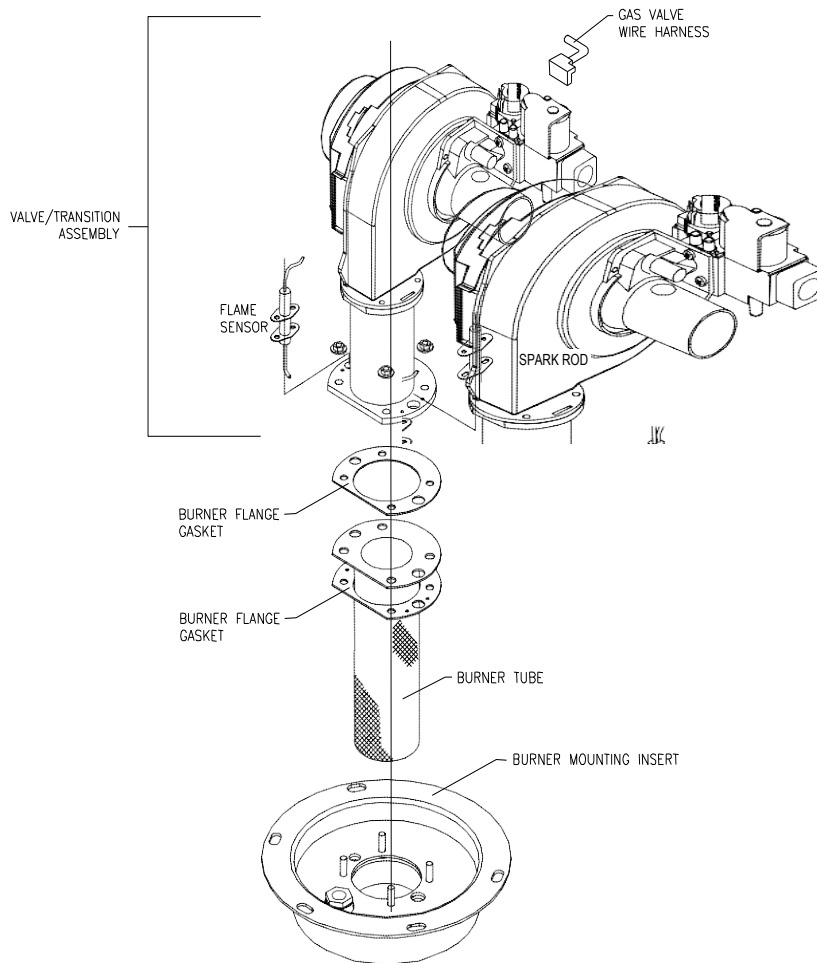

Service Procedure III

Burner Tube Inspection and Replacement (Continued)

⚠ WARNING

Heater components may be HOT when performing the following steps in this procedure. Take necessary precaution to prevent personal injury.

1. **Inspect burner tube as follows:**
 - a) Outer fiber mesh should be uniform with no tears or deterioration.
2. If burner tube is affected by any of the above, replacement is required. Refer to burner tube replacement procedure below.

Burner Tube Replacement Procedure

Note: Provide the model and serial number for the correct replacement burner.

1. Fully inspect burner flange gaskets, igniter and flame sensor gaskets for the following:
 - a) Tears
 - b) Missing material
 - c) Cracks
 - d) Dirt or debris
 - e) Other imperfections that would inhibit proper sealIf gaskets are NOT affected by any of the above, gasket replacement is not required.
2. Install burner tube with gaskets into burner mounting insert. Be sure gasket surfaces are free of debris.
3. Reconnect the blower/gas valve/transition assembly to burner mounting insert. Secure using nuts from step 8 on previous page.
4. Carefully reinstall flame sensor with gasket and igniter with gasket and secure with screws from step 7 on previous page. Reconnect wire harnesses to sensor and igniter.
5. Reconnect wire harnesses to blower motor and to the gas valve.
6. Reconnect PVC venting, gas supply and silicone tubing to gas valve. Turn on gas to heater and check for gas leaks, repair any gas leaks found.
7. Restore 120 volt power supply to water heater and confirm proper operation following the lighting instructions on the lighting instruction label or the lighting instruction located in the Installation and Operating Instruction Manual.
8. Replace the surround cover on the top of the water heater.

Service Procedure IV

Gas Valve Replacement

Gas Valve Replacement Procedure

⚠ WARNING

120 volt potential exposure. Isolate the appliance and reconfirm power is disconnected using a multi-meter.

1. Position main power switch to OFF.
2. Disconnect (unplug) water heater from 120 volt power source.
3. Turn OFF gas supply to water heater.
4. Unlatch and remove the surround cover from the top of the water heater.
5. From the gas valve, disconnect the gas connection, PVC venting, wire harness, and silicone tubing.
6. Remove the two gas valve mounting screws (Torx bit) located on the venturi mounting flange and remove gas valve from water heater.
7. Remove any residual gasket material from blower and venturi mounting flange.
8. Install new gas valve with new gasket provided. Secure gas valve in place using screws from step 6.
9. Reconnect PVC venting, gas supply, silicone tubing, and wire harness to the gas valve. Turn ON gas supply to heater and check for gas leaks, repair any gas leaks found.
10. Restore 120 volt power supply to water heater and confirm proper operation following the lighting instructions on the lighting instruction label or the lighting instruction located in the Installation and Operating Instruction Manual.
11. Replace the surround cover on the top of the water heater.

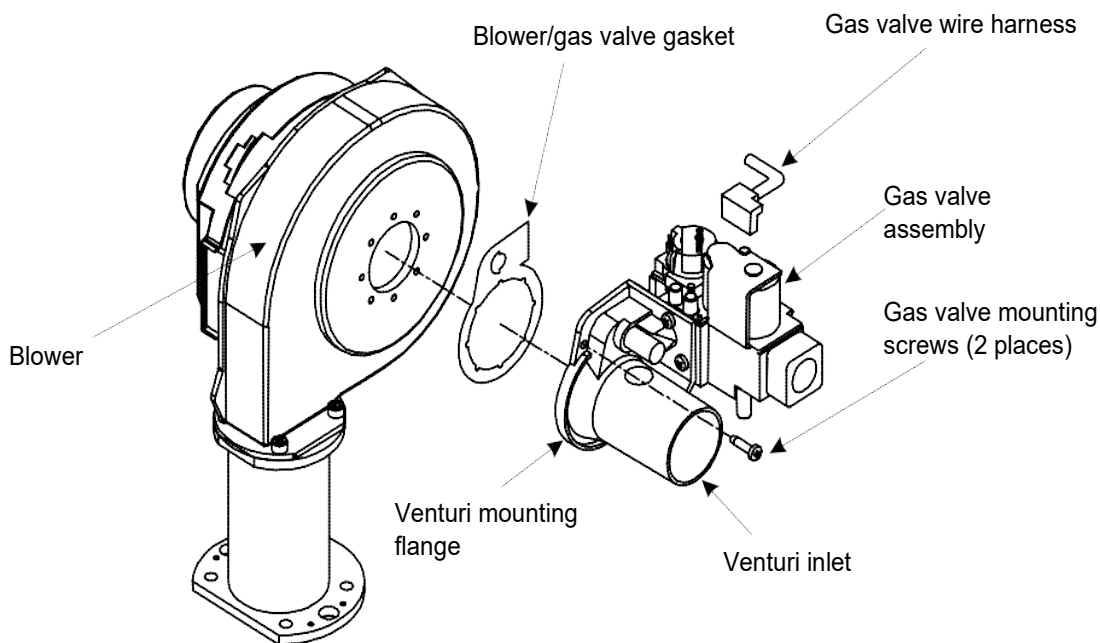

Service Procedure V

Blower Testing and Replacement

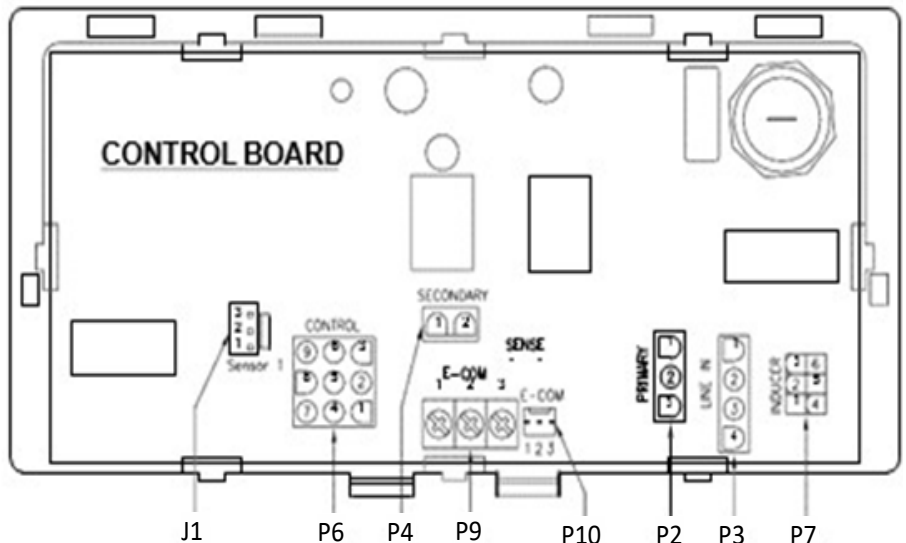
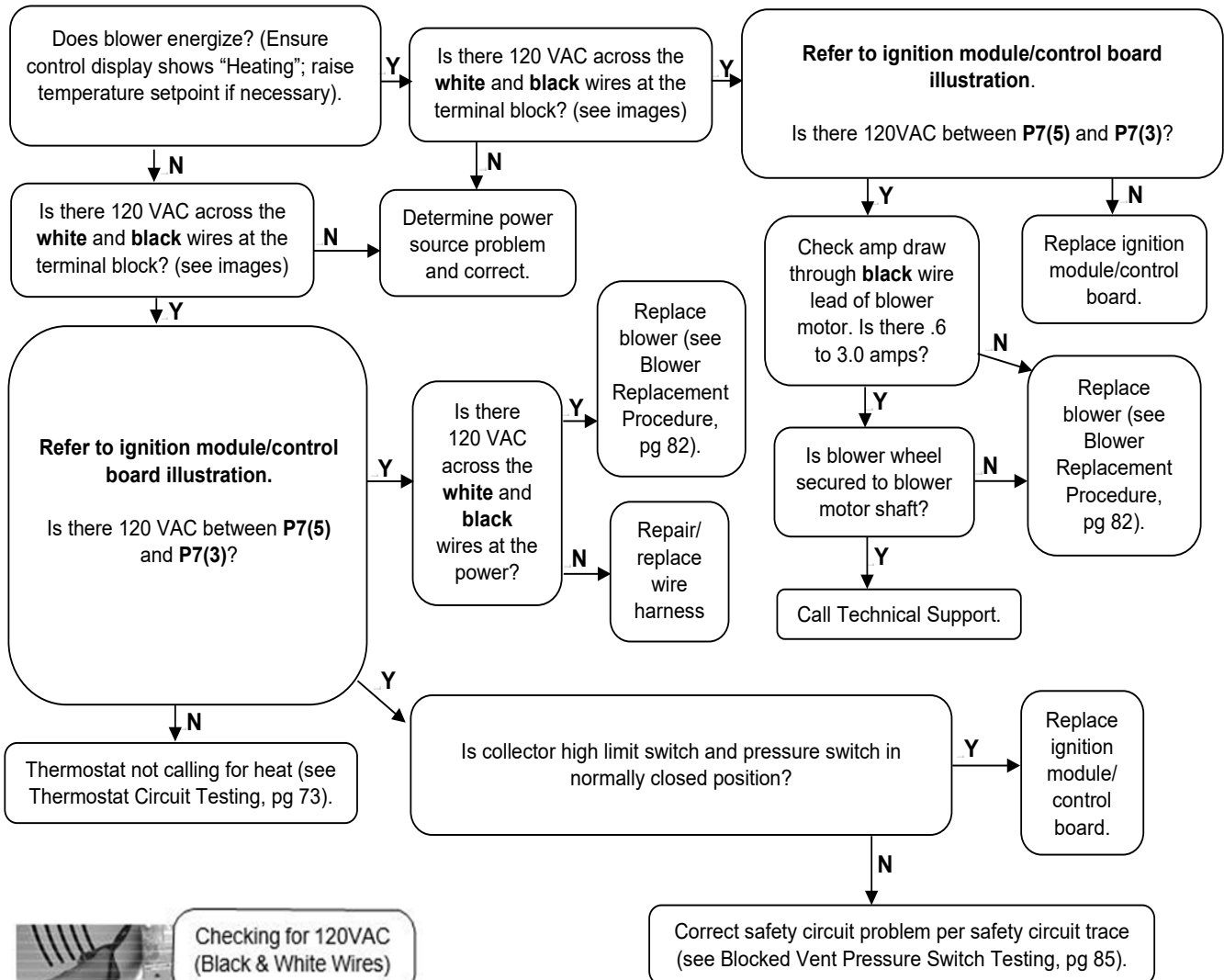

Service Procedure V

Blower Testing and Replacement (Continued)

Blower Replacement Procedure

⚠ WARNING

120 volt potential exposure. Isolate the appliance and reconfirm power is disconnected using a multi-meter.

1. Position main power switch to OFF.
2. Disconnect (unplug) water heater from 120 volt power source.
3. Turn OFF gas supply to water heater.
4. Unlatch and remove surround cover from top of heater.
5. Disconnect wire harness from blower.
6. Disconnect intake vent and gas supply from gas valve assembly.
7. Remove the two gas valve mounting screws (Torx bit) located on the venturi mounting flange.
8. Remove the four blower flange mounting screws (5/32 Allen wrench) and remove blower from transition flange.
9. Remove any residual gasket material from venturi mounting flange and transition flange.
10. Install new blower with new gasket provided. Secure blower in place using screws from step 8.
11. Reconnect gas valve assembly to blower with new gasket provided. Secure gas valve in place using screws from step 7.
11. Reconnect intake vent and gas line to gas valve assembly and check for gas leaks; repair any leaks found.
13. Reconnect wire harness to blower assembly. Restore 120 volt power supply and gas supply to water heater and confirm proper operation following the lighting instructions on the lighting instruction label or the lighting instructions located in the Installation and Operating Instruction Manual.
14. Replace the surround cover on the top of the water heater.

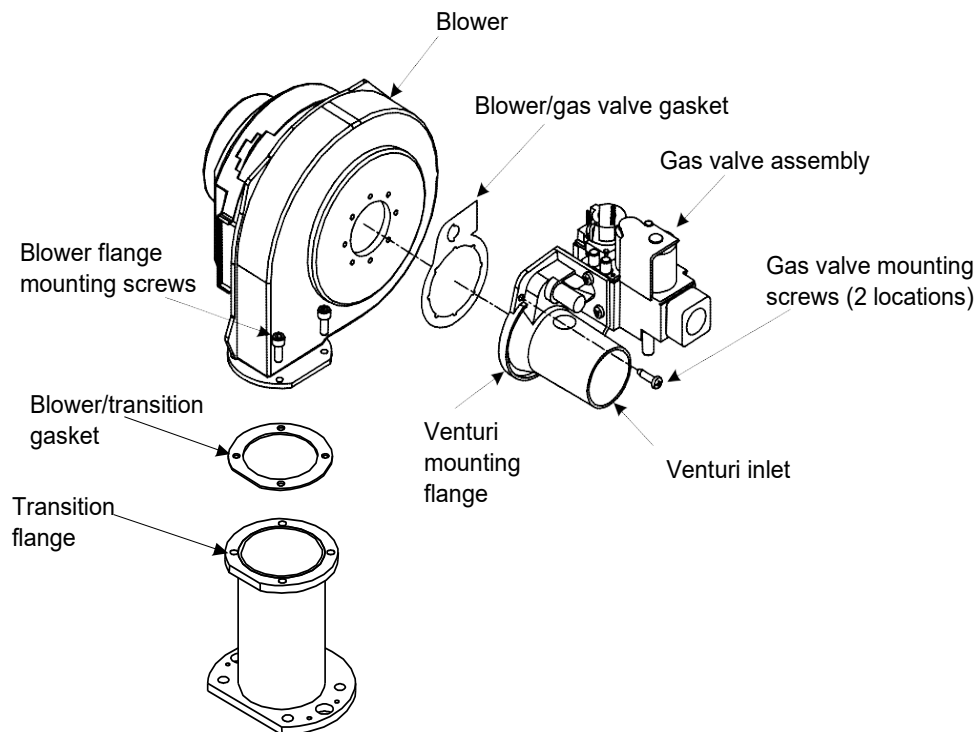

Service Procedure VI

Blocked Vent Pressure Switch Testing and Replacement

⚠ WARNING

120 volt potential exposure. Use caution making voltage checks to avoid personal injury.

⚠ WARNING

Make sure exhaust collector compartment is not overheating (350°F) before resetting vent safety switch. If there is evidence the collector compartment is overheating, call Technical Support.

Sequence of Operation: The blocked vent pressure switch monitors the pressure in the exhaust tube. The switch contacts are normally closed and will not open unless there is a blockage in the exhaust venting or terminal (snow, ice, debris). If the blocked vent pressure switch contacts open after the thermostat initiates the blower, the blower will remain on for up to 5 minutes waiting for the contacts to close. If the contacts remain open, the blower will stop, and error code 29 will display.

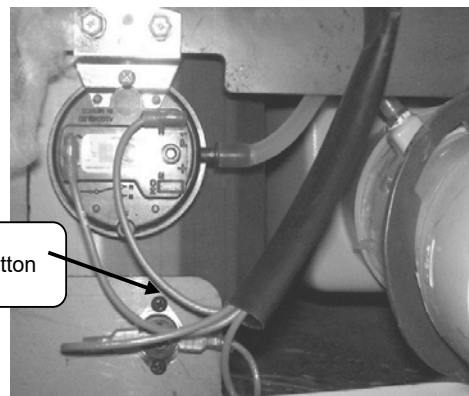
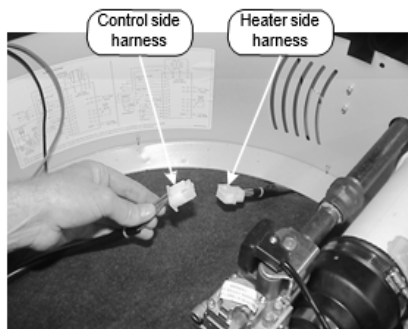
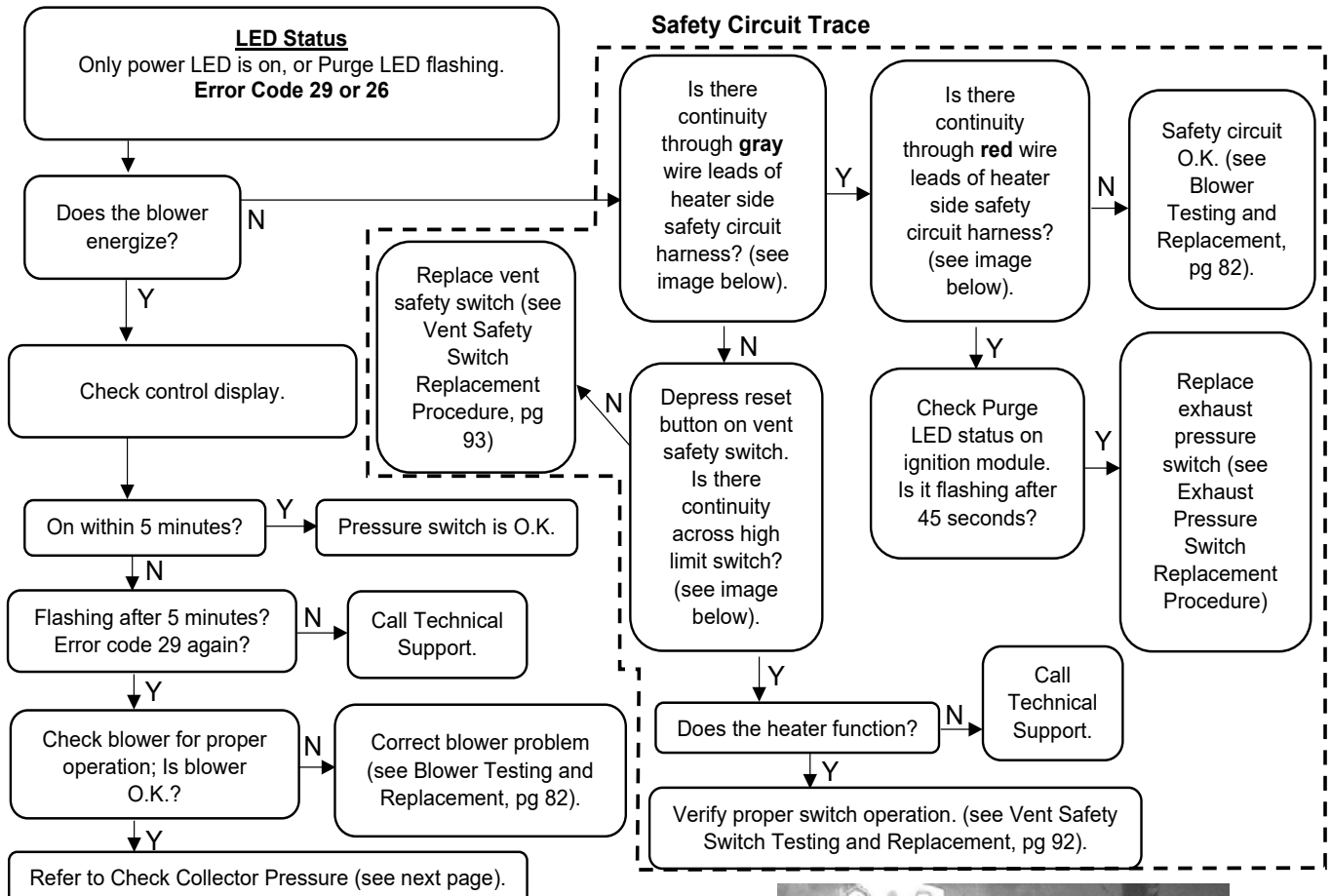

Service Procedure VI

Blocked Vent Pressure Switch Testing and Replacement (Continued)

Check Exhaust Tube Pressure

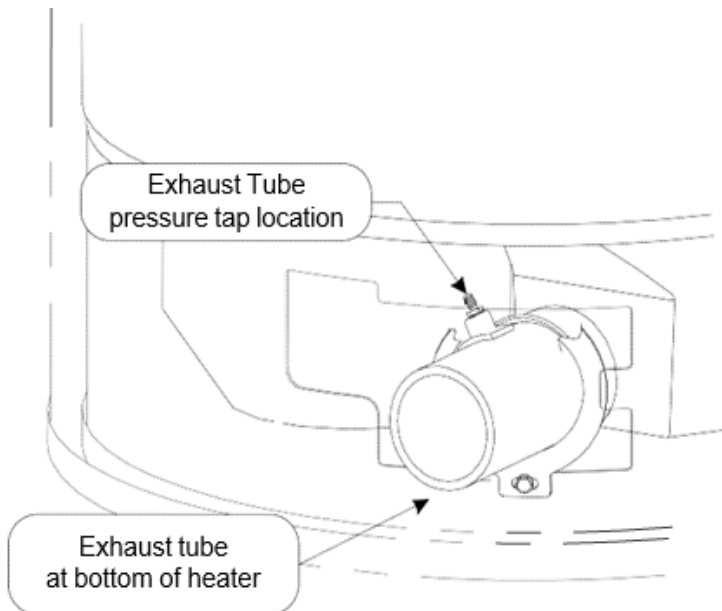
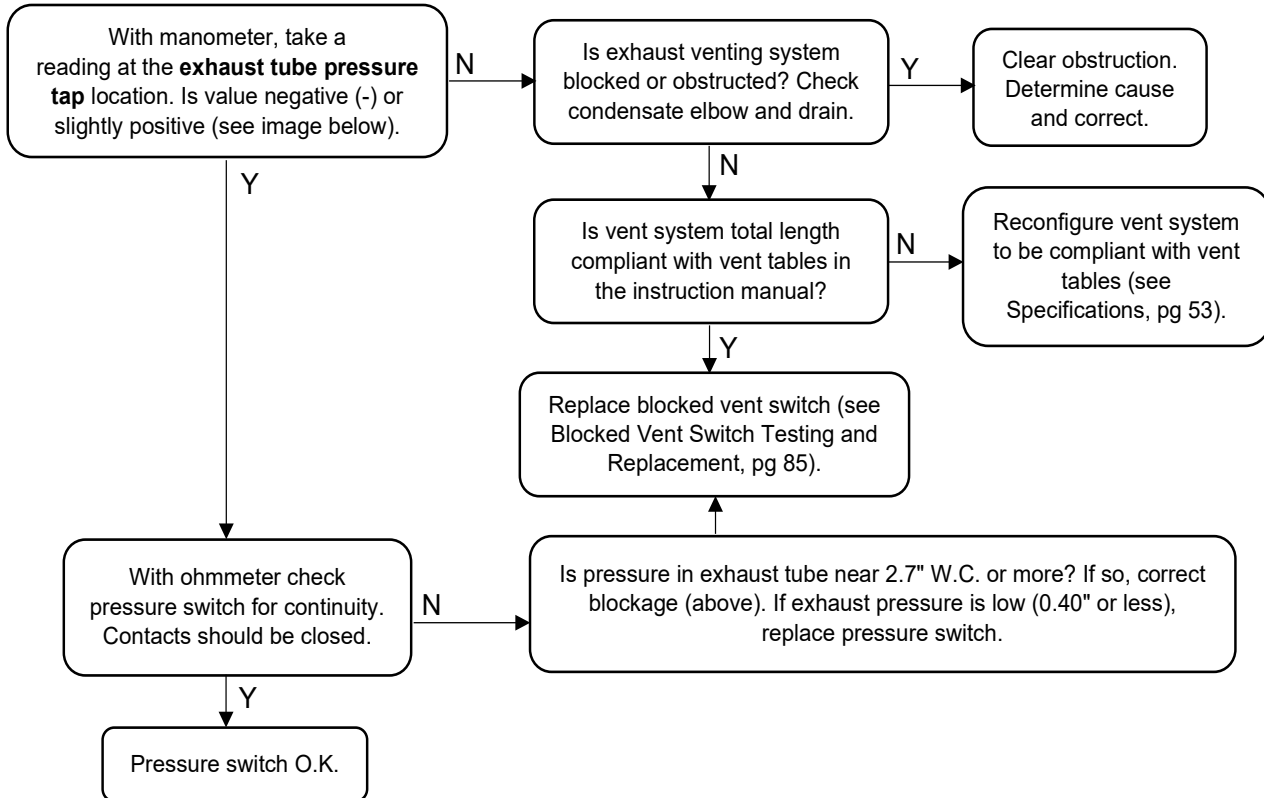

Service Procedure VI

Blocked Vent Pressure Switch Testing and Replacement (Continued)

Exhaust Pressure Switch Replacement Procedure

1. Position main power switch to "OFF" position.
2. Loosen adhesive backed rubber escutcheon from service panel access cover and slide escutcheon back along exhaust pipe to allow for removal of cover.
3. Remove screws from service panel access cover ($\frac{1}{4}$ " nut driver) and remove cover from heater (see images at right).
4. Disconnect silicone tubing and wire leads from pressure switch (see images at right).
5. Remove pressure switch mounting screws ($\frac{5}{16}$ " wrench) and remove pressure switch.
6. Assemble new pressure switch to heater using screws from Step 5.
7. Reconnect wire leads. **Note:** Wire leads are interchangeable with either terminal.
8. Reconnect silicone tubing to pressure switch as follows:
 - a. Exhaust pipe tubing connects to single tap located on switch.
9. Restore 120 volt power supply to water heater and confirm proper operation following the lighting instructions on the lighting instruction label or the lighting instructions located in the Installation and Operating Instruction Manual.
10. Reinstall service panel access cover and rubber escutcheon.

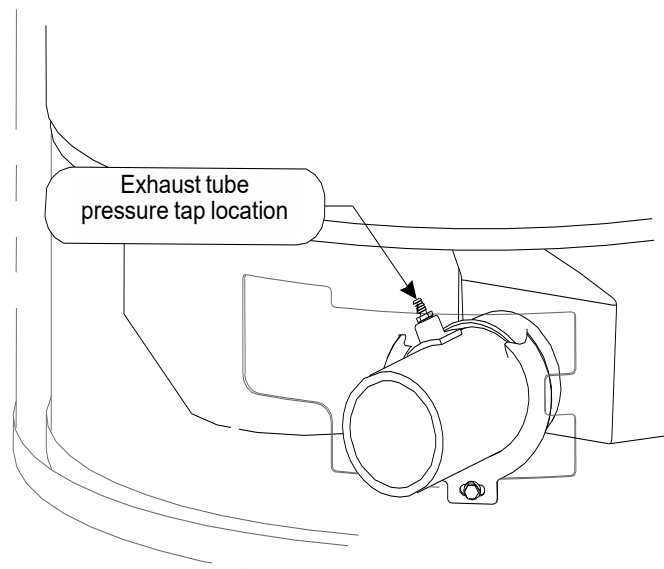
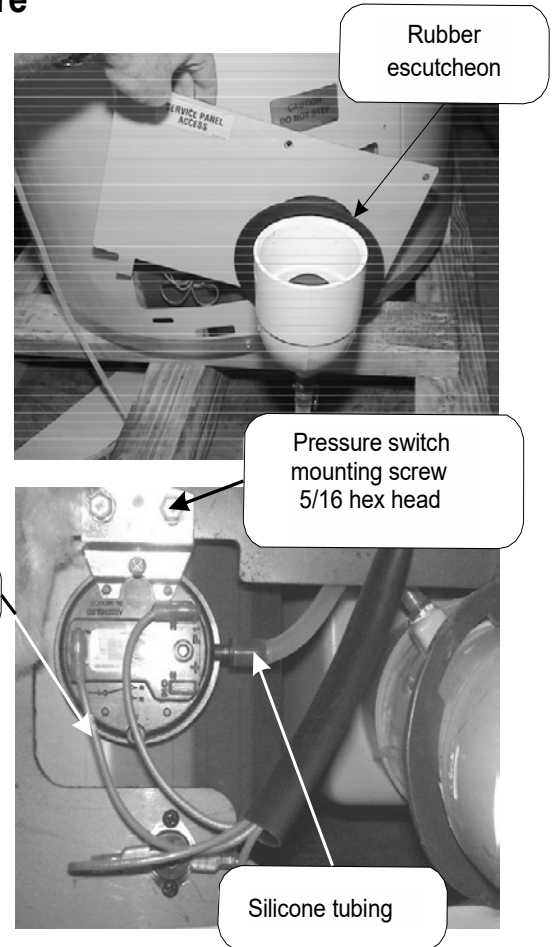

Service Procedure VII

Flame Sensor Testing and Replacement

⚠ WARNING
 120 volt potential exposure. Use caution making voltage checks to avoid personal injury. Flame sensor may be too hot to handle, take necessary precautions.

Flame Sensor Testing Procedure

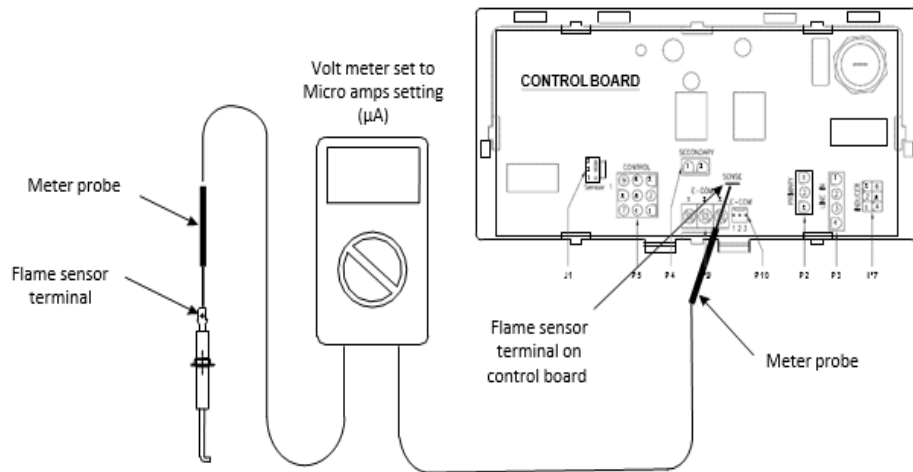
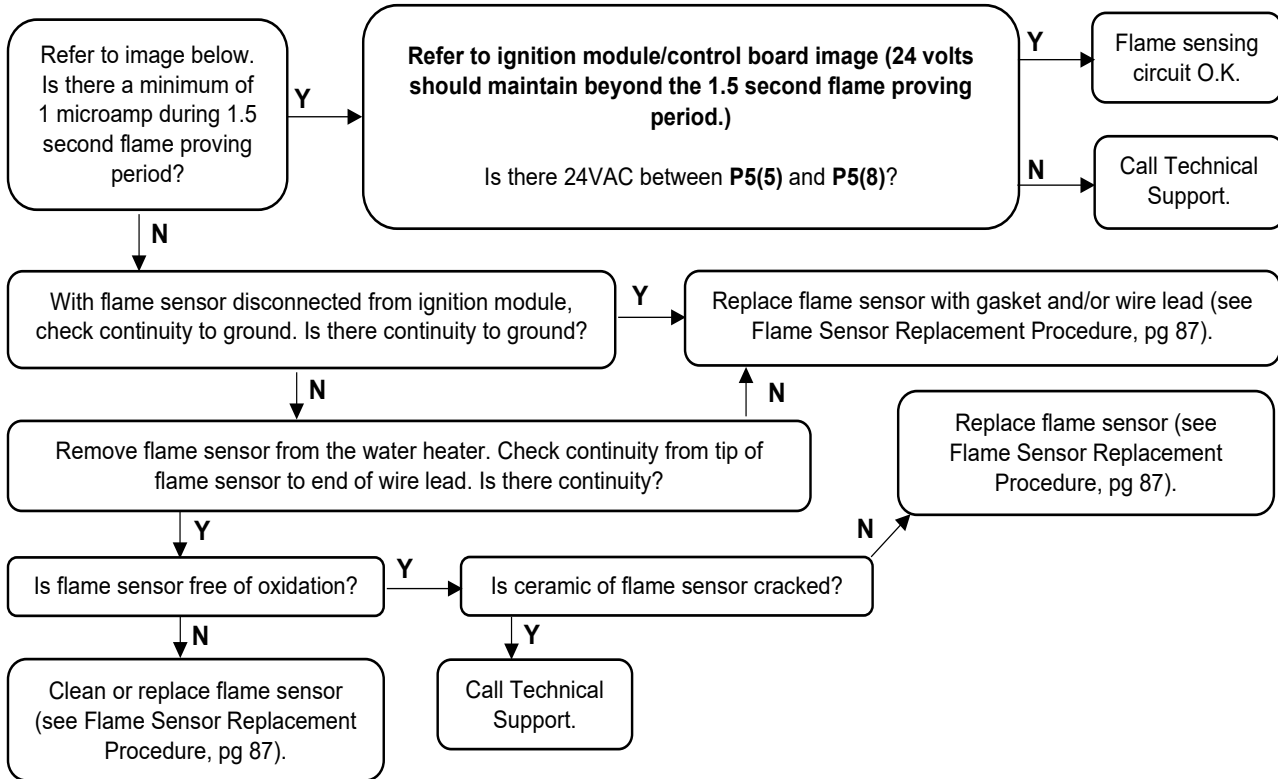

Service Procedure VII

Flame Sensor Testing and Replacement (Continued)

Flame Sensor Replacement Procedure

1. Position main power switch to OFF.
2. Disconnect (unplug) water heater from 120 volt power source.
3. Unlatch and remove the surround cover from the top of the water heater.
4. Fold back insulation in front of combustion assembly to expose flame sensor (see image at right).
5. Disconnect the wire lead from the flame sensor.
6. Remove the two sensor mounting screws (magnetic tip, long reach Phillips screwdriver) and remove flame sensor and gasket from the transition base flange.
7. Remove any residual gasket material from the transition base flange.
8. Install new flame sensor with new gasket provided using screws from step 6. Arrange the flame sensor with hook towards the burner.
9. Reconnect the flame sensor wire.
10. Fold insulation back into place. Be sure no wires are in contact with the burner flange.
11. Restore 120 volt power supply to water heater and confirm proper operation following the lighting instructions on the lighting instruction label or the lighting instructions located in the Installation and Operating Instruction Manual.
12. Replace the surround cover on the top of the water heater.

⚠ WARNING

120 volt potential exposure. Isolate the appliance and reconfirm power is disconnected using a multimeter.

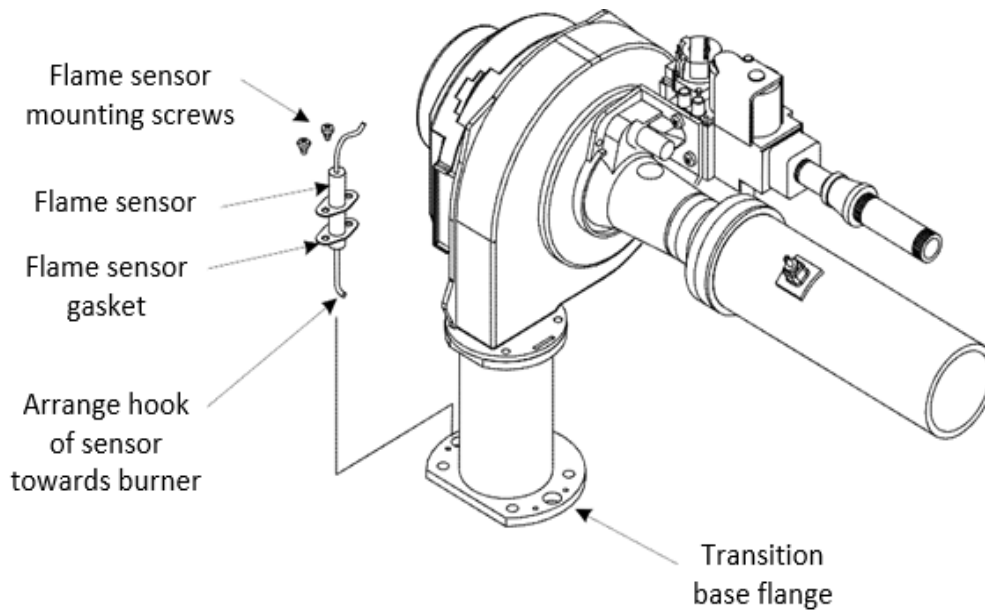
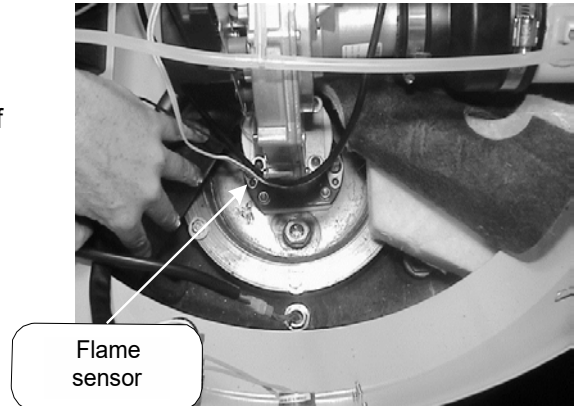

Service Procedure VII

Spark Rod Gap Adjustment and Replacement (Continued)

Spark Rod Gap Inspection and Adjustment

1. Remove combustion system as described in Combustion System Removal Procedure (pg 76).
2. Measure spark gap between the spark rod and burner tube. Acceptable spark gap is between 3/16" - 1/4" (see images below).
3. If spark gap is not between 3/16" - 1/4", the spark rod may be carefully bent by supporting the end near the ceramic insulator with pliers and bending the end near the burner tube with needle nose pliers (see image below).
4. Ensure and verify spark gap is between 3/16" - 1/4" after bending.
5. Reinstall the combustion system per Combustion System Replacement Procedure (pg 77) and check several ignitions to ensure the burner lights smoothly.

⚠ WARNING

Spark gap must be set to 3/16" to 1/4". Failure to set and verify proper spark gap may result in a delayed ignition resulting in damage to the water heater.

⚠ CAUTION

Use caution while performing these steps to prevent stressing or cracking the ceramic insulator.

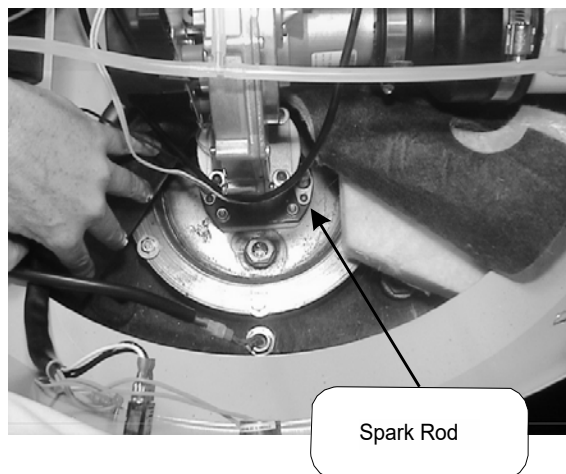
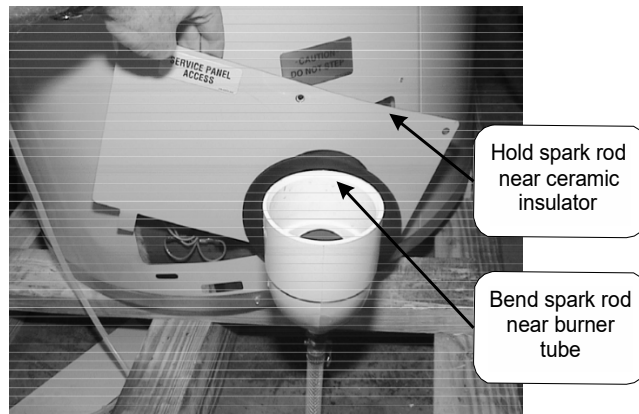
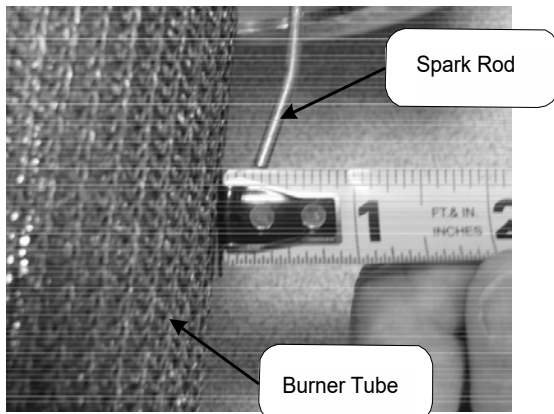

Service Procedure VIII

Spark Rod Gap Adjustment and Replacement (Continued)

Spark Rod Replacement Procedure

1. Position main power switch to OFF.
2. Disconnect (unplug) water heater from 120-volt power source.
3. Unlatch and remove the surround cover from the top of the water heater.
4. Fold back insulation in front of combustion assembly to expose spark rod (see image at right).
5. Disconnect the wire lead from the spark rod.
6. Remove the 2 mounting screws (magnetic tip, long reach Phillips screwdriver) and remove spark rod and gasket from the transition base flange.
7. Remove any residual gasket material from transition base flange.
8. Install new spark rod with new gasket provided using screws from step 6. Arrange spark rod with hook towards burner (off-center mounting hole towards the front of the water heater).
9. Remove combustion system following Combustion System Removal Procedure (pg 76) and verify spark gap following Spark Rod Gap Adjustment and Replacement (pg 88).
10. Reassemble combustion system following Combustion System Replacement Procedure (pg. 77).
11. Fold insulation back into place. Be sure no wires are in contact with burner flange.
12. Restore 120-volt power supply to water heater and confirm proper operation following the lighting instructions on the lighting instruction label or the lighting instructions located in the Installation and Operating Instruction Manual.
13. Replace the surround cover on the top of the water heater.

⚠ WARNING

120-volt potential exposure. Isolate the appliance and reconfirm power is disconnected using a multimeter.

⚠ CAUTION

If spark rod is replaced for any reason, the combustion system **MUST** be removed and the spark gap to the burner measured and adjusted properly.

⚠ WARNING

Spark gap must be set to 3/16" to 1/4". Failure to set and verify proper spark gap may result in a delayed ignition resulting in damage to the water heater.

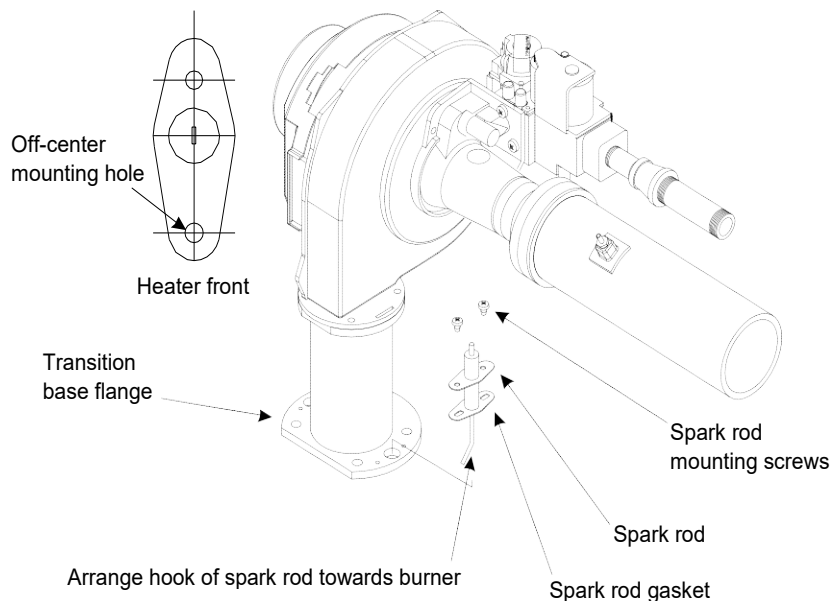
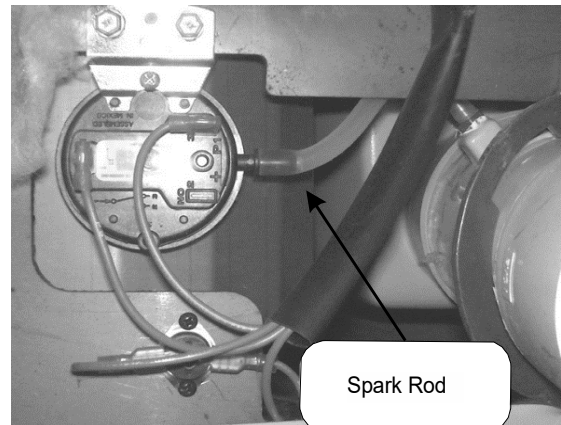

Service Procedure IX

Ignition Module/Control Board Replacement

Control Board Replacement (Integrated Control w/ Direct Spark Ignition)

⚠ WARNING

120-volt potential exposure. Isolate the appliance and reconfirm power is disconnected using a multimeter.

1. Position main power switch to OFF.
2. Disconnect (unplug) water heater from 120-volt power source.
3. Unlatch and remove surround cover from the top of the water heater.
4. Locate the control board.
5. Carefully disconnect all wire connections from the control board.
Note: It may be necessary to identify wires for proper reconnection.
6. Depress the plastic tabs on the blower side of the control board first.
7. Tilt the control panel and slide control hook tabs from slots in the control panel (see image below).
8. Replace the control board and all wire connections.
9. Restore 120-volt power supply to the water heater and confirm proper operation following the lighting instructions on the lighting instruction label or the lighting instructions located in the Installation and Operating Manual.
10. Replace the surround cover on the top of the water heater.

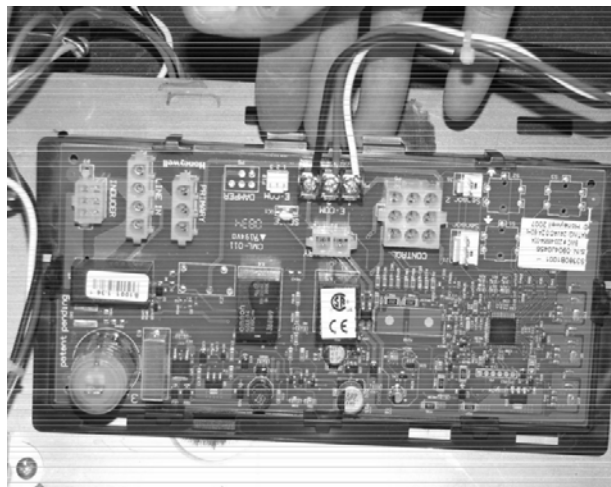
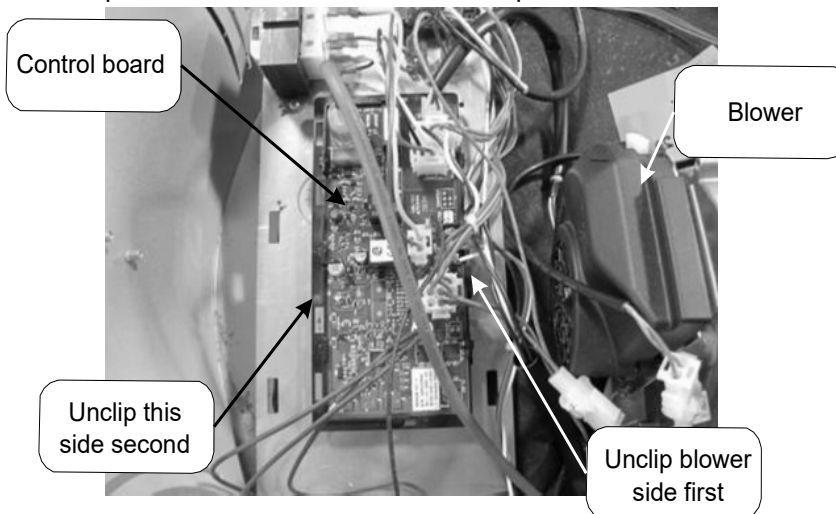

Service Procedure X

Transformer Replacement

Transformer Replacement Procedure

1. Position main power switch to OFF.
2. Disconnect (unplug) water heater from 120-volt power source.
3. Unlatch and remove the surround cover from the top of the water heater.
4. Disconnect primary leads (**black & white**) and secondary leads (**blue & yellow**) from the control board (connectors are different sizes to prevent interchanging).
5. Remove the 2 screws (short Phillips screwdriver) holding the transformer in place and remove transformer from control panel (see image at right).
6. Install new transformer and secure in place with screws from Step 5.
7. Reconnect primary and secondary wires to the board (controls are different sizes to prevent interchanging).
8. Restore 120-volt power supply to the water heater and confirm proper operation following the lighting instructions on the lighting instruction label or the lighting instructions located in the Installation and Operating Manual.
9. Replace the surround cover on the top of the water heater.

⚠ WARNING

120-volt potential exposure. Isolate the appliance and reconfirm power is disconnected using a multimeter.

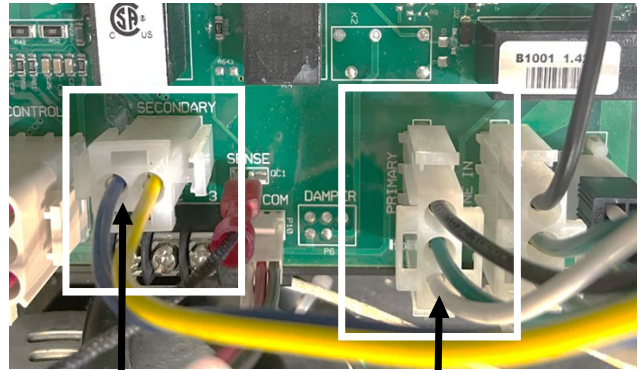

Secondary Lead Wires and connector

Primary Lead Wires and connector

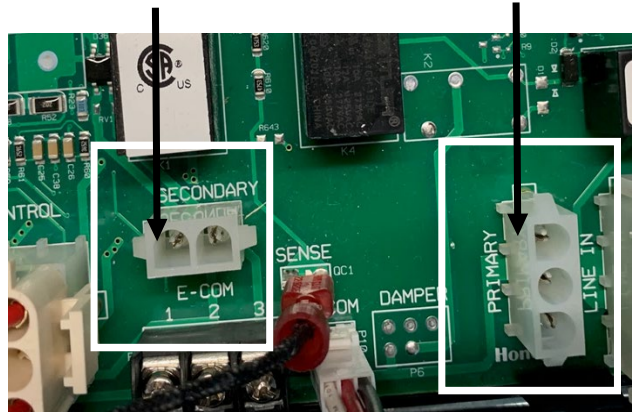

Remove Screws

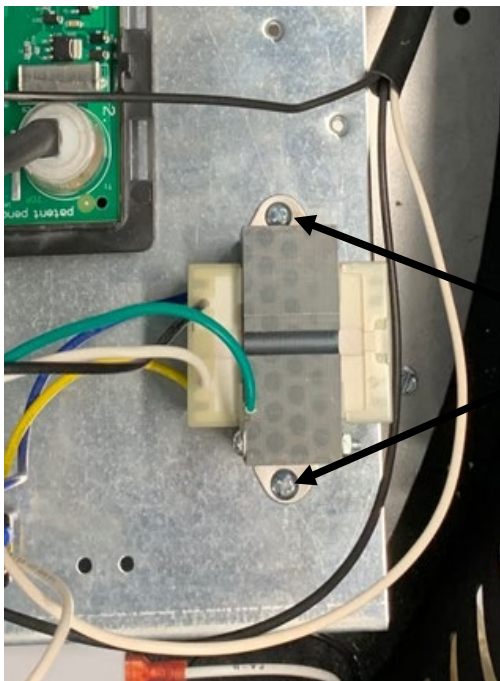

Service Procedure XI

Vent Safety Switch Testing and Replacement

⚠ WARNING

120-volt potential exposure. Isolate the appliance and reconfirm power is disconnected using a multimeter.

⚠ WARNING

Make sure the exhaust collector compartment is not overheating (350°F) before resetting vent safety switch. If there is evidence the collector compartment is overheating, call Technical Support.

Sequence of Operation

Error code 26 will display indicating an open circuit for the vent safety switch. Determine if temperature has reached 350°F before resetting switch and restoring operation. If evidence of extreme temperature is present, call Technical Support.

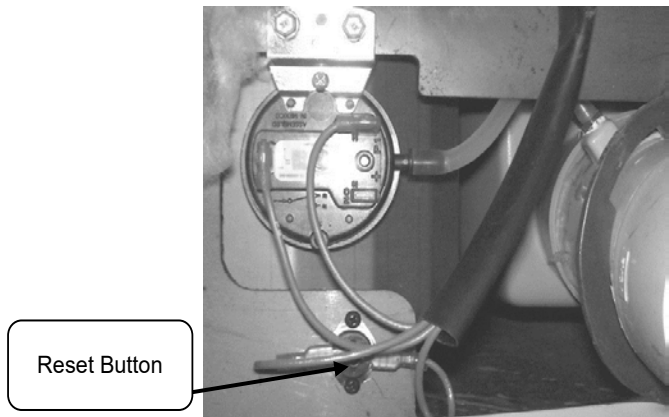
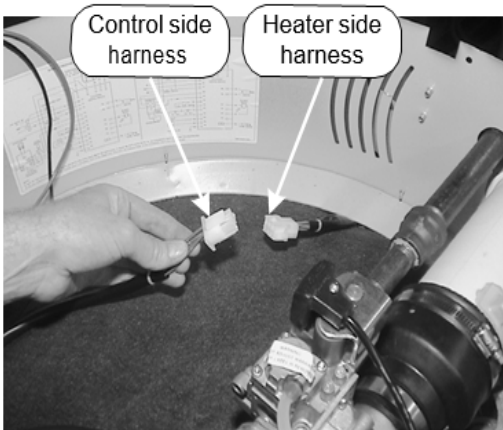
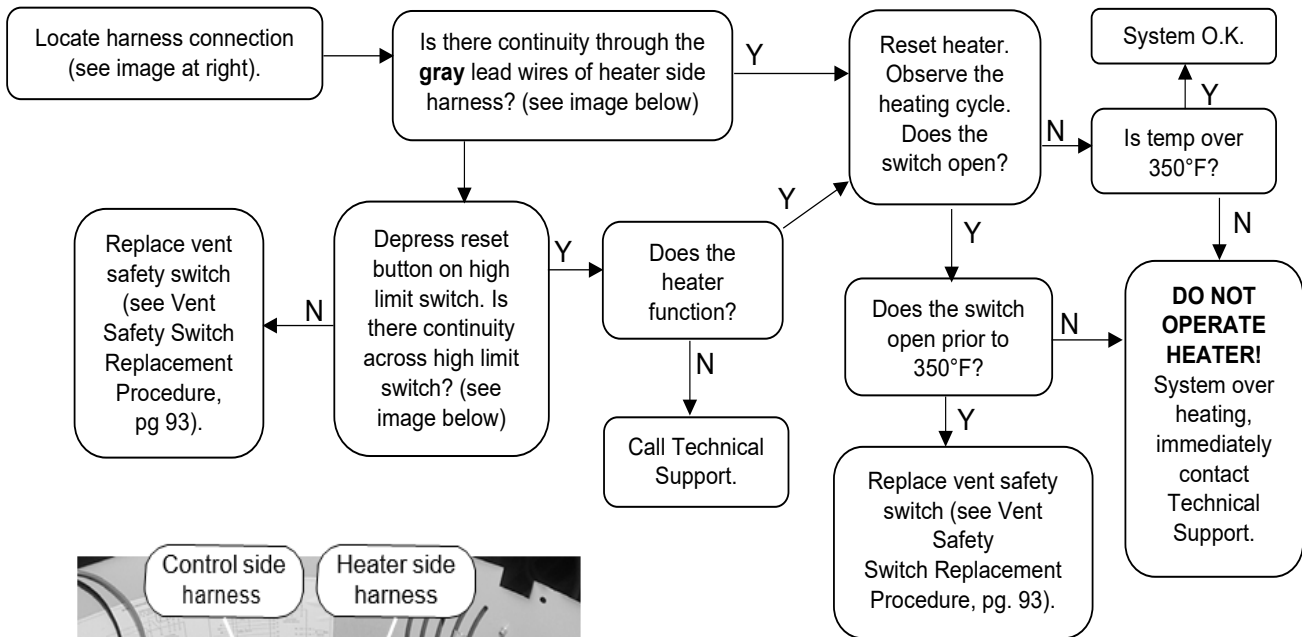

Service Procedure XI

Vent Safety Switch Testing and Replacement (Continued)

Vent Safety Switch Replacement Procedure

⚠ WARNING

120-volt potential exposure. Isolate the appliance and reconfirm power is disconnected using a multimeter.

1. Position main power switch to OFF.
2. Loosen the adhesive backed rubber escutcheon from the service panel access cover and slide the escutcheon back along the exhaust pipe to allow for removal of cover (see photos below).
3. Remove the screws from service panel access cover ($\frac{1}{4}$ " nut driver) and remove the cover from the water heater (see images below)
4. Disconnect the wire leads from the vent safety switch (see image below).
5. Remove the 2 switch mounting screws (Phillips screwdriver) and nuts ($\frac{5}{16}$ wrench) and remove the switch from the water heater.
6. Install new switch using the screws from step 5.
7. Reconnect the wire leads.
Note: Wire leads are interchangeable with either switch terminal.
8. Restore 120-volt power supply to water heater and confirm proper operation following the lighting instructions on the lighting instruction label or the lighting instruction located in the Installation and Operating Instruction Manual.
9. Reinstall the service panel access cover and the rubber escutcheon.

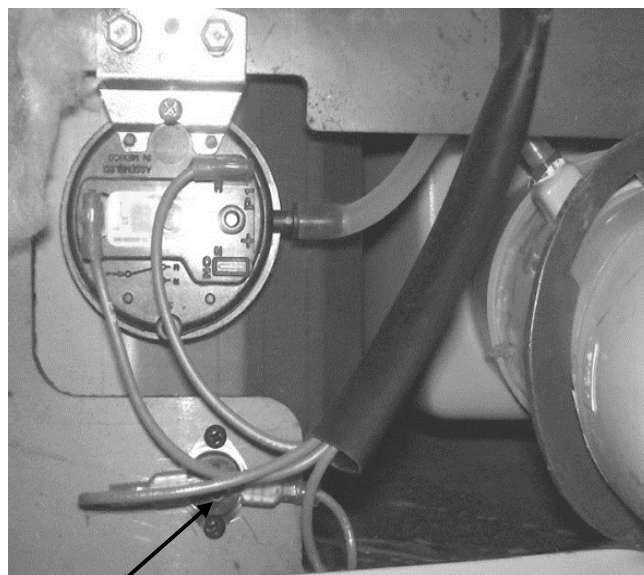

Service Procedure XII

Flue Baffle Inspection and Replacement

⚠ WARNING

Heater components may be HOT when performing the following steps in this procedure. Take necessary precaution to prevent personal injury.

Flue Baffle Inspection and Replacement

1. Disassemble heater per Disassembly Procedure for Access to Anodes and Flue Baffles.
2. Remove flue baffles from heater using pliers (8 two inch (2") baffles & 2 four inch (4") baffles).
3. Visually inspect flue baffles. Flue baffles should show signs of oxidation, this is normal. If the oxidation has deteriorated any portion of the flue baffle, replacement is recommended. If any restrictors are missing, replacement is recommended.
4. Upon completion of inspection or subsequent replacement, reinstall flue baffles into heater.
5. Reinstall collector cover per Collector Cover Installation Procedure.
6. Reinstall collector insulation and control panel, reconnect control panel wire harnesses.
7. Restore 120 volts to water heater and verify proper heater operation following the instructions on the lighting instruction label or the lighting instruction located in the Installation and Operating Instruction Manual.
8. Replace the surround cover on the top of the water heater.

Collector Cover Installation Procedure

1. Remove old silicone from top surface of collector flange and collector cover.
2. Apply ¼" bead of Ultra Copper Silicone around entire collector flange surface. Allow caulk to "cure" for 10 minutes.
3. Carefully reinstall collector cover, tighten screws evenly.
4. Allow a minimum of 6 hours before putting heater back in service.

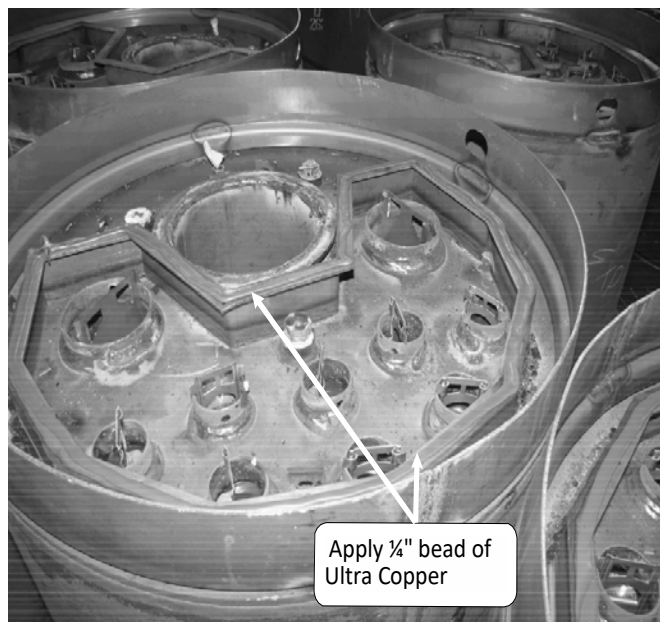

Service Procedure XIII

Powered Anode Replacement

⚠ WARNING!

Water heater components may be HOT when performing the following steps in this procedure. Take necessary precaution to prevent personal injury.

The powered anode control module is located on the vertical side of the control panel inside the surround panel. The control has a LED indicator light to show the status of operation. When the tank is filled with water and the power supply is on the water heater, the light should have a steady green glow to indicate that protection current is flowing and operating normally. If the indicator light is not glowing, the power supply to the water heater or powered anode system is disconnected.

1. Check the power supply or wire connections to the powered anode control.
2. Indicator light diagnostic codes:
 - a. If the control is flashing red, then there is a malfunction with the powered anode system. Make sure there are no bare spots in the wire insulation to the powered anode rods.
3. Check all electrical connections. The powered anode rods are insulated from the water heater tank in the bushing.
 - a. With an ohmmeter, check continuity between the powered anode terminal and the bushing. There should not be continuity. If there is continuity, replace the powered anode assembly.

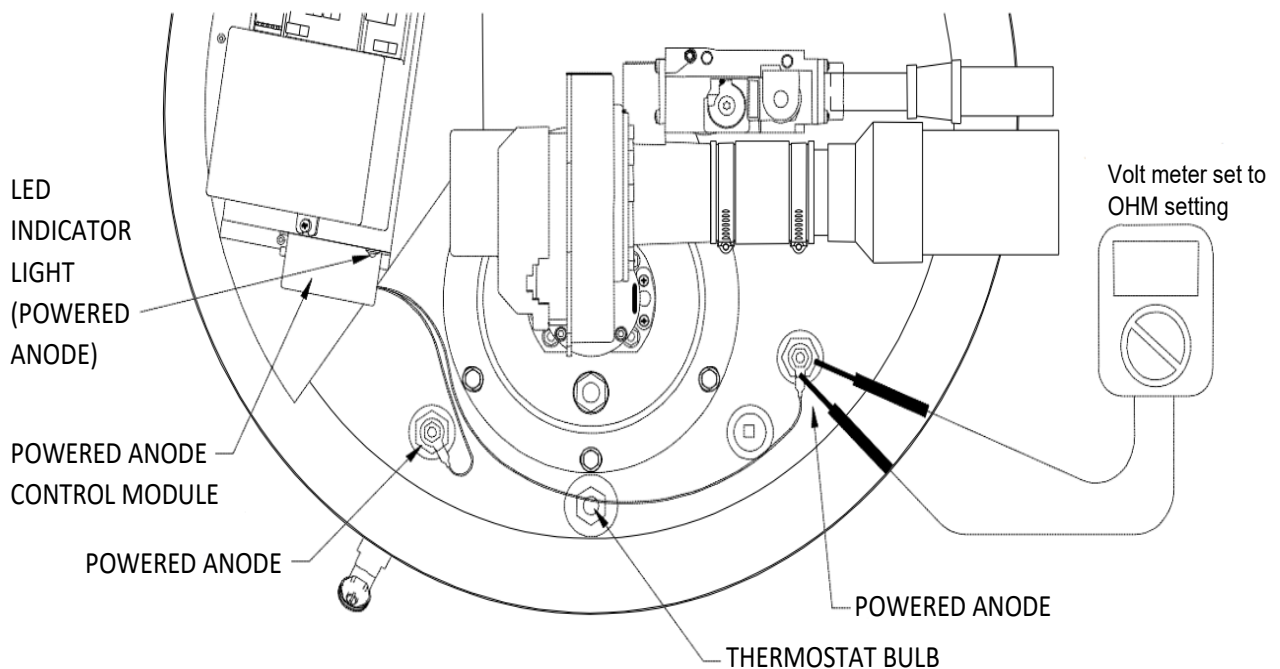



United States

Sales 800-523-2931

Technical Support 800-334-3393

Email techserv@bradfordwhite.com

Warranty 800-531-2111

Email warranty@bradfordwhite.com

Service Parts 800-538-2020

Email parts@bradfordwhite.com

Canada

Sales & Technical Support 866-690-0961 905-203-0600

Fax 905-636-0666

Warranty bwccwarranty@bradfordwhite.com

Technical Support bwccotech@bradfordwhite.com

Service Parts orders@bradfordwhitecanada.com

Orders ca.orders@bradfordwhite.com

For U.S. and Canada field service,
contact your professional installer or
local Bradford White sales representative.

International

General Contact international@bradfordwhite.com