



BRADFORD WHITE[®]
W A T E R H E A T E R S

**Ultra Low NOx
Residential D Series**

Gas Water Heaters



SERVICE MANUAL

**Troubleshooting Guide
and Instructions for Service**

(To be performed ONLY by
qualified service providers)

**Models Covered
by This Manual:**

URG1D30T*N
URG1D40S*N
URG1D40T*N
URG1D50T*N
URG2D40S*N
URG2D50S*N
(* Denotes Warranty Years)



As required by the state of California Proposition 65.

The Bradford White

Ultra Low NO_x

Residential D Series

Gas Water Heaters

Table of Contents

	<u>Page</u>	<u>D Service Procedure</u>
Introduction.....	4	---
How to Use This Manual.....	5	---
Tools Required for Service.....	5	---
Specifications.....	6	---
Control Timings.....	7	---
Sequence of Operation.....	8	---
Troubleshooting.....	11	---
Burner Inspection, Cleaning & Replacement.....	14	D-I
Pilot Testing, Cleaning & Replacement.....	17	D-II
Damper Removal & Installation.....	18	D-III
Gas Control Testing & Replacement.....	19	D-IV
Flammable Vapor Device Testing and Replacement.....	22	D-V
Diptube Inspection & Replacement.....	23	D-VI
Anode Inspection & Replacement.....	24	D-VII
Flue Baffle Inspection & Replacement.....	25	D-VIII
Inner Door Removal, Inspection & Replacement.....	27	D-IX
115 VAC Circuit Trace.....	30	D-X
Damper Relay Installation.....	31	D-XI
Chamber Sensor Testing.....	34	D-XII
Resettable Thermal Switch, Inspection & Replacement.....	35	D-XIII
ScreenLok [®] Flame Arrestor Cleaning.....	37	---
Glossary of Terms.....	38	---
Parts List.....	39	---

ULN Res. D Series

WARNING: If the information in these instructions is not followed exactly, a fire or explosion may result causing property damage, personal injury, or death.

FOR YOUR SAFETY

Do not store or use gasoline or other flammable, combustible, or corrosive vapors and liquids in the vicinity of this or any other appliance.

WHAT TO DO IF YOU SMELL GAS!

- Do not try to light any appliance.
- Do not touch any electrical switch; do not use any phone in your building.
- Immediately call your gas supplier from a neighbor's phone. Follow the gas supplier's instructions.
- If you cannot reach your gas supplier, call the fire department.

Installation and service must be performed by a qualified installer, service agency or the gas supplier.

⚠ DANGER

Do not store or use gasoline or other flammable, combustible, or corrosive vapors and liquids in the vicinity of this or any other appliance.

IMPORTANT

Before proceeding, please inspect the water heater and its components for possible damage. DO NOT install any water heater with damaged components. If damage is evident then please contact the supplier where the water heater was purchased or the manufacturer listed on the rating plate for replacement parts.

⚠ WARNING

Water heaters are heat producing appliances. To avoid damage or injury, do not store materials against the water heater or vent-air intake system. Use proper care to avoid unnecessary contact (especially by children) with the water heater and vent-air intake components. **UNDER NO CIRCUMSTANCES MUST FLAMMABLE MATERIALS, SUCH AS GASOLINE OR PAINT THINNER BE USED OR STORED IN THE VICINITY OF THIS WATER HEATER, VENT-AIR INTAKE SYSTEM OR IN ANY LOCATION FROM WHICH FUMES COULD REACH THE WATER HEATER OR VENT-AIR INTAKE SYSTEM**

⚠ CAUTION

If sweat fittings are to be used **DO NOT** apply heat to the nipples on top of the water heater. Sweat the tubing to the adapter before fitting the adapter to the water connections. It is imperative that heat is not applied to the nipples containing a plastic liner.

⚠ WARNING

Hydrogen gas can be produced in an operating water heater that has not had water drawn from the tank for a long period of time (generally two weeks or more). Hydrogen gas is extremely flammable. To prevent the possibility of injury under these conditions, we recommend the hot water faucet to be open for several minutes at the kitchen sink before you use any electrical appliance which is connected to the hot water system. If hydrogen is present, there will be an unusual sound such as air escaping through the pipes as hot water begins to flow. Do not smoke or have open flame near the faucet at the time it is open.

⚠ WARNING

DO NOT ATTEMPT TO LIGHT ANY GAS APPLIANCE IF YOU ARE NOT CERTAIN OF THE FOLLOWING:

- Liquefied petroleum gases/propane gas and natural gas have an odorant added by the gas supplier that aids in the detection of the gas.
- Most people recognize this odor as a "sulfur" or "rotten egg" smell.
- Other conditions, such as "odorant fade" can cause the odorant to diminish in intensity, or "fade", and not be as readily detectable.
- If you have a diminished sense of smell, or are in any way unsure of the presence of gas, immediately contact your gas supplier from a neighbor's telephone.

Gas detectors are available. Contact your gas supplier, or plumbing professional, for more information.

⚠ WARNING

FAILURE TO INSTALL AND MAINTAIN A NEW, LISTED 3/4" X 3/4" TEMPERATURE AND PRESSURE RELIEF VALVE WILL RELEASE THE MANUFACTURER FROM ANY CLAIM THAT MIGHT RESULT FROM EXCESSIVE TEMPERATURE AND PRESSURES.

⚠ CAUTION

Turn off or disconnect the electrical power supply to the water heater before servicing. Label all wires prior to disconnection when servicing controls. Wiring errors can cause improper and dangerous operation. Verify proper operation after servicing.

The Bradford White

Introduction

The new Bradford White Ultra Low NOx Residential Flue Damper water heaters are designed to provide reliable performance with enhanced standard features. New design features include reliable spark-to-pilot ignition system, enhanced diagnostics, simplified servicing, significantly quiet operation, and the Bradford White Defender Safety System.

Spark-to-Pilot Ignition System – employing the spark-to-pilot ignition system promotes reliable and consistent pilot and main burner ignitions to provide hot water on demand.

Integrated Immersion Thermal Well/Gas Control with LED – was developed for ease of troubleshooting by providing simple diagnostic codes to pinpoint an installation or component performance issue.

Rugged Wiring Connections – receptacle type connections promote error free wiring.

The gas control maintains water temperature, ignition sequence, and regulates gas flow. If a situation outside of the normal operating parameters exists, the gas control diagnostic LED will flash a code to positively identify an operational issue.

Please read the service manual completely before attempting service on this new series of damper models.

How the Safety System Works

During normal operation, most air for combustion is drawn into the water heater through the openings in the jacket door. This air travels into the burner venturi, mixing with the gas jet. This air is then mixed with gas inside the burner and drawn to the burner screen and is efficiently combusted producing Ultra Low NOx emissions. Additional air is drawn through the openings in the jacket. This air travels down and around the combustion chamber and enters through holes in the bottom of the corrosion-resistant combustion chamber. The air then travels up through the oriented flame arrestor plate louvers, where the velocity of the air is increased and its direction altered. The air then mixes in a normal manner with the combustion products from the burner.

In the case where trace amounts of flammable vapors are present in the air flowing into the combustion chamber and burner venturi, the vapors are harmlessly ignited by the burner/pilot flame. If flammable vapors are in sufficient quantity to prevent normal combustion, the burner and pilot flames are designed to shut down.

Should the flammable vapors continue to the burner, the flame arrestor plate and burner screen prevent the flames from traveling backwards and igniting vapors outside of the combustion chamber. The gas control utilizes a flammable vapor sensor to detect the presence of flammable vapors and shut down if the vapors achieve a certain level. It is intended for this manual to be used by qualified service personnel for the primary purpose of troubleshooting and repair of the Bradford White D Series water heaters. Understanding the sequence of operation section of this manual will contribute greatly to troubleshooting the water heater.

The ICON System WV4472 electronic gas control will display status codes in the event of abnormal operation. Status codes are listed in the troubleshooting chart beginning on page 11 of this service manual. The troubleshooting chart will also indicate the probable cause for the status code and direct the service professional to a service procedure to properly diagnose the abnormal operation.

Contact the Bradford White technical support group immediately if diagnosis cannot be made using the methods described in this service manual.

It is intended for this manual to be used by a qualified service personnel for the primary purpose of the troubleshooting and repairing of the Bradford White "D" Series water heaters. Understanding the sequence of operation section of this manual will contribute greatly to troubleshooting the water heater.

The ICON System WV4472 electronic gas control will display status codes in the event of abnormal operation. Status codes are listed in the troubleshooting chart beginning on page 11 of this service manual. The troubleshooting chart will also indicate the probable cause for the status code and direct the service professional to a service procedure to properly diagnose the abnormal operation.

Contact the Bradford White technical support group immediately if diagnosis cannot be made using the methods described in this service manual.

Tools Required for Service

Manometer:	A liquid "U" tube type or a digital (magnahelic) type can be used. This device is used to measure gas and/or air pressure and vacuum.
Multi-Meter:	A digital type is strongly recommended. This device is used to measure electrical values. The meter you select must have the capability to measure volts AC, volts DC, Amps, micro-amps and ohms.
Electronic Probes:	In some cases, standard multi-meter probes will damage or simply not be effective to obtain certain voltage and ohm readings. It will be necessary to have special electronic "pin" type multi-meter probes. These probes are available at most electronic wholesale outlets.
Thermometer:	Used to measure water temperature. An accurate thermometer is recommended.
Water Pressure Gage:	Used to measure water supply pressure. Also used to determine tank pressure by adapting to the drain valve of the heater.
Various Hand Tools:	Pipe wrench, channel locks, open end wrenches (3/8", 7/16", 1/2"), 12" crescent wrench, allen wrench set, screw drivers (common & Phillip's), 1/4" nut driver, pliers (common & needle nose), socket set, side cutters, wire cutters, wire strippers, wire crimpers, torpedo level, small shop vac, step ladder, flashlight and 5 gallon pail.

ULN Res. D Series

Specifications

Power supply	Dedicated 115 VAC, 60 Hz, 15A
Gas Supply Pipe	Minimum 1/2" NPT (schedule 40 black iron pipe recommended)
Approved Gas Type	Natural Gas unit must match gas type supplied
Gas Pressure	6.0" w.c. min., 14.0" w.c. maximum
Venting System	Single or Double Wall Metal Vent Pipe
Minimum Clearance for Servicing	18" from top, 24" from front, 4" sides and rear
Water Supply Pressure	150 PSI maximum allowable working pressure. Check local codes for supply pressure
Gas Control ECO Limit	Residential 188°F (87°C)
Temperature Setpoint Range	60°F (16°C) to 160°F (71°C) (approximate temperatures)

ULN Res. D Series

Control Timings

Control Timings

<u>Ignition State</u>	<u>Timing</u>
Adjust Damper Position and Verify (Open Position)	15 Seconds
Trial for Ignition	90 Seconds
Flame Stabilization Period	3 Seconds
Re-adjust Damper Position and Verify	15 Seconds
Flame Failure Response Time	1.5 Seconds (2 second maximum; 1 second minimum.)
Adjust Damper Position and Verify (Closed Position)	15 Seconds
Damper Blade Position Fault (failed open/close)	Retry after 2 minutes
Soft Lockout	Retry after 5 minutes
ECO Limit Lockout	Indefinite (see page 27)
Verify Resistive Delay	Retry after 2 minutes (repeats 5 times)
Simulated Resistive Load Lockout	Indefinite (cycle power to restart)
Hardware Status Lockout	Indefinite (self clears if fault clears for at least 15 seconds)

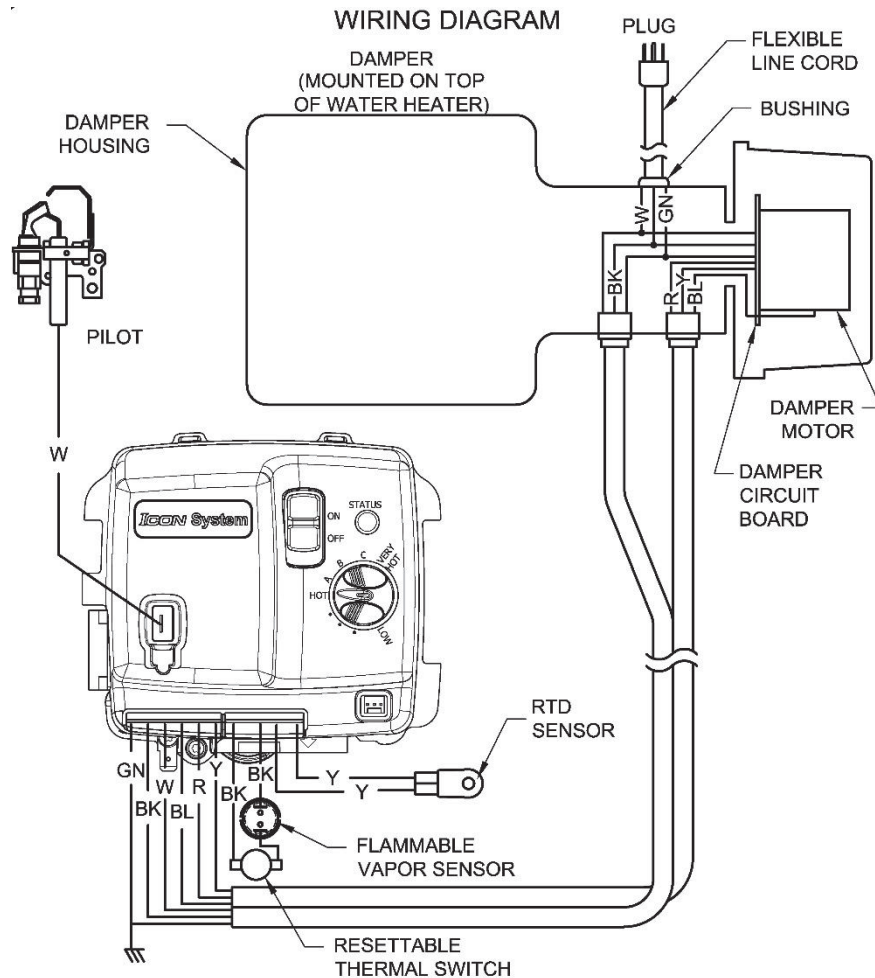

Power Up Sequence

1. Start Up.
Upon power up, the control runs a safe-start check with a typical start-up delay of 5 seconds.
2. Flammable Vapor.
The gas control verifies that the Flammable Vapor Sensor is in the proper operating range prior to energizing any components. If the sensor is within the proper range, the gas control resumes normal operation. If the Flammable Vapor Sensor is out of range, the gas control LED immediately flashes 7 times with a 3 second pause.

Normal Heating Sequence

When the phrase “Damper Open” is used, this means that the damper blade is in the vertical position (open). Alternatively, “Damper Closed” means that the damper blade is in the horizontal position (closed). This must not be confused with the phrase “Damper Circuit Open,” as this means that the damper blade is in the horizontal position. “Damper Circuit Closed” means that the damper blade is in the vertical position, and the water heater can proceed to an ignition trial.

1. Thermostat calls for heat.
Prior to energizing damper, gas control verifies the damper safety circuit to ensure it is in the correct state. If the safety circuit is closed, the gas control LED flashes 2 times with a 3 second pause. The gas control waits 2 minutes. Then, the damper is powered closed. This cycle repeats until the safety circuit opens.
2. Damper Powered Open.
3. Damper Safety Circuit Check:
If the damper safety circuit does not close within 30 seconds, the gas control LED flashes 3 times with 3 second pause. The damper is powered open for a maximum of 30 seconds every 2 minutes trying to close the damper safety circuit. This cycle repeats as long as there is a call for heat.
4. Damper hold period (15 seconds).
5. Trial for pilot ignition (90 seconds): The gas control lights the pilot by activating the spark igniter and gas flow to the pilot burner. If flame is not sensed within 90 seconds, the spark igniter and gas flow are deactivated. The damper will remain open, and the gas control LED flashes 6 times with a 3 second pause.
6. Main burner ignition: After the pilot flame is sensed, the gas control activates the main valve for main burner ignition. The gas control will ignore flame signals for 3 seconds to allow for the main burner to stabilize

Normal Heating Sequence (cont.)

7. Steady state operation.

During steady state operation, the control monitors:

Thermostat Temperature Sensor-when setpoint temperature is satisfied, gas valve is shut down and damper is powered closed. The gas control LED flashes a short flash once every 4 seconds (idle) status code.

Damper Position-if the damper position is altered during a call for heat, the pilot and main valves are shutdown. The damper is powered open attempting to close the damper safety circuit. The gas control LED flashes 3 times with a 3 second pause.

Flame Sensor-if flame is lost, pilot & main valves are shut down. The damper is powered open. The gas control attempts to re-light the pilot 4 times. If unsuccessful, the damper is closed, and the gas control proceeds to a 5 minute lockout. The gas control re-attempts to light the pilot starting at normal heating sequence #2.

8. Thermostat satisfies. (Gas Control LED flashing once every 4 seconds).

9. Burner off.

10. Damper Powered Closed (15 seconds).

Abnormal Operation

1. Flammable Vapor Sensor Fault:

- a. **If the Resistance is Greater than 70,000 Ohms**-the gas control immediately turns off all outputs. The gas control waits and monitors resistance for 30 seconds. If the resistance is greater than 65,000 ohms after 30 seconds, the gas control proceeds to verify resistive delay for 2 minutes and flashes 7 times, then 1 time with a 3 second pause. This process is repeated 5 times until the control either returns to normal operation or proceeds to flammable vapor lockout.
- b. **If the Resistance is Below 3000 Ohms**-The gas control immediately turns off all outputs and proceeds to flash 8 times, then 1 time with a 3 second pause. The status self clears if the resistance returns to normal range for at least 15 seconds.

2. Temperature Sensor Fault:

- a. **Temperature Sensor Open Circuit**-The gas control immediately turns off all outputs and proceeds to flash 8 times then, 3 times with 3 second pause. The status self clears if the fault clears for at least 15 seconds.

Abnormal Operation (cont.)

- b. **Thermal Well Sensor Not Reading the Same Temperature Within $\pm 5.5^{\circ}\text{F}$**
–The gas control immediately turns off all outputs and proceeds to flash 8 times, then 3 times twice with 3 second pauses. The status self clears if the fault clears for at least 15 seconds.
- c. **Water Temperature in Excess of ECO (Energy Cut Out) Limit** -The gas control immediately turns off pilot & main valves and proceeds to flash 4 times with a 3 second pause. To reset the gas control, rotate the setpoint knob to the minimum setting for at least 6 seconds before returning to desired temperature setting.
- 3. Damper Safety Circuit Fault:
 - a. **Damper Failed to Open**-The gas control proceeds to flash 3 times with a 3 second pause. The gas control waits 5 minutes, and then tries to open the damper again.
 - b. **Damper Failed to Close**-the gas control proceeds to flash 2 times with a 3 second pause. The gas control waits 5 minutes, and then tries to open the damper again.
- 4. Trial for Ignition Fault:
 - a. **Damper Jostled During Trial**-The gas control stops the trial for ignition. The gas control proceeds to flash 3 times with a 3 second pause. The gas control waits 5 minutes, and then tries to open the damper again.
 - b. **Flame Not Sensed**-The gas control energizes the spark igniter attempting to light the pilot and prove flame. If flame is not sensed within 90 seconds, the spark igniter turns off, the pilot valve is closed. The gas control LED flashes 6 times, then 1 time with a 3 second pause. The gas control waits 5 minutes before repeating the ignition sequence.
- 5. Flame sensing fault:
 - a. **Flame Lost During Run**-The gas control turns off pilot and main valves. The gas control increments the recycle count, if the recycle count has not reached its limit (4), another trial for ignition begins. If the recycle count has been reached, the gas control LED flashes 6 times, then 3 times with a 3 second pause. The gas control waits 5 minutes before repeating the ignition sequence.
 - b. **Flame Sensed Out of Sequence**-the gas control only looks for pilot flame when the damper is in the open position. If flame is present when the pilot valve is not open, the gas control proceeds to wait for flame loss and flashes 5 times with 3 second pause. This continues until flame is lost. Once the flame signal is lost, the control flashes 6 times then, 4 times with 3 second pause. The control waits 5 minutes before repeating the ignition sequence.

ULN Res. D Series

Troubleshooting

Observe green LED indicator on electronic gas control. Status flash codes are displayed with a three second pause before repeating. Check and repair the system as noted in the troubleshooting table below.

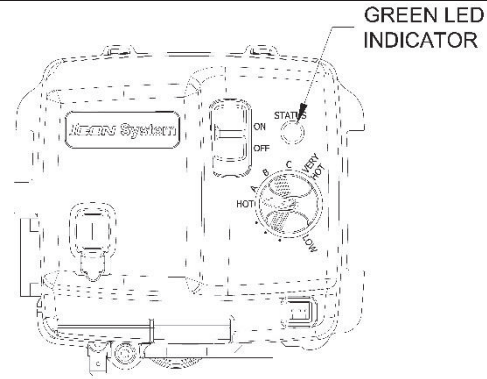

<u>LED Status</u>	<u>Control Status</u>	<u>Probable Cause</u>	<u>Service Procedure</u>
None, control LED not on or flashing	No electrical power	Control power switch in "OFF" position. Supply voltage interrupted.	Turn power on.
One short flash, once every two seconds	Stand-by mode, Waiting for call for heat (no fault).	Temperature demand is satisfied.	Normal operation. Adjust thermostat to temp level.
"Heartbeat" alternates bright/dim	Thermostat calling for heat (no fault).	Tank temperature below setpoint of thermostat.	Normal operation. Adjust thermostat to temp level.
Short flash once per second	Weak pilot signal on last call for heat.	<ol style="list-style-type: none"> 1. Unstable pilot. 2. Pilot tube blocked or restricted. 3. Oxidation build up on pilot electrode. 4. Wire damage to pilot assembly or bad connection at gas valve. 	<ol style="list-style-type: none"> 1. See burner inspection on Page 16. 2-4. See Pilot Inspection, Testing and Replacement on page 16.
Two flash, three second pause	Damper test circuit not working	<ol style="list-style-type: none"> 1. Damper not in proper position or malfunctioning-stuck in open position. 2. Obstructed venting. 3. Faulty damper. 	<ol style="list-style-type: none"> 1. Verify cord sets are fully plugged in 2. Verify switch on damper is in "Automatic" position. 3. Replace damper, see page 17.
Three flash, three second pause	Damper test circuit not working.	<ol style="list-style-type: none"> 1. Damper not in proper position or malfunctioning-not reaching full open position. 2. Obstructed venting. 3. Faulty damper. 	<ol style="list-style-type: none"> 1. Verify cord sets are fully plugged in 2. Verify switch on damper is in "Automatic" position. 3. Replace damper, see page 17.
Four flash, three second pause	Excessive tank temperature. System must be reset.	<ol style="list-style-type: none"> 1. Temperature sensor out of calibration. 2. Faulty gas control. 	Replace gas control, page 21.
Five flash, three second pause	Undesired-false pilot flame present.	<ol style="list-style-type: none"> 1. Pilot valve stuck in open position. 	Replace gas control, page 21.

ULN Res. D Series

Troubleshooting

LED Status	Control Status	Probable Cause	Service Procedure
Six-one flash, three second pause	Failed to light pilot. System auto resets.	<ol style="list-style-type: none"> 1. Unstable pilot. 2. Pilot tube blocked or restricted. 3. Oxidation build up on pilot electrode. 4. Wire damage to pilot assembly or bad connection at gas valve. 	<ol style="list-style-type: none"> 1. See Burner Inspection on page 14. 2. See Pilot Inspection, Testing and Replacement on page 16.
Six-two flash, three second pause	Damper test circuit not working properly during burner operation, system auto resets after (5) minutes.	<ol style="list-style-type: none"> 1. Damper not in proper position or malfunctioning-damper moved from full open position during run cycle. 2. Obstructed venting. 3. Faulty damper. 4. Damper jostled during run cycle. 	Page 17.
Six-three flash, three second pause	Pilot flame extinguished. System auto resets.	<ol style="list-style-type: none"> 1. Unstable pilot. 2. Pilot tubing kinked or blocked. 3. Oxidation build-up on pilot electrode. 4. Wire damage to pilot assembly or bad connection at gas control. 5. Insufficient combustion air. 6. Insufficient gas pressure. 	<ol style="list-style-type: none"> 1-4. Page 16. 5-6. Refer to Installation & Operation Manual.
Six-four flash, three second pause	Undesired-false pilot flame sensed. System auto resets.	Pilot valve stuck in open position.	Replace gas control, Page 21.
Seven flash, three second pause	Flammable vapor sensor or resettable thermal switch fault detected.	<ol style="list-style-type: none"> 1. Flammable vapor present 2. Flammable vapor sensor exposed to excessive moisture 3. Flammable vapor sensor exposed to extreme ambient temperature 4. Resettable thermal switch open 	<ol style="list-style-type: none"> 1-3. Flammable sensor testing, Page 22. 4. Resettable thermal switch testing, Page 33.
Eight-one flash, three second pause	Flammable vapor sensor out of specification.	Flammable vapor sensor out of specification.	Page 21.
Eight-two flash, three second pause	Temperature sensor fault.	<ol style="list-style-type: none"> 1. Damage to temperature sensor wire. 2. Temperature sensor resistance out of range. 	Replace gas control, Page 21.
Eight-three flash, three second pause	Gas control electronics fault detected.	<ol style="list-style-type: none"> 1. Control needs to be reset. 2. Control is wet or physically damaged. 	<ol style="list-style-type: none"> 1. Interrupt power supply 2. Replace gas control, page 21.
Eight-four flash, three second pause	Gas valve fault detected.	<ol style="list-style-type: none"> 1. Control needs to be reset. 2. Control is wet or physically damaged. 	<ol style="list-style-type: none"> 1. Interrupt power supply 2. Replace gas control, page 21.

ULN Res. D Series

Troubleshooting

<u>LED Status</u>	<u>Control Status</u>	<u>Probable Cause</u>	<u>Service Procedure</u>
Nine-One flash, three second pause	Insufficient combustion air detected.	Insufficient combustion air	Page 37.
Nine-two flash, three second pause	Chamber temperature sensor out of specification	<ol style="list-style-type: none">1. Chamber sensor out of calibration.2. Possible short.	Test Chamber door sensor on page 34

ULN Res. D Series

SERVICE PROCEDURE D-I
Burner Operation Inspection,
Cleaning and Replacement

Burner Inspection

At periodic intervals (every 6 months) a visual inspection should be made of the pilot and main burner for proper operation and to assure no debris is accumulating.

Pilot flame should be stable, some causes for an unstable pilot flame are:

- a) Water heater vent is less than the allowable vent length.
- b) Gas pressure is out of specification.
- c) Pilot flame not fully engulfing spark/flame sensor.

Main burner should light smoothly from pilot and burn with a blue flame with a minimum of yellow tips.

Main burner must be free from any debris accumulation that may affect burner operation (see burner cleaning procedure on page 15).

ULN Res. D Series

SERVICE PROCEDURE D-1
Burner Operation Inspection,
Cleaning and Replacement

Burner Cleaning

- Step 1. Position the gas control power switch to the "OFF" position and unplug the heater from the wall outlet.
- Step 2. Turn off gas supply to the water heater.
- Step 3. Remove outer jacket door.
- Step 4. Disconnect pilot tube ($\frac{7}{16}$ " wrench) and feedline ($\frac{3}{4}$ " wrench) from gas control.
- Step 5. Disconnect igniter/flame sensor wire, damper wire harness and FV wire harness from the gas control.
- Step 6. Remove the (4) $\frac{1}{4}$ " hex drive screws holding the right side inner door in place.
- Step 7. Remove the (3) $\frac{1}{4}$ " hex drive screws holding the left side burner door in place.
- Step 8. Remove burner assembly from combustion chamber.

IGNITER/FLAME
SENSE WIRE

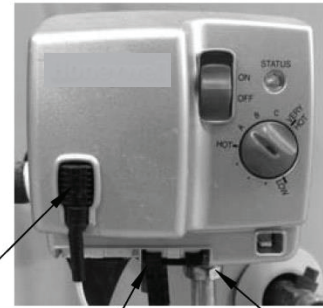

PILOT
TUBING NUT

FEEDLINE
NUT

RIGHT SIDE
INNER DOOR

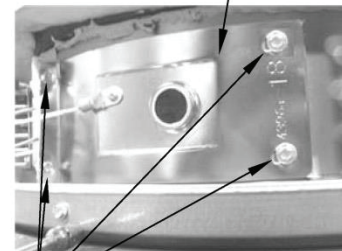

(4) $\frac{1}{4}$ " HEX DRIVE
SCREWS

LEFT SIDE
INNER DOOR

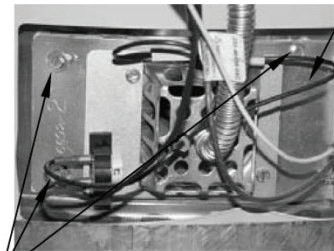

(3) $\frac{1}{4}$ " HEX
DRIVE
SCREWS

BURNER
ASSEMBLY

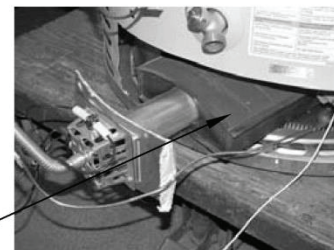

ULN Res. D Series

SERVICE PROCEDURE D-1
Burner Operation Inspection,
Cleaning and Replacement

Burner Cleaning (cont.)

Step 9. Remove manifold mount from burner inner door by removing (2) 1/4" hex drive screws.

(2) 1/4" HEX
DRIVE
SCREWS

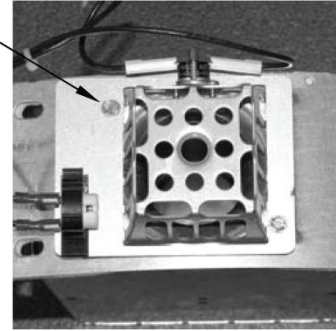

Step 10. Use a stiff brush, compressed air and/or a vacuum to remove any debris build up from the manifold mount.

Step 11. Thoroughly inspect burner surface area and burner port area and remove any loose debris using compressed air and/or a vacuum.

BURNER
SCREEN

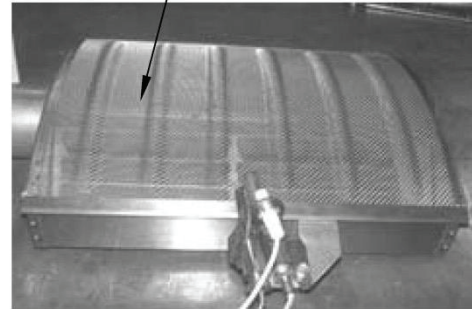

Step 12. Thoroughly inspect burner screen and burner venturi and remove any loose debris accumulation. Inspect burner screen for any openings larger than the normal screen openings.

BURNER
VENTURI

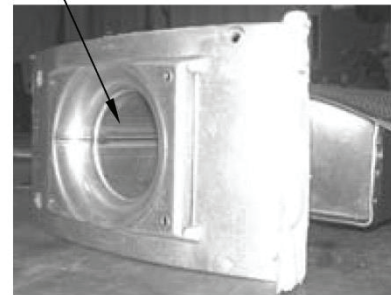

Step 13. Remove main burner orifice from feedline (1/2" wrench) inspect orifice, clean or replace if necessary.

Step 14. Reassemble burner and reinstall inner door with gasket into water heater per service procedure IX on page 26. Restore gas supply and check for gas leaks.

MANIFOLD
MOUNT

FEEDLINE

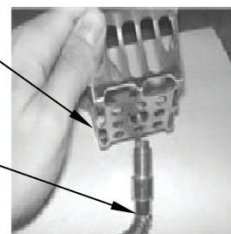

Step 15. To resume operation, follow the instruction located on the lighting instruction label or the lighting instruction located in the installation and operation manual.

MAIN BURNER
ORIFICE

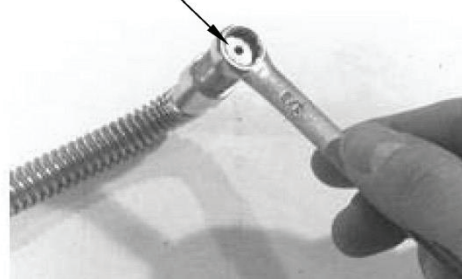

Pilot Testing and Replacement

Step 1. Visually inspect igniter/flame sense electrode for oxidation build up. Carefully clean any oxidation using very fine emery cloth.

Step 2. Remove pilot assembly from the burner assembly (1/4" nut driver).

Step 3. Visually inspect igniter/flame sense wire for damage. Replace pilot if damage is found.

Step 4. With a multi-meter set to ohms setting, check continuity through igniter/flame sense wire. Replace pilot if no continuity.

Step 5. Visually inspect igniter/flame sense electrode for deterioration. Replace pilot as necessary. Electrode should not be in contact with pilot hood, if so, carefully adjust electrode to a gap of distance of $\frac{3}{32}$ " (.09) from pilot hood.

Step 6. Visually inspect pilot tubing for kinks or cracks. If damage is found, replace pilot.

Step 7. Inspect pilot tubing and pilot orifice for blockage:

- Remove ferrule nut from bottom of pilot assembly ($\frac{7}{16}$ " wrench).
- Remove pilot tube and pilot orifice.
- Inspect pilot tubing and pilot orifice for blockage. Clean or replace pilot as necessary.

Step 8. Reassemble pilot and install on burner. Reinstall inner door assemblies to water heater per service procedure IX on page 26.

Step 9. Restore gas supply and check for gas leaks.

Step 10. To resume operation, follow the instruction located on the lighting instruction label or the lighting instruction located in the installation and operation manual.

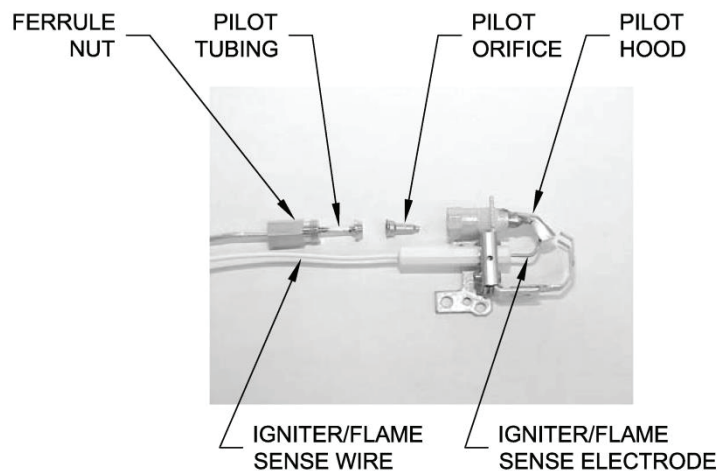
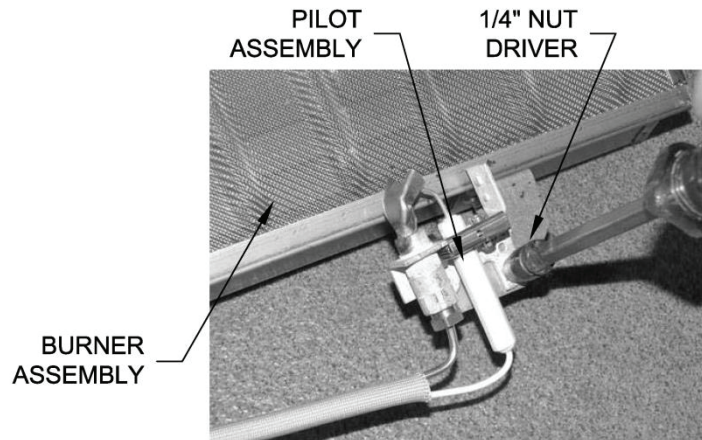

ULN Res. D Series

SERVICE PROCEDURE D-III
Damper
Removal and Replacement

Damper Removal & Installation

- Step 1. Position the power switch on the gas control to the "OFF" position and unplug the water heater from the wall outlet.
- Step 2. Disconnect the vent system from the draft hood that is mounted on top of the damper
- Step 3. Remove the draft hood from the damper and retain it for use on the new damper.

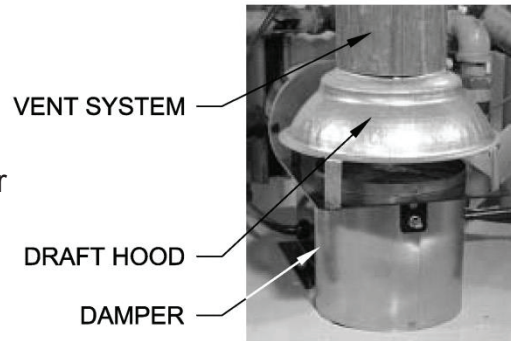

- Step 4. Disconnect the cord sets from the damper.

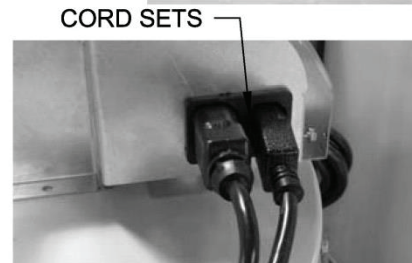

- Step 5. Remove the two mounting screws from the damper using a 1/4" nut driver and retain for later.
- Step 6. Carefully remove the damper from the top of the water heater.
- Step 7. Clean any debris from the jacket head of the water heater.
- Step 8. Set the new damper in place using the water heater tank flue and the screw holes in the jacket head.
- Step 9. Secure the damper in place using the screws from step 5.

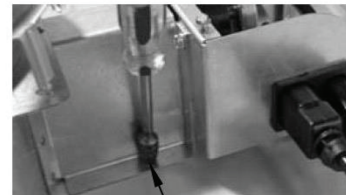

1/4" NUT DRIVER
DAMPER
TOP OF WATER HEATER

- Step 10. Re-install the draft hood from Step 3.
- Step 11. Reconnect the vent system to the draft hood.
- Step 12. Reconnect the cord sets from step 4.
- Step 13. Plug the water heater into the wall outlet.
- Step 14. Position the gas control power switch to the "ON" position.

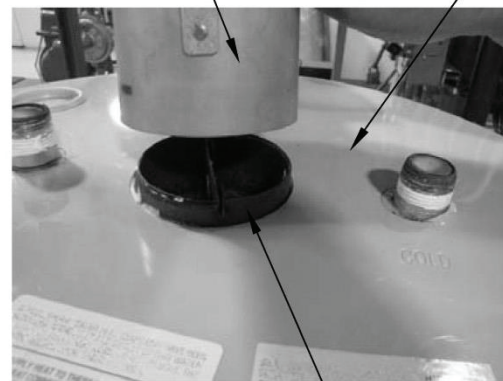

WATER HEATER
TANK FLUE

- Step 15. To resume operation, follow the instructions located on the lighting instruction label or the lighting instructions located in the installation and operation manual.

ULN Res. D Series

SERVICE PROCEDURE D-IV
Gas Control Testing
and Replacement

Line Pressure

The gas control is designed for a maximum line pressure of 14.0" W.C. and a minimum line pressure of 1.0" W.C. over the water heater's rated manifold pressure (check rating plate). Line pressure must be checked with the main burner on and off to assure proper readings.

Manifold Pressure Testing

(this procedure presumes a maximum line pressure of 14.0" W.C.)

- Step 1. Set the Gas Control to the "OFF" position.
- Step 2. Remove pressure tap plug and install 1/8" NPT pipe, coupling & pressure tap.
- Step 3. Connect manometer to pressure tap.
- Step 4. Follow instructions located on the lighting instructions label and proceed to light the main burner and observe manometer reading.
- Step 5. Proper operating range for Natural Gas is 5.0" \pm 0.5" W.C.
- Step 6. If pressure is within the range specified in the previous step, set Gas Control knob to the "OFF" position, remove manometer and pressure tap, and replace pressure tap plug. Check for gas leaks prior to placing water heater back into operation by following the instructions located on the lighting label, or the lighting instructions located in the installation and operation manual.
- Step 7. If gas pressure is outside the specification noted above, refer to page 20 to replace gas control or valve body.

GAS CONTROL
SHOWN IN THE
"OFF" POSITION



3/16"
ALLEN
WRENCH



PRESSURE TAP
SHOWN INSTALLED

ECO (Energy Cut Out)

The ICON System gas control is designed with an ECO device that will reset.

To reset the gas control after a status code (4), turn the gas control knob to the “OFF” position and wait a minimum of (5) minutes before relighting following the instructions located on the lighting instruction label or the lighting instructions located in the installation and operation manual.

Determine Water Temperature Inside Tank

⚠ WARNING

Stored water may be **HOT** WHEN PERFORMING THE FOLLOWING STEPS IN THIS PROCEDURE. Take necessary precaution to prevent personal injury.

- Step 1. Position gas control power switch to “OFF” position.
- Step 2. Draw approximately 4 gallons of water from the drain valve into a container and discard. Draw an additional gallon and immediately measure water temperature using an accurate thermometer (It may be necessary to open a hot water faucet to allow heater to drain).
- Step 3. Compare the measured water temperature with the setting on the gas control. In most instances, they should not differ by more than approx. 10°F.

ULN Res. D Series

SERVICE PROCEDURE D-IV
Gas Control Testing
and Replacement

Gas Control Removal From Water Heater

- Step 1. Position the gas control power switch to the "OFF" position and unplug heater from wall outlet.
- Step 2. Drain the heater to a point below the gas control level.
- Step 3. Turn off the gas supply to the water heater and disconnect gas piping from the gas control.
- Step 4. Disconnect damper and FVIR wire harnesses from the gas control.
- Step 5. Remove outer jacket door.
- Step 6. Disconnect pilot tubing nut (7/16" wrench) and feedline nut (3/4" wrench) from gas control. Swing feedline counter clockwise.
- Step 7. Disconnect igniter/flame sensor wire from gas control.
- Step 8. Remove gas control from water heater by rotating counter clockwise. DO NOT use a wrench on the gas control body, damage to the gas control may occur. If necessary, use a length of 1/2" NPT pipe threaded into the gas inlet of gas control.

GAS CONTROL
SHOWN IN THE
"OFF" POSITION

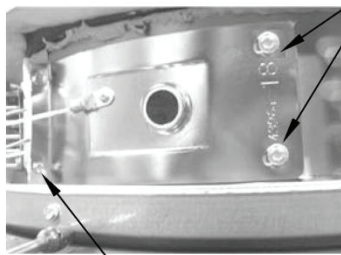

1/4" HEX DRIVE SCREWS
RIGHT AND LEFT SIDE
INNER DOOR.

1/4" HEX DRIVE SCREWS
AT FLANGE AREA OF
INNER DOOR

- Step 9. Install a new gas control into the water heater by rotating clockwise. DO NOT use a wrench on the gas control body. Damage to the gas control may occur. If necessary, use a length of 1/2" NPT pipe threaded into the gas inlet of the gas control.
- Step 10. Reattach main burner feedline and pilot tube.
- Step 11. Reattach igniter/flame sensor wire.
- Step 12. Connect damper and FVIR wire harnesses to the gas control.
- Step 13. Reinstall outer door.
- Step 14. To resume operation, follow the instructions located on the lighting instruction label or the lighting instructions located in the installation and operation manual.

ULN Res. D Series

SERVICE PROCEDURE D-V
Flammable Vapor Device
Testing and Replacement

Flammable Vapor Testing

Step 1. Position power switch on gas control to the "OFF" position.

Step 2. Remove the outer door.

Step 3. Disconnect the black wire leads from the FVIR sensor.

Step 4. Using a multi-meter set to the ohms setting, check resistance of flammable vapor sensor. Resistance must be between 3,000 ohms and 48,000 ohms. If outside of this range replace Flammable Vapor Sensor.

Step 5. Plug the black wire leads into either post, they are interchangeable.

Step 6. Plug the water heater back in and position the switch on the gas control to the "ON" position.

Step 7. To resume operation, follow the instructions located on the lighting instruction label or the lighting instructions located in the installation and operation manual.

GAS CONTROL
SHOWN IN THE
"OFF" POSITION



FLAMMABLE VAPOR
SENSOR HARNESS

FVIR SENSOR
IN MOUNTING
CLIP

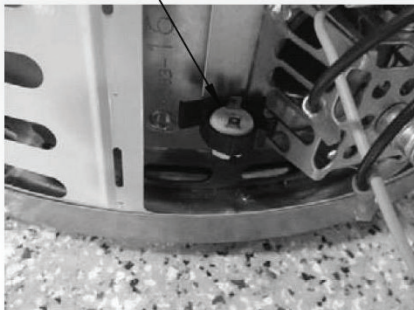

Diptube Inspection & Replacement

⚠ WARNING

Water Heater components and stored water may be **HOT** when performing the following steps in this procedure. Take necessary precaution to prevent personal injury.

- Step 1. Position the on/off switch of the gas control valve to the “OFF” position and unplug the water heater from the wall outlet.
- Step 2. Turn off the cold water supply to the water heater. Connect a hose to the drain valve of the water heater and route to an open drain. Open a nearby hot water faucet to vent the water heater for draining. Open the drain valve of the water heater and allow the water heater to drain to a point below the inlet connection nipple.
- Step 3. Disconnect the inlet nipple from the plumbing system.
- Step 4. With an appropriate tool such as a pipe wrench, remove the inlet nipple/diptube from the water heater. Use caution not to damage the pipe threads.
- Step 5. Visually inspect the inlet nipple/diptube. The inlet nipple/diptube should be free of cracks and any blockage. The Hydrojet slots should be open and free of any blockage. Any damage such as cracks, restriction due to deformation or unintentional holes are not field repairable and the inlet nipple/diptube must be replaced.
- Step 6. Upon completion of inspection or subsequent replacement, reinstall the inlet nipple/diptube into the water heater. Ensure pipe dope is used on the nipple’s threads. Connect the nipple to the plumbing system, resume water supply and refill with water.
- Step 7. To resume operation follow the instructions located on the lighting instruction label or the lighting instructions located in the installation and operation manual.

Anode Inspection & Replacement

⚠ WARNING

Water Heater components and stored water may be **HOT** when performing the following steps in this procedure. Take necessary precaution to prevent personal injury.

- Step 1. Position the on/off switch of the gas control valve to the “OFF” position and unplug the water heater from the wall outlet.
- Step 2. Turn off the cold water supply to the water heater. Connect a hose to the drain valve of the water heater and route to an open drain. Open a nearby hot water faucet to vent the water heater for draining. Open the drain valve of the water heater and allow the water heater to drain to a point below the outlet connection nipple.
- Step 3. Disconnect the outlet nipple from the plumbing system.
- Step 4. With an appropriate tool such as a pipe wrench, remove the outlet nipple/anode from the water heater. Use caution not to damage the pipe threads.
- Step 5. Visually inspect the outlet nipple/anode. The outlet nipple/anode should show signs of depletion, this is normal. If depletion is $\frac{1}{2}$ of the original anode diameter (approximately $\frac{3}{4}$ ” diameter), replacement is recommended. If any of the steel core of the anode is exposed, replacement is recommended.
- Step 6. Upon completion of inspection or subsequent replacement, reinstall the outlet nipple/anode into the water heater. Ensure pipe dope is used on the nipple’s threads. Connect the nipple to the plumbing system, resume water supply and refill with water.
- Step 7. To resume operation, follow the instructions located on the lighting instruction label or the lighting instructions located in the installation and operation manual.

ULN Res. D Series

SERVICE PROCEDURE D-VIII
Flue Baffle Inspection and
Replacement

Flue Baffle Inspection and Replacement

- Step 1. Position the on/off switch of the gas control valve to the "OFF" position and unplug the water heater from the wall outlet.
- Step 2. Disconnect the vent system from the draft hood that is mounted on top of the damper.
- Step 3. Remove the draft hood from the damper and retain it for later use.

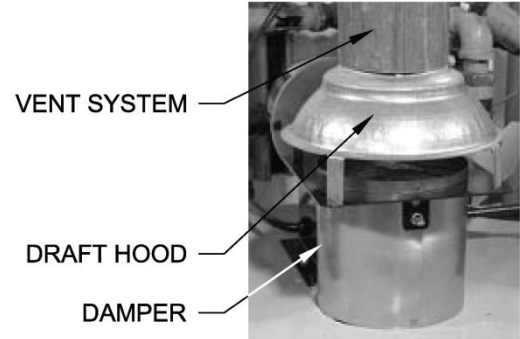

- Step 4. Disconnect the cord sets from the damper.

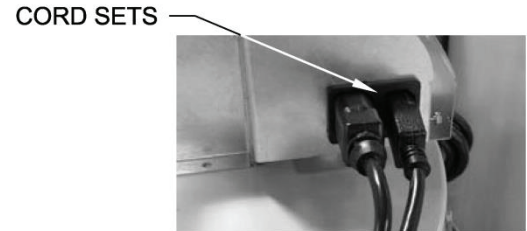

- Step 5. Remove the 2 screws from the damper mounting screws using a 1/4" nut driver and retain for later.

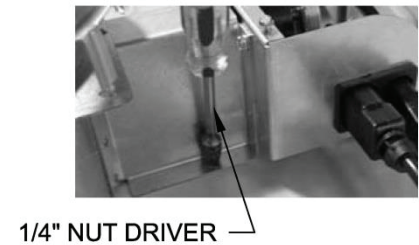

Flue Baffle Inspection and Replacement (cont.)

- Step 6. Carefully remove the damper from the top of the water heater.
- Step 7. Remove the flue baffle from the water heater.
- Step 8. Inspect the baffle for deterioration and missing restrictors. Clean any scale or debris build-up. Replace with a new baffle, as necessary.

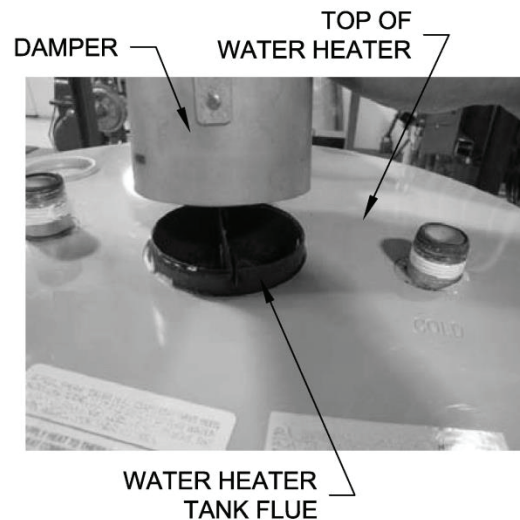

- Step 9. Reinstall the baffle into the flue. Be sure the baffle hanger tab is inserted into the notch locations at the top of the flue.
- Step 10. Check the burner to ensure no scale has accumulated during operation. See the "Burner Cleaning Procedure" on page 14, if accumulation has occurred.
- Step 11. Clean any debris from the jacket head of the water heater.
- Step 12. Set the new damper in place using the water heater tank flue and the screw holes in the jacket head.
- Step 13. Secure the damper in place using the screws from step 5.
- Step 14. Re-install the draft hood from Step 3.
- Step 15. Reconnect the vent system to the draft hood.
- Step 16. Reconnect the cord sets from step 4.
- Step 17. Plug the water heater into the wall outlet.
- Step 18. Position the gas control power switch in to the "ON" position.
- Step 19. To resume operation, follow the instructions located on the lighting instruction label or the lighting instructions located in the installation and operation manual.

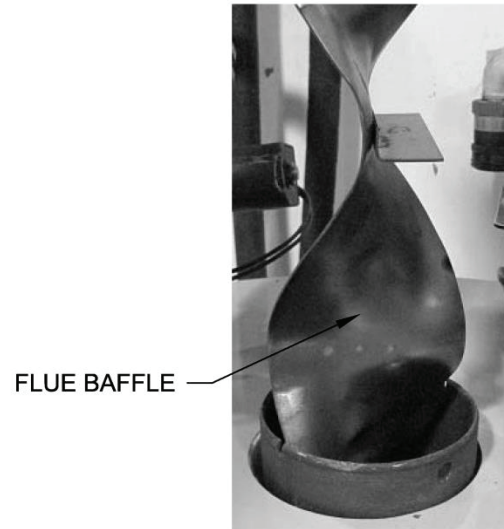

Inner Door Removal Procedure

- Step 1. Position gas control power switch to the "OFF" position.
- Step 2. Remove outer jacket burner access door.
- Step 3. Remove (2) 1/4" hex drive screws from right side inner door.
- Step 4. Remove (2) 1/4" drive screws from flange section of inner door.
- Step 5. Remove (3) 1/4" drive screws from left side inner door.
- Step 6. Remove inner door and inspect per step 7.

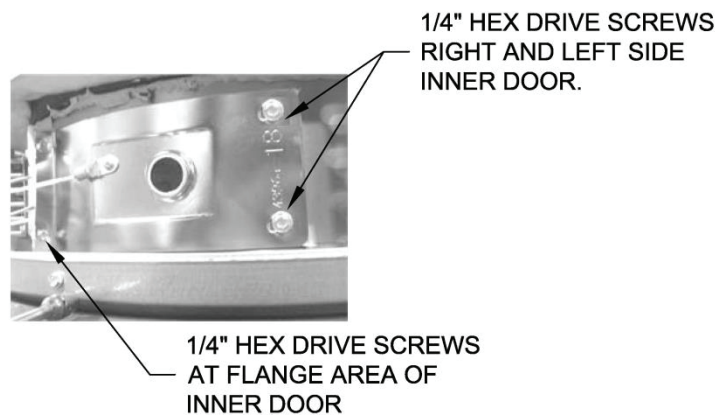

- Step 7. Fully inspect inner door gaskets for the following:
- Tears
 - Missing Material
 - Cracks
 - Dirt or debris
 - Other imperfections that will inhibit proper seal
 - Gasket adhesion to inner door
 - Material left on combustion chamber (around opening)

If the gasket is not affected by any of the above, gasket replacement is not required. If replacement is required, proceed to **Inner Door Gasket Replacement Procedure**.

Inner Door Gasket Replacement Procedure

⚠ WARNING

If the information in these instructions is not followed exactly, a fire or explosion may result causing property damage, personal injury or death.

- Step 8. After inspection of inner door as noted in step 7, completely remove gasket and adhesive residue from right and left side inner doors as needed.

ULN Res. D Series

SERVICE PROCEDURE D-IX
Inner Door Removal,
Inspection and Replacement

- Step 9. Use RTV sealant (recommended bead size 1/8") to secure the inner door gasket to the inner door sections (right & left). Refer to illustration below for proper application. Note the overlap configuration in the flange area of the inner door. Set the flange section first, this will help to achieve the proper overlap position.

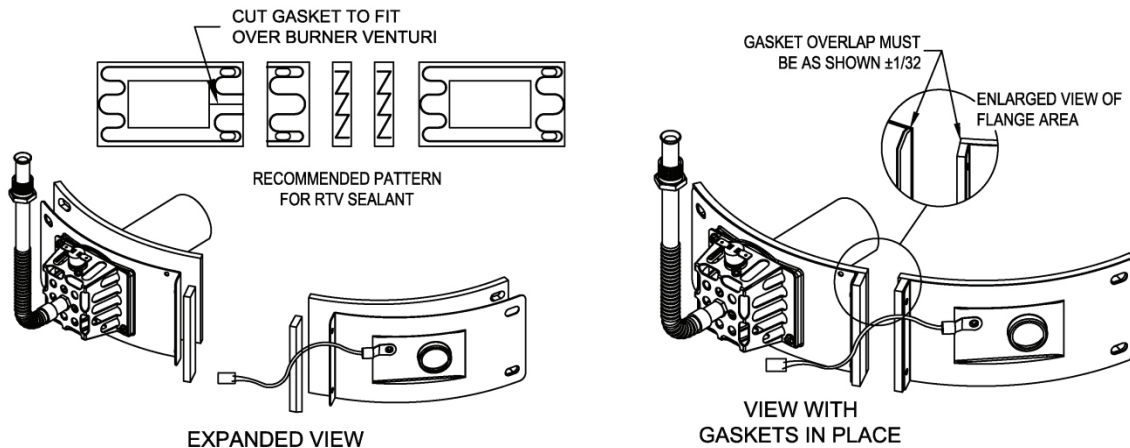

Installation of Inner Door With Gasket

- Step 10. Clean any residual gasket residue or other debris from combustion chamber surface before installing the inner door/gasket assembly.
- Step 11. Place the left side inner door with burner assembly into position first. Using the 1/4" hex drive screws from step 5, secure left side inner door in place.
DO NOT OVER TIGHTEN SCREWS
- Step 12. Position pilot tube and igniter/sensor wire against left side inner door flange gasket.

⚠ WARNING

Stripped fastener connections may allow for seal breach of inner door. A seal breach may result in a fire or explosion causing property damage, personal injury or death. Do not over tighten screws in steps 8, 10 and 11.

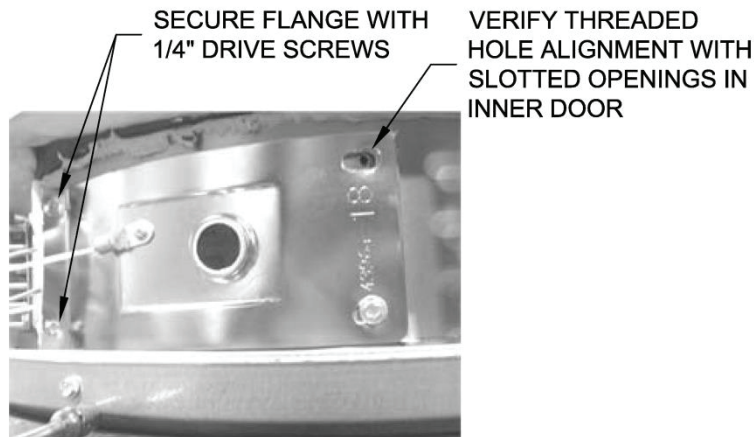

Installation of Inner Door With Gasket (cont.)

- Step 13. Firmly place right side inner door flange against the left side inner door flange and secure with (2) 1/4" hex drive screws from step 4. **DO NOT OVER TIGHTEN SCREWS.**
- Step 14. Align right side inner door to combustion chamber and verify the fastener holes of the combustion chamber are aligned with right side inner door slotted opening. Verify seal integrity around combustion opening. Secure right side inner door using 1/4" hex drive screws from step 3. **DO NOT OVER TIGHTEN SCREWS.** Verify both left and right sides of inner door are properly positioned and sealed against the combustion chamber.

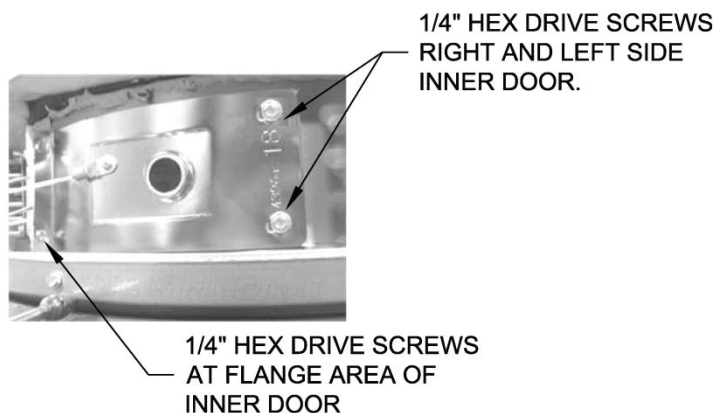

- Step 15. Replace outer jacket burner access door.
To resume operation follow the instructions located on the lighting instruction label or the lighting instructions located in the installation and operation manual.

ULN Res. D Series

SERVICE PROCEDURE D-X
115 VAC Circuit Trace

115 VAC Circuit Trace

- Step 1. Verify 115 VAC and proper polarity at wall outlet.
- Step 2. With unit plugged in and control power switch in the "ON" position verify LED status.

⚠ WARNING
115 volt potential exposure. Use caution to avoid personal injury.

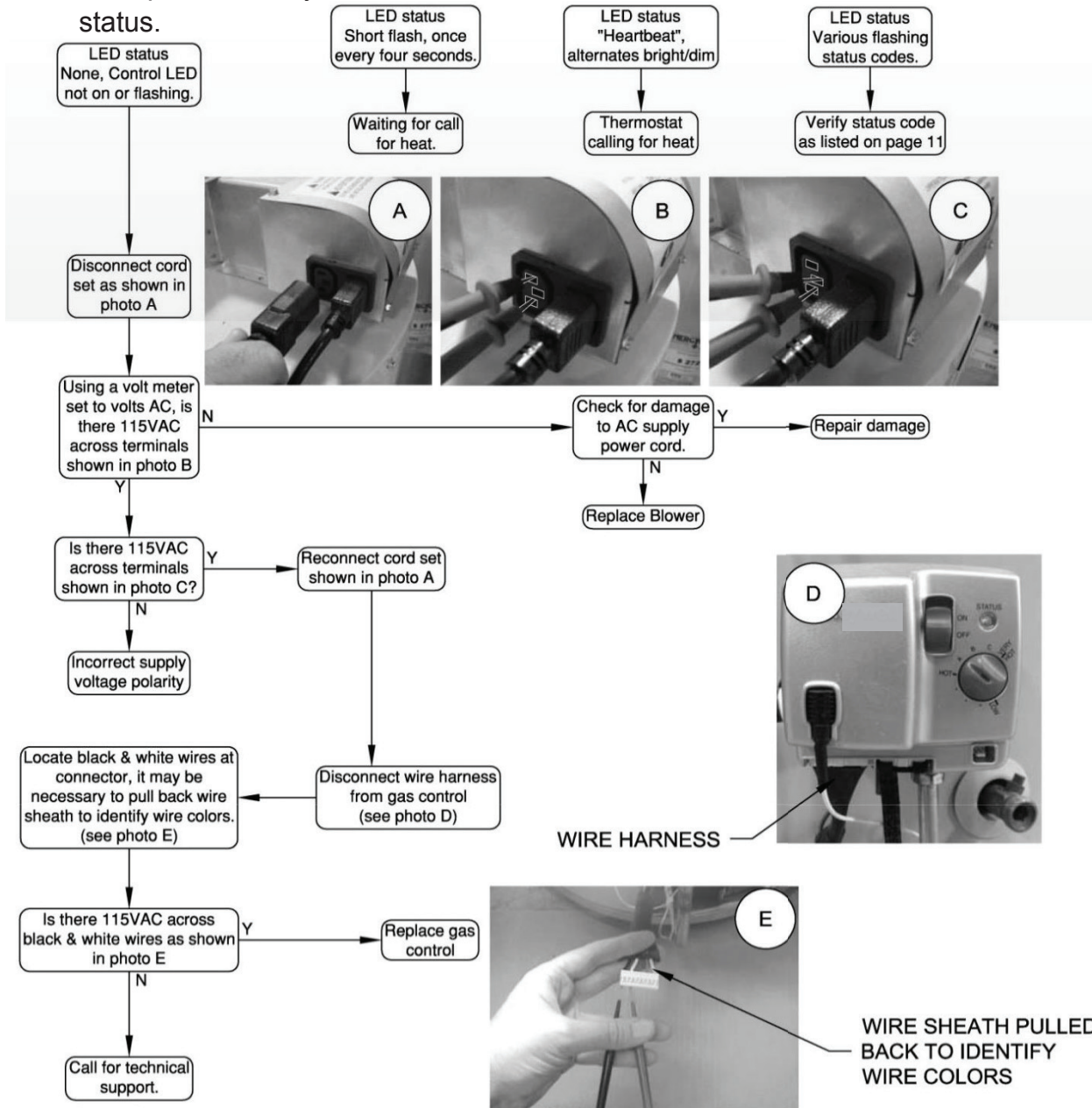

Check for 115VAC between black & white wires.

-NOTE-

Electronic meter probes required. Use care not to damage connector during this check.

Damper Relay Installation

If the damper fails and the water heater operation is necessary temporarily, a relay, p/n 233-47642-00, and harness, p/n 239-51714-00, can be ordered from the Bradford White Service Parts Department.

- Step 1. Position the gas control power switch to the "OFF" position and unplug the water heater from the wall outlet.
- Step 2. Disconnect the vent system from the draft hood that is mounted on top of the damper.
- Step 3. Remove the draft hood from the damper and retain it for use later.
- Step 4. Unplug the cord sets from the damper.
- Step 5. Remove the two damper housing screws using a 1/4" nut driver or wrench and retain for later use.

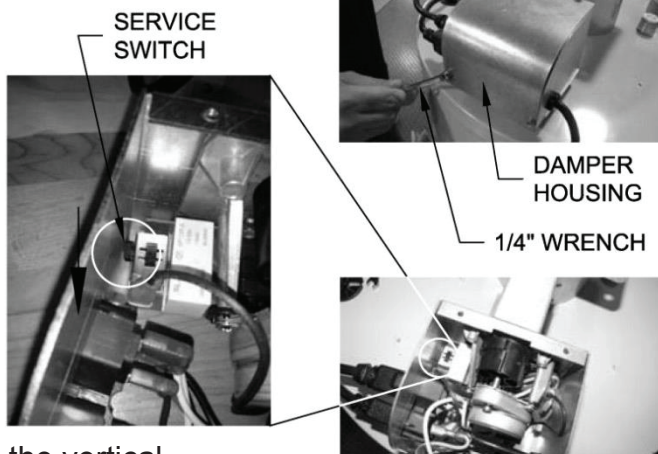
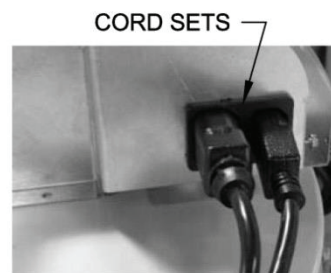
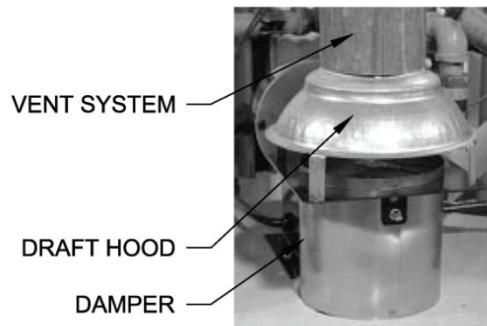

- Step 6. Move the damper blade into the vertical position.

DAMPER BLADE

- Step 7. Move the switch inside the back of the damper to the "Service" position (towards the back of the water heater, as shown in the illustration above).



Damper Relay Installation (cont.)

Step 8. Remove the Red wire in the damper housing from its location. Connect the ¼" Red female connector on the relay harness in its place

Step 9. Remove the Yellow wire in the damper housing from its location. Connect the ¼" Yellow female connector on the relay harness in its place.

Step 10. Remove the Blue wire in the damper housing from its location. Connect the ¼" Blue female connector on the relay harness in its place.

Step 11. Remove the White wire in the damper housing from its location. Connect the ¼" White female connector with the piggy back connector on the relay harness in its place.

Step 12. Using the White wire that was removed in Step 11, connect it to the piggyback spade connector that was installed in Step 11.

Step 13. Connect the other ends of the relay harness to the relay, as shown.

Step 14. Place the relay and its harness fully inside the damper housing.

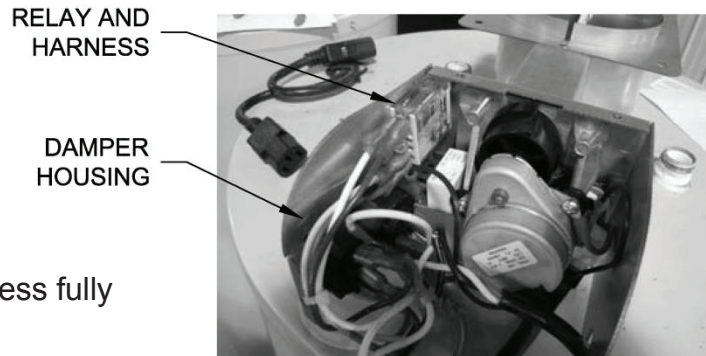
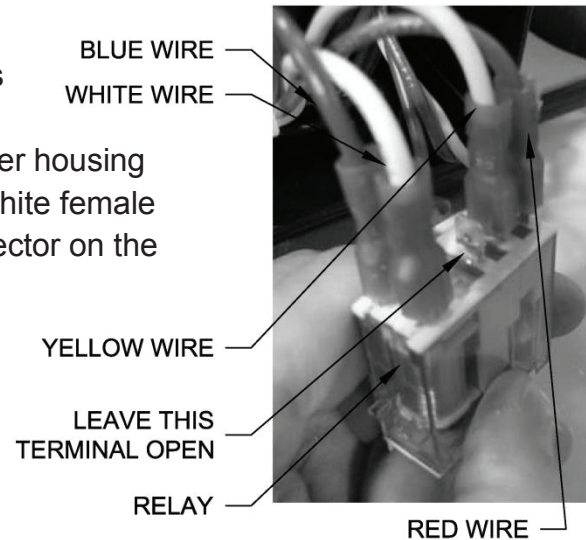
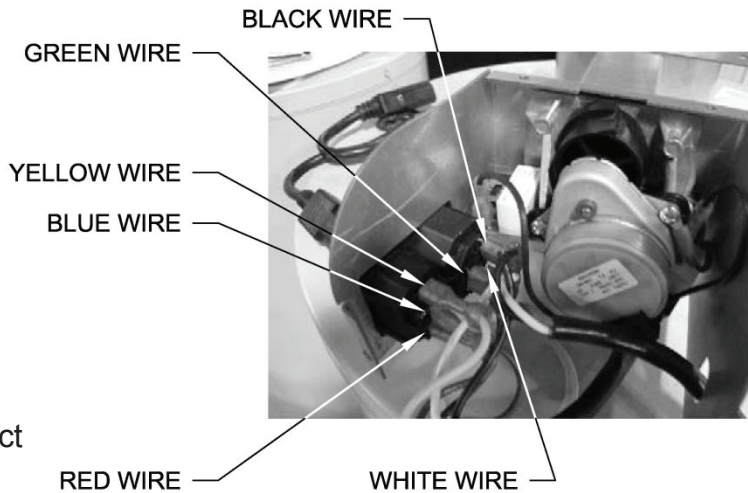

Damper Relay Installation (cont.)

- Step 15. Secure the damper housing cover in place using the screws from step 5.
- Step 16. Re-install the draft hood from Step 3.
- Step 17. Reconnect the vent system to the draft hood.
- Step 18. Reconnect the cord sets from step 4.
- Step 19. Plug the water heater into the wall outlet.
- Step 20. Move the gas control power switch in to the "ON" position.

To resume operation, follow the instructions located on the lighting instruction label or the lighting instructions located in the Installation and Operation manual.

ULN Res. D Series

SERVICE PROCEDURE D-XII
Chamber Sensor,
Testing and Replacement

Chamber Sensor Testing

- Step 1. Position the gas control power switch to the "OFF" position and unplug the water heater from the wall outlet.
- Step 2. Disconnect flammable vapor sensor harness from the gas control.
- Step 3. Remove the outer door.
- Step 4. Remove the chamber door temperature sensor from the right side inner door (Phillips screw driver).

GAS CONTROL
SHOWN IN THE
"OFF" POSITION



FLAMMABLE VAPOR
SENSOR HARNESS

- Step 5. Make sure that the ring terminal of the chamber door temperature sensor is not touching any surface. Using a multi-meter, set to the ohms setting, insert one meter probe (see Caution) into each of the yellow wire positions (see photo below).
- Step 6. Check the temperature of the ring terminal.
- Step 7. Confirm the resistance reading measured is within the corresponding temperature range that the ring terminal is at.
- Step 8. If the resistance reading measured does not fall within the resistance range for the ring terminal's temperature, replace the flammable vapor/chamber sensor harness.



CHAMBER DOOR
TEMPERATURE
SENSOR

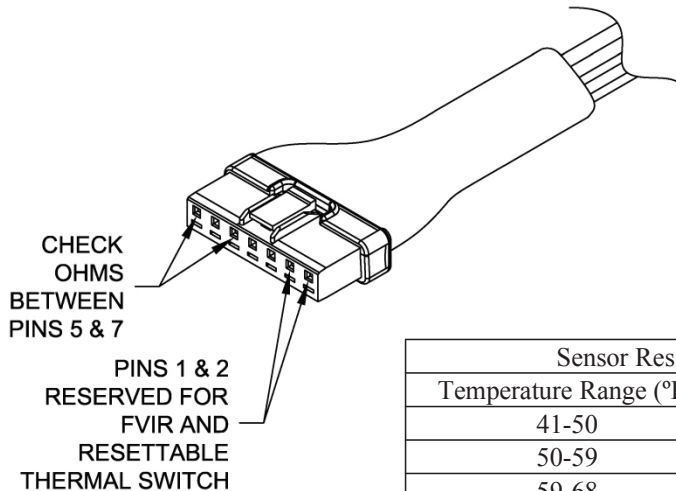

CAUTION

DO NOT use a standard multi-meter probe for this test. Doing so will damage connector. Use special pin type electronic probes or small diameter wire pins inserted into connector.

Sensor Resistance at Various Temperatures	
Temperature Range (°F)	Resistance Range (kOhms)
41-50	279-175
50-59	219-139
59-68	173-112
68-77	137-90
77-86	110-72
86-104	89-59
104-113	73-48
113-122	60-39
122-131	49-32

ULN Res. D Series

Resettable Thermal Switch Continuity Testing

- Step 1. Remove outer jacket door.
- Step 2. Disconnect black wire leads from the resettable thermal switch.
- Step 3. Using a multimeter capable of measuring continuity (Ohms), place one probe of the meter on one of the brass connection tabs of the resettable thermal switch, and the remaining probe on the other connection tab.
- Step 4. If continuity is indicated, the switch is closed, allowing millivolt current to pass.
- Step 5. If continuity is not indicated, the switch is open, possibly due to an overheating condition. The switch is designed to open at predetermined temperatures. An open switch can be reset by depressing the red colored button located at the center of the switch. The overheating condition must be determined prior to putting the water heater back into service.

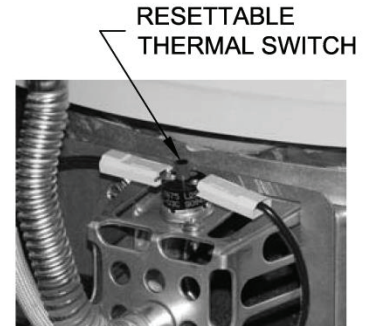

Resettable Thermal Switch Color Code Reference		<u>Probable Cause for Resettable Thermal Switch Activation</u>	
Color code	Approximate switch activation temperature (open)	<u>Probable Cause</u>	<u>Corrective Action</u>
Blue	240°	Insufficient combustion air	1. Verify adequate combustion air supply is available. 2. Clear jacket slot openings of any dirt, dust, restrictions or other obstructions. 3. Inspect flame arrestor plate and clean with a stiff brush, compressed air and/or vacuum to remove scale deposits and debris.
Yellow	270°		
Red	290°	1. Weak switch or switch is out of calibration. 2. Incorrect switch.	1. Replace resettable thermal switch. 2. Verify switch color code and approximate temperature.
		Flammable vapor incident	Replace water heater

Resettable Thermal Switch Replacement

- Step 1. Rotate gas control knob to the "OFF" position.
- Step 2. Remove outer jacket door.
- Step 3. Disconnect the black wire leads from resettable thermal switch.
- Step 4. Remove (2) 1/4" hex drive screws from the manifold mount.
- Step 5. Remove resettable thermal switch from manifold mount (Phillips screw driver).
- Step 6. Place new resettable thermal switch in place. Be sure contact surface of resettable thermal switch and manifold mount are free of any debris. Secure resettable thermal switch into place using screws from step 6.
DO NOT OVER TIGHTEN SCREWS.
- Step 7. Reconnect the black wire leads from gas valve and thermopile to resettable thermal switch.

Note: Wire terminations are interchangeable with either resettable thermal switch connection.

- Step 8. Replace outer jacket door.

To resume operation follow the instructions located on the lighting instruction label or the lighting instruction located in the installation and operation manual.

GAS CONTROL
SHOWN IN THE
"OFF" POSITION



MANIFOLD
MOUNT

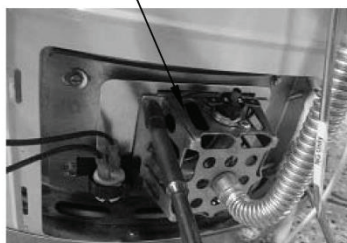

ScreenLok® Flame Arrestor Cleaning

- Step 1. Position Gas Control power switch to the “OFF” position.
- Step 2. Remove outer door.
- Step 3. Remove outer jacket door and inner door per service procedure IX on page 26.
- Step 4. Disconnect main burner feedline (3/4” wrench), pilot tube (7/16” wrench) and igniter/flame sensor wire from gas control and remove burner assembly from combustion chamber.
- Step 5. Clean ScreenLok® Flame Arrestor using a stiff brush, compressed air and/or shop vacuum to remove any scale or other debris accumulation. Then, using a soft brush, clear jacket openings from any dirt, dust, restrictions or other obstructions.
- Step 6. Remove any debris from the burner assembly per procedure D-I on page 14 and reinstall burner assembly into combustion chamber.
- Step 7. Reconnect the feedline, pilot tube and igniter/flame sensor wire to the gas control
- Step 8. Reinstall the outer jacket door and the inner doors per service procedure D-IX on page 26.

To resume operation follow the instructions located on the lighting instruction label or the lighting instructions located in the Installation and Operation manual.

Glossary of Terms

BTU	British Thermal Units
GPM	Gallons per Minute
Hz	Hertz
kWh	Kilowatt hour Light
LED	Emitting Diode National
NPT	Pipe Thread Ohm
Ohms	s of resistance Pounds
psi	per Square Inch
RPM	Revolutions per minute
ECO	Energy Cut Out
VAC	Volts Alternating Current
" w.c.	Inches of Water Column
°C	Degrees Centigrade
°F	Degrees Fahrenheit

ULN Res. D Series

Parts List

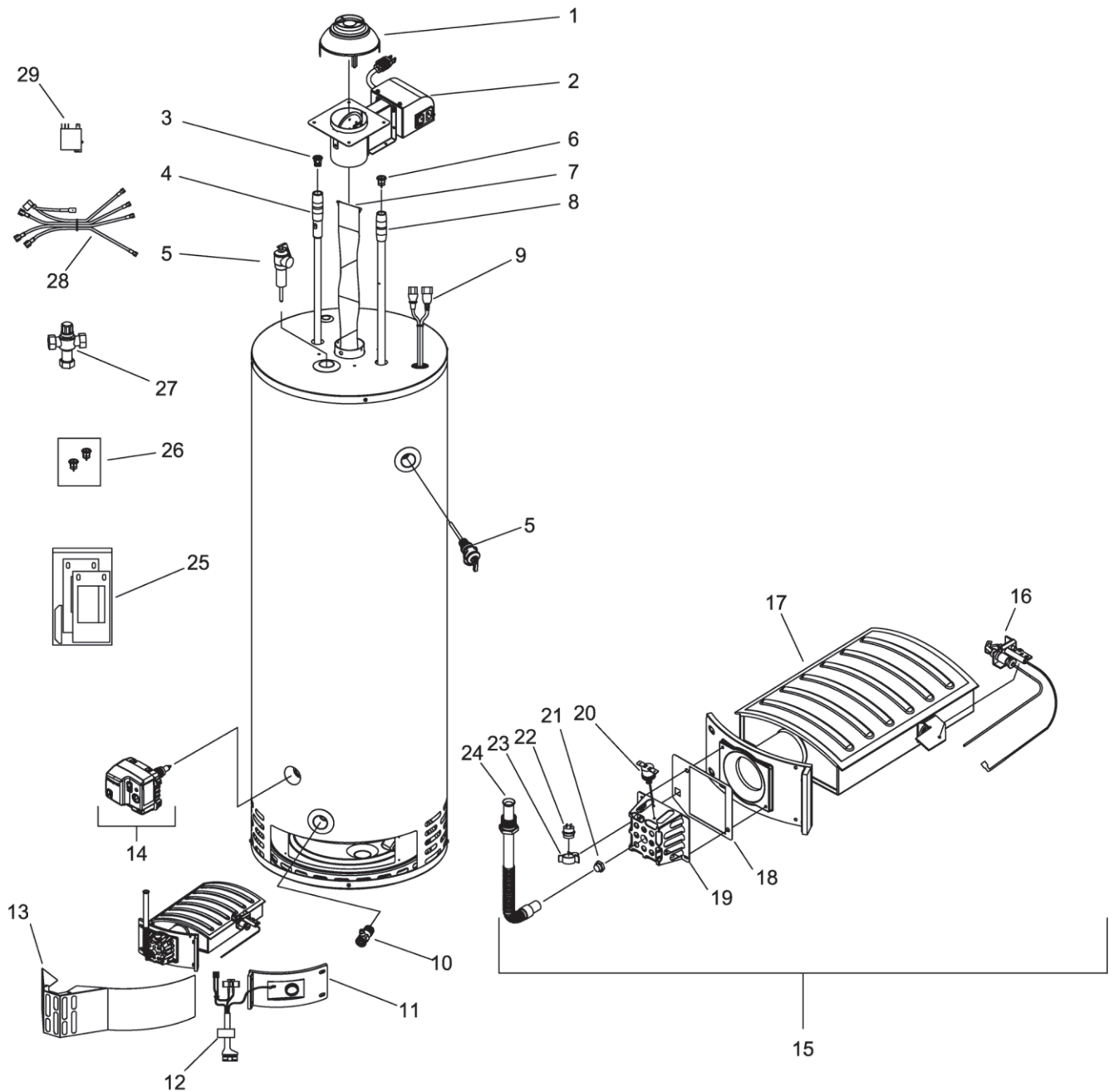

- | | | | |
|------------------------------------|-------------------------------------|-------------------------------------|---------------------------|
| 1. Draft Diverter | 9. Draft Diverter | 17. Draft Diverter | 25. Inner door gasket kit |
| 2. Damper | 10. Damper | 18. Damper | 26. Heat trap kit |
| 3. Heat Trap Outlet | 11. Heat Trap Outlet | 19. Heat Trap Outlet | 27. ASSE mixing device |
| 4. Hot Water Outlet Anode | 12. Hot Water Outlet Anode | 20. Hot Water Outlet Anode | 28. Damper svc harness |
| 5. Temp. and Pressure relief valve | 13. Temp. and Pressure relief valve | 21. Temp. and Pressure relief valve | 29. Damper svc relay |
| 6. Heat Trap Inlet | 14. Heat Trap Inlet | 22. Heat Trap Inlet | |
| 7. Flue Baffle | 15. Flue Baffle | 23. Flue Baffle | |
| 8. Inlet Diptube | 16. Inlet Diptube | 24. Feedline | |



United States

Sales 800-523-2931

Technical Support 800-334-3393

Email techserv@bradfordwhite.com

Warranty 800-531-2111

Email warranty@bradfordwhite.com

Service Parts 800-538-2020

Email parts@bradfordwhite.com

Canada

Sales & Technical Support 866-690-0961 905-203-0600

Fax 905-636-0666

Warranty bwccwarranty@bradfordwhite.com

Technical Support bwccotech@bradfordwhite.com

Service Parts orders@bradfordwhitecanada.com

Orders ca.orders@bradfordwhite.com

For U.S. and Canada field service,
contact your professional installer or
local Bradford White sales representative.

International

General Contact international@bradfordwhite.com