



Flammable Vapor Ignition Resistant Water Heaters

Ultra Low NOx Direct Vent Water Heaters



SERVICE MANUAL

Troubleshooting Guide
and Instructions for Service

(To be performed ONLY by
qualified service providers)



**Models Covered
by This Manual:**

URG2DV40S*N
URG2DV50S*N
URG2DV50H*N
ULG2DV50H50*N
(* Denotes Warranty Years)



As required by the state of California Proposition 65.

UDV Series

Ultra Low NO_x Direct Vent Water Heaters

Table of Contents

	<u>Page</u>	<u>UDV SVC Procedure</u>
Introduction	4	---
How to Use This Manual	4	---
Tools Required for Service	5	---
Troubleshooting	6	---
Burner Inspection, Cleaning & Replacement	9	I
Pilot Testing, Cleaning & Replacement	11	II
Gas Control Testing & Replacement	13	III
Thermopile Testing	16	IV
Igniter, Electrode Testing and Replacement	17	V
Inner Door Removal and Replacement	18	VI
Diptube Inspection & Replacement	21	VII
Anode Inspection & Replacement	22	VIII
Glossary of Terms	23	---
Parts List	24	---

UDV Series

WARNING: If the information in these instructions is not followed exactly, a fire or explosion may result causing property damage, personal injury, or death.

FOR YOUR SAFETY

Do not store or use gasoline or other flammable, combustible, or corrosive vapors and liquids in the vicinity of this or any other appliance.

WHAT TO DO IF YOU SMELL GAS!

- Do not try to light any appliance.
- Do not touch any electrical switch; do not use any phone in your building.
- Immediately call your gas supplier from a neighbor's phone. Follow the gas supplier's instructions.
- If you cannot reach your gas supplier, call the fire department.

Installation and service must be performed by a qualified installer, service agency or the gas supplier.

▲ DANGER

Do not store or use gasoline or other flammable, combustible, or corrosive vapors and liquids in the vicinity of this or any other appliance.

IMPORTANT

Before proceeding, please inspect the water heater and its components for possible damage. **DO NOT** install any water heater with damaged components. If damage is evident then please contact the supplier where the water heater was purchased or the manufacturer listed on the rating plate for replacement parts.

▲ WARNING

Water heaters are heat producing appliances. To avoid damage or injury, do not store materials against the water heater or vent-air intake system. Use proper care to avoid unnecessary contact (especially by children) with the water heater and vent-air intake components. **UNDER NO CIRCUMSTANCES MUST FLAMMABLE MATERIALS, SUCH AS GASOLINE OR PAINT THINNER BE USED OR STORED IN THE VICINITY OF THIS WATER HEATER, VENT-AIR INTAKE SYSTEM OR IN ANY LOCATION FROM WHICH FUMES COULD REACH THE WATER HEATER OR VENT-AIR INTAKE SYSTEM**

▲ CAUTION

If sweat fittings are to be used **DO NOT** apply heat to the nipples on top of the water heater. Sweat the tubing to the adapter before fitting the adapter to the water connections. It is imperative that heat is not applied to the nipples containing a plastic liner.

▲ WARNING

Hydrogen gas can be produced in an operating water heater that has not had water drawn from the tank for a long period of time (generally two weeks or more). Hydrogen gas is extremely flammable. To prevent the possibility of injury under these conditions, we recommend the hot water faucet to be open for several minutes at the kitchen sink before you use any electrical appliance which is connected to the hot water system. If hydrogen is present, there will be an unusual sound such as air escaping through the pipes as hot water begins to flow. Do not smoke or have open flame near the faucet at the time it is open.

▲ WARNING

DO NOT ATTEMPT TO LIGHT ANY GAS APPLIANCE IF YOU ARE NOT CERTAIN OF THE FOLLOWING:

- Liquefied petroleum gases/propane gas and natural gas have an odorant added by the gas supplier that aids in the detection of the gas.
- Most people recognize this odor as a "sulfur" or "rotten egg" smell.
- Other conditions, such as "odorant fade" can cause the odorant to diminish in intensity, or "fade", and not be as readily detectable.
- If you have a diminished sense of smell, or are in any way unsure of the presence of gas, immediately contact your gas supplier from a neighbor's telephone.

Gas detectors are available. Contact your gas supplier, or plumbing professional, for more information.

▲ WARNING

FAILURE TO INSTALL AND MAINTAIN A NEW, LISTED 3/4" X 3/4" TEMPERATURE AND PRESSURE RELIEF VALVE WILL RELEASE THE MANUFACTURER FROM ANY CLAIM THAT MIGHT RESULT FROM EXCESSIVE TEMPERATURE AND PRESSURES.

UDV Series

Introduction

The new Bradford White UDV water heaters are designed to provide reliable performance with enhanced standard features. Design features include reliable standing pilot ignition system, enhanced diagnostics, simplified servicing, certified FVIR technology, and Ultra Low NO_x emissions.

The UDV water heaters use a combustion system where combustion air is drawn from the outside of the building. The gas control maintains water temperature and maintains gas flow. If a situation outside of the normal operating parameters exists, the gas control diagnostic LED will flash a code to identify an operational issue.

This service manual is designed to facilitate problem diagnosis and enhance service efficiency.

Please read the service manual completely before attempting service on this new series of direct vent water heaters.

How the Safety System Works

During normal operation, most air for combustion is drawn into the water heater through the openings in the jacket door. This air travels into the burner venturi, mixing the gas jet. This air is then mixed with gas inside the burner and drawn into the burner screen and is efficiently combusted producing Ultra Low NO_x emissions. Additional air is drawn through the openings in the jacket. This air travels down and around the combustion chamber and enters through holes in the bottom of the corrosion resistant combustion chamber. The air then travels up through the oriented flame arrestor plate louvers, where the velocity of the air is increased and its direction altered. The air then mixes in a normal manner with the combustion products from the burner.

In the case where trace amounts of flammable vapors are present in the air flowing into the combustion chamber and burner venturi, the vapors are harmlessly ignited by the burner pilot flame. If flammable vapors are in sufficient quantity to prevent normal combustion, the burner and pilot flames are designed to shut down.

Should the flammable vapors continue to the burner, the flame arrestor plate and burner screen prevent the flames from traveling backwards and igniting vapors outside of the combustion chamber. This causes the thermopile to overheat and shuts down the main pilot and burner. The thermopile powers the intelligent diagnostic control which is capable of recognizing restricted airflow conditions caused by severe lint, dust and oil accumulation on the burner screen and arrestor plate. The intelligent diagnostic control will deactivate the burner and pilot in the unlikely event of restricted airflow.

UDV Series

How to use this Manual

It is intended for this manual to be used by qualified service personnel for the primary purpose of troubleshooting and repair of the Bradford White UDV Series water heaters.

The Honeywell WV8840 Gas Control will display status codes in the event of abnormal operation. Status codes are listed in the troubleshooting chart beginning on page 6 of this service manual. The troubleshooting chart on page 6 will also indicate the probable cause for the status code and direct the service professional to a service procedure to properly diagnose the abnormal operation.

In some difficult to diagnose conditions, it may be necessary to isolate the heater from the vent system to determine the problem.

Contact the Bradford White technical support group immediately if diagnosis cannot be made using the methods described in this service manual.

Tools Required for Service

Manometer:	A liquid "U" tube type or a digital (magnahelic) type can be used. This device is used to measure gas and/or air pressure and vacuum.
Multi-Meter:	A digital type is strongly recommended. This device is used to measure electrical values. The meter you select must have the capability to measure volts AC, volts DC, Amps, micro-amps and ohms.
Electronic Probes:	In some cases, standard multi-meter probes will damage or simply not be effective to obtain certain voltage and ohm readings. It will be necessary to have special electronic "pin" type multi-meter probes. These probes are available at most electronic wholesale outlets.
Thermometer:	Used to measure water temperature. An accurate thermometer is recommended.
Water Pressure Gage:	Used to measure water supply pressure. Also used to determine tank pressure by adapting to the drain valve of the heater.
Various Hand Tools:	Pipe wrench, channel locks, open end wrenches (3/8", 7/16", 1/2"), 12" crescent wrench, allen wrench set, screw drivers (common & Phillip's), 1/4" nut driver, pliers (common & needle nose), socket set, side cutters, wire cutters, wire strippers, wire crimpers, torpedo level, small shop vacuum, step ladder, flashlight and 5-gallon pail.

DV Series

Troubleshooting V1

Observe green LED indicator on electronic gas control. Status flash codes are displayed with a three second pause before repeating. Check and repair the system as noted in the troubleshooting table below.



LED Status	Control Status	Probable Cause	Service Procedure
None (LED not on or flashing)	Pilot assembly is not lit	Gas control is not powered. Light Pilot.	If the pilot will not stay lit replace pilot assembly. If problem persists, replace gas control.
One flash and three second pause	<ol style="list-style-type: none"> If setpoint knob is in "PILOT" position, then pilot flame is detected. Turn setpoint knob to desired setting. If the setpoint knob is already at the desired setting, the water heater is satisfied. 	<ol style="list-style-type: none"> Gas control is powered and waiting for setpoint knob to be turned to a water temperature setting. Water heater is satisfied and operating normally. 	Normal operation.
Short flash once per second	Gas control is calling for heat (no fault).	Tank temperature below setpoint of thermostat.	Normal operation.
LED on continuously (solid)	Setpoint knob has been recently turned to the "OFF" position. Wait until LED goes out before attempting to relight.	Setpoint knob was turned to "OFF" position.	LED will go out and the control will function normally the pilot is lit.
Two flashes and three second pause	Weak pilot signal detected. System will reset when pilot flame is sufficient.	<ol style="list-style-type: none"> Thermopile failure. Unstable pilot. Pilot tube block or restricted. 	<ol style="list-style-type: none"> See service procedure IV. See service procedure II. See service procedure II.
Three flashes and three second pause	Insufficient water heating. System will reset.	<ol style="list-style-type: none"> Thermal sensor out of calibration. Faulty gas control. 	Replace gas control.

UDV Series

Troubleshooting V1

Observe green LED indicator on electronic gas control. Status flash codes are displayed with a three second pause before repeating. Check and repair the system as noted in the troubleshooting table below.



LED Status	Control Status	Probable Cause	Service Procedure
Four flashes three second pause	Excessive tank temperature. System must be reset.	<ol style="list-style-type: none"> 1. Temperature sensor out of calibration. 2. Faulty gas control. 	Replace gas control
Five flashes and three second pause	Temperature sensor fault.	<ol style="list-style-type: none"> 1. Damage to the temperature sensor. 2. Temperature sensor resistance out of range. 	Replace gas control
Six flashes and three second pause	Water leak detected by accessory module	Excessive amount of water in drain pan/water dam.	<ol style="list-style-type: none"> 1. Check T&P valve. 2. Check all water fittings. 3. Pressurize and leak test tank.
Seven flashes and three second pause	Gas control electronic fault detected.	<ol style="list-style-type: none"> 1. Control needs to be reset. 2. Control is wet or physically damaged. 	<ol style="list-style-type: none"> 1. Reset gas control 2. Replace gas control.
Eight flashes and three second pause	Standing pilot remains on while setpoint knob is in "OFF" position.	Pilot valve stuck in open position.	Replace gas control

UDV Series

Troubleshooting V2

Observe colored LED indicator on electronic gas control. Status flash codes are displayed with a three second pause before repeating. Check and repair the system as noted in the troubleshooting table below.

LED colors:
Green-Normal operation
Yellow-Low thermopile voltage
Red-Valve fault

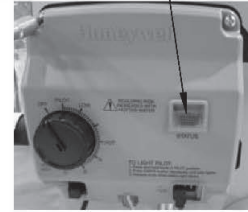

LED Status	Control Status	Probable Cause	Service Procedure
None (LED no on or flashing)	Millivolt power is not present. Light pilot.	Gas valve is functioning normally. Gas valve is not powered. Light pilot.	If the pilot will not stay lit replace pilot assembly. If problem persists, replace gas control.
One flash every four seconds (LED green)	Not an error. Indicates pilot is lit and main burner is off.	You can now turn the knob to a desired setpoint temperature	Normal operation.
One flash every second (LED green)	Not an error. Indicates main valve is open and main burner is lit.	None. Control will automatically shut main burner off when water temperature reaches the setpoint temperature.	Normal operation.
Two flashes (LED yellow)	Low thermopile voltage; main valve not turned ON.	Check thermopile and its connections. Check pilot flame.	1. See service procedure IV. 2. See service procedure II. 3. See service procedure II.
Four flashes (LED red)	Temperature cut-out limit reached.	Check the valves and the water temperature sensor. Reduce the water temperature setpoint. Thoroughly check out main valve operation and water temperature control before walking away.	Replace gas control
Five flashes (LED red)	Water temperature sensor failure.	Check water temperature sensor and its connection for open circuits, shorts, or differences in resistance between the two sensor elements.	Replace gas control
Six flashes (LED red)	Tank leakage detected by accessory module.	Control recovers after receiving message from accessory module.	4. Check T&P valve. 5. Check all water fittings. 6. Pressurize and leak test tank.
Solid ON (LED red)	Not an error-indicates that the control is in OFF mode.	None; wait until LED turns off if you want to restart system.	LED will go out and the control will function normally the pilot is lit.

UDV Series

UDV SERVICE PROCEDURE I Burner Operation Inspection, Cleaning and Replacement

Burner Inspection

At periodic intervals (every 6 months) a visual inspection should be made of the pilot and main burner for proper operation and to assure no debris is accumulating.

Pilot flame should be stable, some causes for an unstable pilot flame are:

- a) Water heater vent is less than the allowable vent length.
- b) Gas pressure is out of specification.
- c) Pilot flame not fully engulfing spark/flame sensor.

Main burner should light smoothly from pilot and burn with a blue flame with a minimum of yellow tips.

Main burner must be free from any debris accumulation that may affect burner operation (see burner cleaning procedure below).

Burner Cleaning

- Step 1. Position the gas control knob in the "OFF" position.
- Step 2. Turn off the gas supply to the water heater.
- Step 3. Disconnect the igniter wire from the gas control.
- Step 4. Disconnect the red and white pilot wires from the gas control.
- Step 5. Remove the outer jacket door. Remove the inner doors per service procedure VI on page 16.
- Step 6. Disconnect the pilot tube (7/16" wrench) from the gas control.
- Step 7. Disconnect the main feedline (3/4" wrench) from the gas control.
- Step 8. Remove the burner assembly from the combustion chamber.

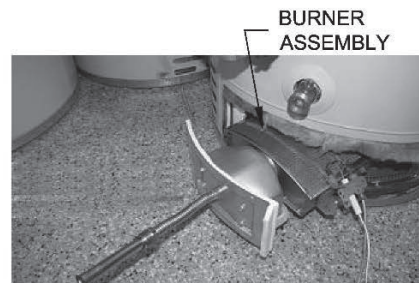
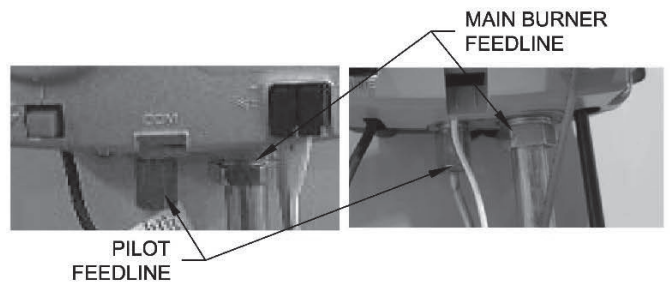
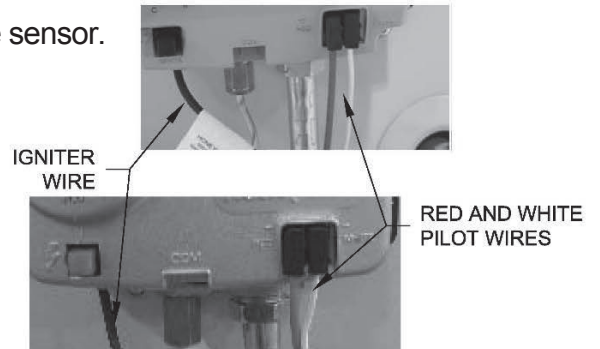

UDV Series

UDV SERVICE PROCEDURE I Burner Operation Inspection, Cleaning and Replacement

Burner Cleaning (cont.)

Step 9. Thoroughly inspect the burner surface area and the burner port area and remove any loose debris.

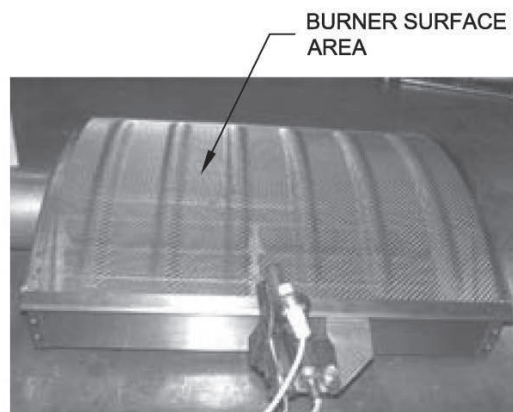

Step 10. Unscrew the burner feedline from the main burner inner door.

Step 11. Remove the main burner orifice from the feedline (1/2" wrench).

Step 12. Inspect the orifice, clean or replace if necessary.

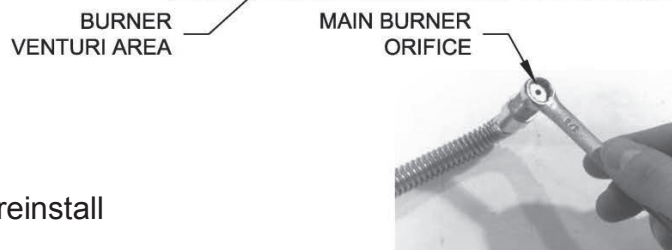
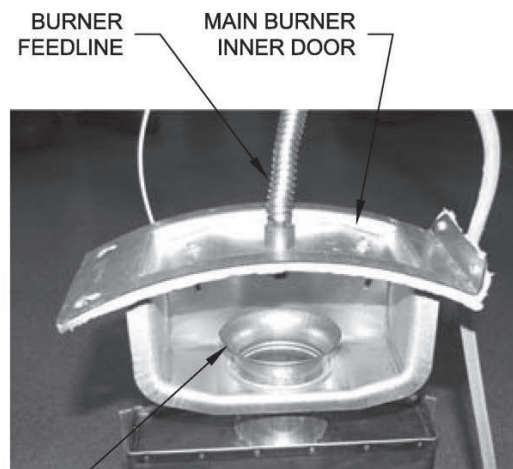

Step 13. Reassemble the burner and reinstall into the water heater.

Step 14. Restore the gas supply and check for any gas leaks.

Step 15. To resume operation, follow the instructions located on the lighting instruction label or the lighting instructions located in the installation and operation manual.

UDV Series

UDV SERVICE PROCEDURE II Pilot Testing, Cleaning & Replacement

Remove Burner to Gain Access to the Pilot

- Step 1. Position the gas control knob in the "OFF" position.
- Step 2. Turn off the gas supply to the water heater.
- Step 3. Remove the outer jacket door and inner doors per service procedure VI on page 16.
- Step 4. Disconnect the igniter wire from the gas control. Disconnect the red and white pilot wires from the gas control.
- Step 5. Disconnect the pilot tube (7/16" wrench) from the gas control.
- Step 6. Disconnect the main feedline (3/4" wrench) from gas control.

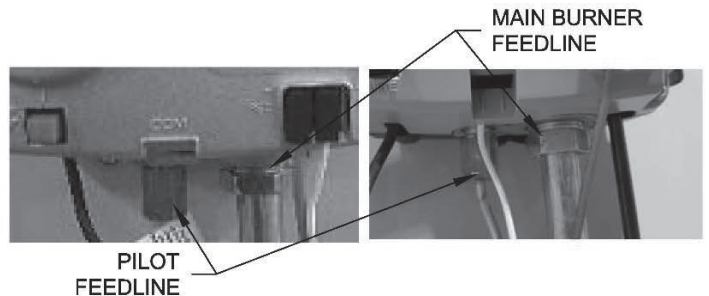
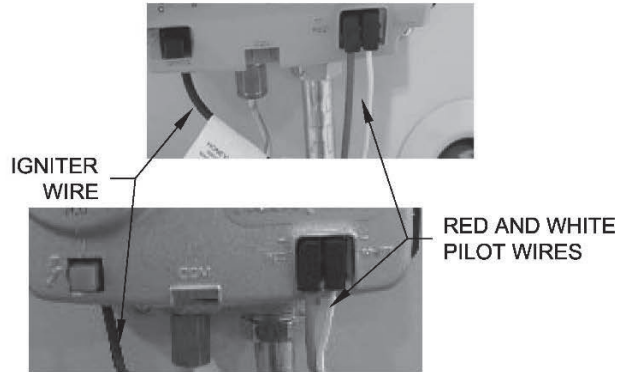

- Step 7. Remove the burner assembly from the combustion chamber.

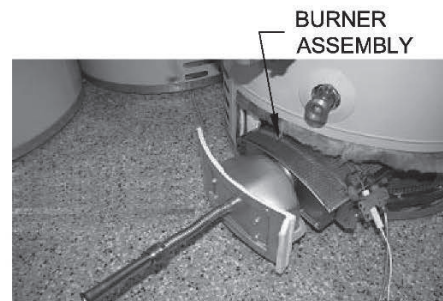

UDV Series

UDV SERVICE PROCEDURE II Pilot Testing, Cleaning & Replacement

Pilot Inspection, Testing and Replacement

- Step 1. Remove the pilot assembly from the burner (1/4" nut driver).
- Step 2. Visually inspect the igniter wire for damage. Replace pilot if damaged. Electrode should not be in contact with the pilot hood.
- Step 3. With a multi-meter set to ohms setting, check continuity through igniter wire. Replace pilot if no continuity.
- Step 4. Visually inspect igniter electrode for oxidation build up. Carefully clean any oxidation using a very fine emery cloth.
- Step 5. Visually inspect the pilot tubing for kinks or cracks. If damage is found, replace the pilot assembly.
- Step 6. Inspect the pilot tubing and the pilot orifice for blockage:
 - a. Remove the ferrule nut from the bottom of the pilot assembly (7/16" wrench).
 - b. Remove the pilot tube and pilot orifice.
 - c. Inspect the pilot tubing and orifice for blockage. Clean or replace as necessary.
- Step 7. Reassemble pilot and install onto the burner.
- Step 8. Reinstall the burner assembly into the water heater.
- Step 9. Restore the gas supply and check for any gas leaks.
- Step 10. To resume operation, follow the instructions located on the lighting instruction label or the lighting instructions located in the installation and operation manual.

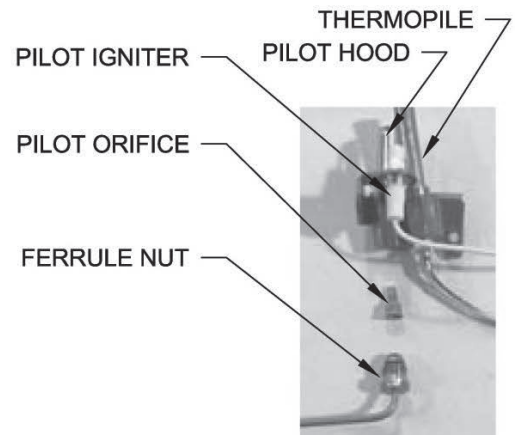
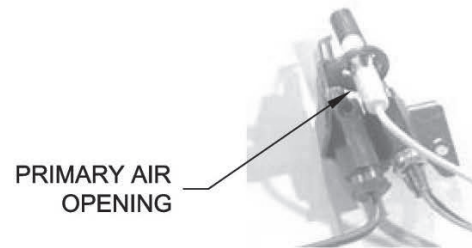
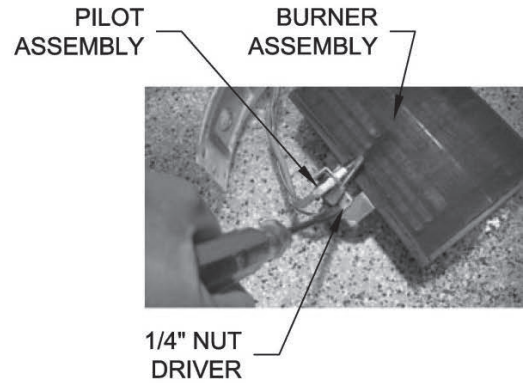

UDV Series

UDV SERVICE PROCEDURE III Gas Control Testing and Replacement

Line Pressure

The gas control is designed for a maximum line pressure of 14.0" W.C. and a minimum line pressure of 1.0" W.C. over the water heater's rated manifold pressure (check rating plate). Line pressure must be checked with the main burner on and off to assure proper readings.

Manifold Pressure Testing

(this procedure presumes a maximum line pressure of 14.0" w.c.)

- Step 1. Position the gas control knob in the "OFF" position.
- Step 2. Remove the pressure tap plug and install a 1/8" NPT pipe, coupling & pressure tap.
- Step 3. Connect a manometer to the pressure tap.
- Step 4. Follow instructions located on the lighting instruction label and proceed to light the main burner and observe the manometer readings.
- Step 5. Proper operating range for Natural Gas is 5.0" \pm 0.5" w.c.
- Step 6. If pressure is within the range specified in the previous step, set the Gas Control knob to the "OFF" position, remove manometer and pressure tap, and replace pressure tap plug.
- Step 7. Check for gas leaks prior to placing water instructions located on the lighting label, or the lighting instructions located in the installation and operation manual.
- Step 8. If the gas pressure is outside of the specification noted above, refer to the "Gas Control Testing and Replacement" to replace gas control on page 12.

GAS CONTROLS SHOWN IN THE "OFF" POSITION

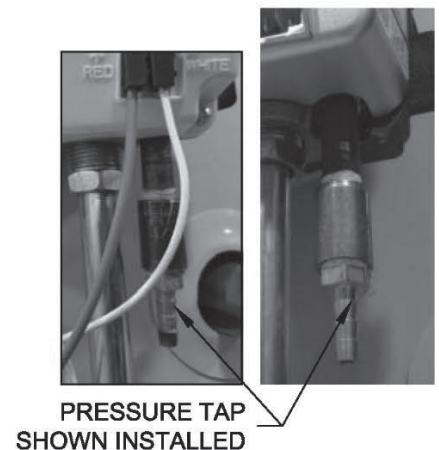
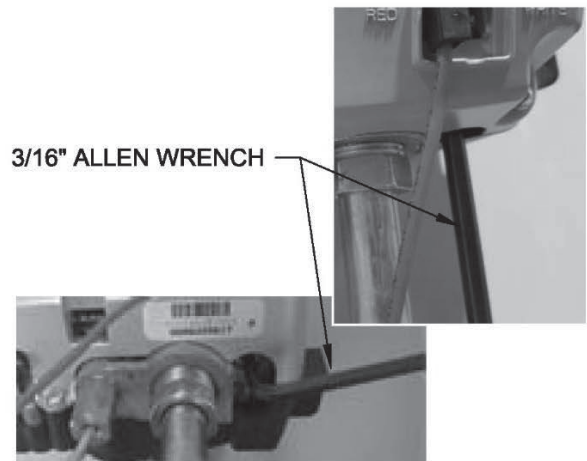
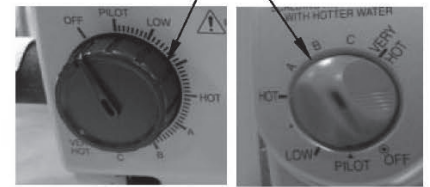

UDV Series

UDV SERVICE PROCEDURE III Gas Control Testing and Replacement

ECO (Energy Cut Out)

The Honeywell gas control is designed with an ECO device that will reset.

To reset the gas control after a status code (4), turn the gas control knob to the “OFF” position and wait a minimum of (5) minutes before relighting following the instructions located on the lighting instruction label or the lighting instructions located in the installation and operation manual.

Determine Water Temperature Inside Tank

⚠ WARNING

Stored water may be HOT WHEN PERFORMING THE FOLLOWING STEPS IN THIS PROCEDURE. Take necessary precaution to prevent personal injury.

- Step 1. Position the gas control knob to the “OFF” position.
- Step 2. Draw approximately 4 gallons of water from the drain valve into a container and discard.
- Step 3. Compare the measured water temperature with the setting on the gas control. In most instances, they should not differ by more than approx. 10°F.

UDV Series

UDV SERVICE PROCEDURE III Gas Control Testing and Replacement

Gas Control Removal from Water Heater

- Step 1. Position the gas control knob in the "OFF" position.
- Step 2. Drain the heater to a point below the gas control level.
- Step 3. Turn off the gas supply to the water heater and disconnect gas piping from the gas control.
- Step 4. Disconnect the igniter wire and the red and white pilot wires from the gas control.
- Step 5. Remove the outer jacket burner access door.

GAS CONTROL
SHOWN IN THE
"OFF" POSITION

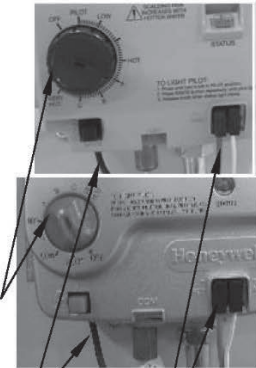

IGNITER
WIRE

RED AND WHITE
PILOT WIRES

- Step 6. Disconnect the pilot tube (7/16" wrench) from the gas control.
- Step 7. Disconnect the main feedline (3/4" wrench) from gas control.
- Step 8. Remove gas control from water heater by rotating counter clockwise. DO NOT use a wrench on the gas control body, damage to the Gas Control may occur. If necessary, use a length of 1/2" NPT pipe threaded into the gas inlet of gas control.

MAIN BURNER
FEEDLINE

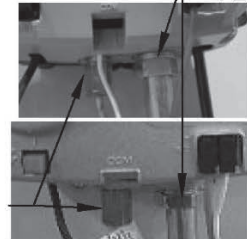

PILOT
FEEDLINE

- Step 9. Install new gas control into water heater by rotating clockwise. DO NOT use a wrench on the gas control body, damage to the Gas Control may occur. If necessary, use a length of 1/2" NPT pipe threaded into the gas inlet of the gas control.
- Step 10. Reattach the main burner feedline, pilot tube and pilot wires. Reattach igniter wire.
- Step 11. Reconnect gas supply and check for leaks.
- Step 12. To resume operation, follow the instructions located on the lighting instruction label or the lighting instructions located in the installation and operation manual.

Closed Circuit Thermopile Testing

Closed circuit thermopile testing is the preferred method for testing the thermopile.

- Step 1. Following the lighting instruction label on the heater, proceed to light the pilot and allow to operate for three minutes. If the pilot will not stay lit, hold the pilot button (rotate the gas control knob to the pilot position, push and hold in) during this test.

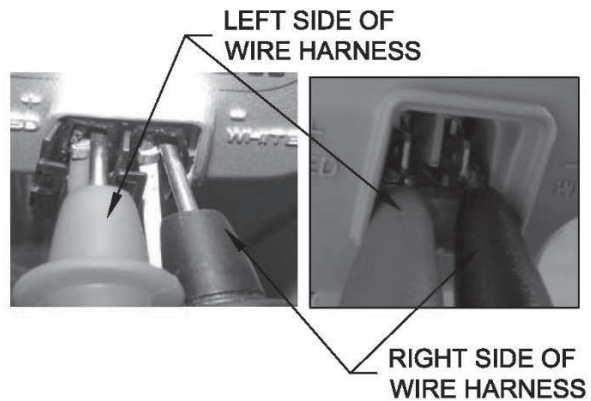

- Step 2. Using a multimeter capable of measuring millivolts, place one lead of the multimeter on the left side of the wire harness and place the second lead of the multimeter on the right side of the wire harness.
- Step 3. If meter reads 300 millivolts or higher, the thermopile is OK. If reading is below 300 millivolts, replace the pilot assembly per service procedure II on pages 9 & 10.

Open Circuit Thermopile Testing

- Step 1. Disconnect the red and white pilot wires from the gas control.
- Step 2. Using a multimeter capable of measuring millivolts, connect one lead to the red thermopile wire and one lead to the white thermopile wire.
- Step 3. Following the lighting instruction label on the heater, proceed to light the pilot and allow the heater to operate for three minutes. **It will be necessary to hold the gas control knob down in the "PILOT" position continuously throughout this test.** A reading over 400 millivolts indicates a good thermopile output.
- Step 4. A reading under 400 millivolts indicates a bad thermopile, replace the pilot assembly per service procedure II on pages 9 & 10.

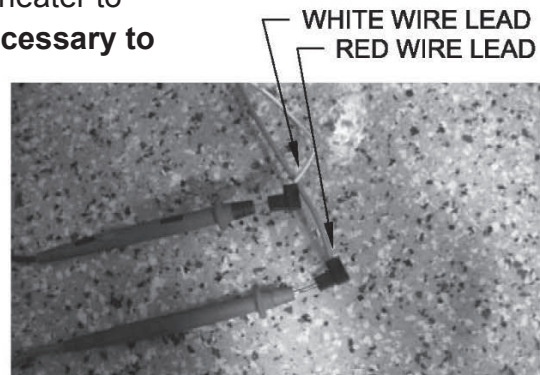

UDV Series

UDV SERVICE PROCEDURE V Igniter, Electrode Testing and Replacement

Igniter, Electrode Testing and Replacement

Step 1. Remove the outer jacket door.

Step 2. Repeatedly depress the igniter button while viewing the pilot through the flame viewing window. If a spark is present, the circuit is OK. If there is no spark, proceed to step 3.

Step 3. Remove the white wire from the gas control's igniter wire. Hold the igniter lead from the gas control to an unpainted surface such as the feedline and depress the igniter. If there is a spark, the igniter is OK. Otherwise, the igniter is not functioning and the pilot assembly must be replaced. See service procedure II on pages 9 & 10.

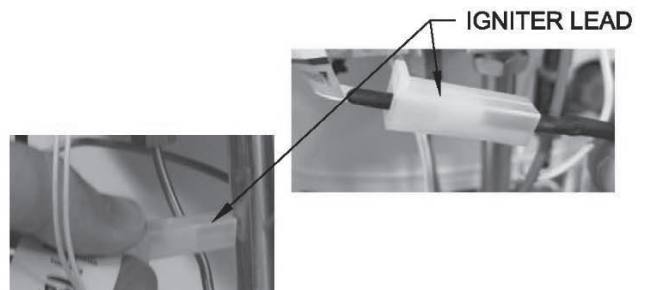
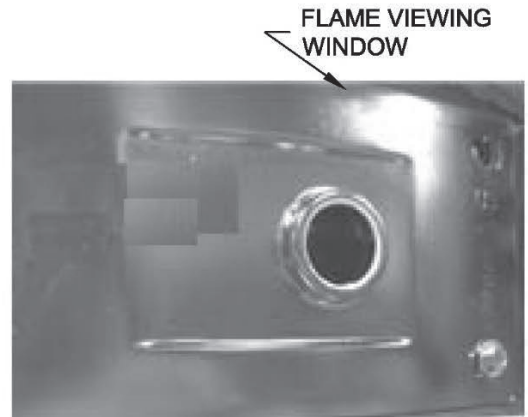
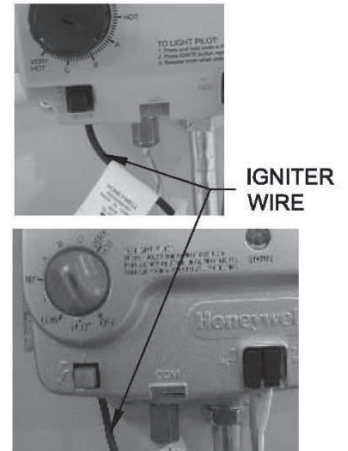

UDV Series

UDV SERVICE PROCEDURE VI Inner Door Removal and Replacement

Inner Door Removal Procedure

- Step 1. Position the gas control knob in the "OFF" position.
- Step 2. Remove the outer jacket burner access door.
- Step 3. Remove the wire clip from the feedline if present.
- Step 4. Remove (2) 1/4" hex drive screws from the right side inner door.
- Step 5. Remove (2) 1/4" drive screws from the flange section of the inner door.
- Step 6. Remove (3) 1/4" drive screws from the left side inner door.
- Step 7. Remove the inner doors.

(2) 1/4" HEX DRIVE SCREWS
RIGHT SIDE INNER DOOR



(2) 1/4" HEX DRIVE
SCREWS AT FLANGE
AREA OF INNER DOORS

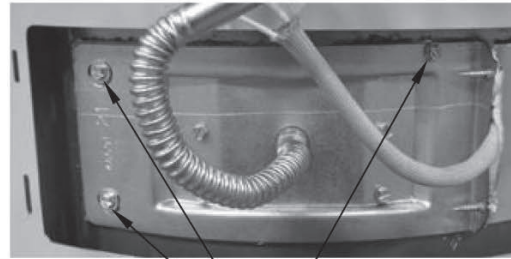

(3) 1/4" HEX DRIVE
SCREWS ON LEFT SIDE
INNER DOOR

- Step 8. Fully inspect inner door gaskets for the following:
- Tears
 - Missing Material
 - Cracks
 - Dirt or debris
 - Other imperfections that will inhibit proper seal
 - Gasket adhesion to inner door
 - Material left on combustion chamber (around opening)

If the gasket is not effected by any of the above, gasket replacement is not required. If replacement is required, proceed to **Inner Door Gasket Replacement Procedure**.

Inner Door Gasket Replacement Procedure

⚠ WARNING

If the information in these instructions is not followed exactly, a fire or explosion may result causing property damage, personal injury or death.

- Step 9. After inspection of inner door as noted in step 8, completely remove gasket and adhesive residue from right and left side inner doors as needed.

UDV Series

UDV SERVICE PROCEDURE VI Inner Door Removal and Replacement

Inner Door Gasket Replacement Procedure (cont.)

Step 10. Use RTV sealant (recommended bead size 1/8") to secure the inner door gasket to the inner door sections (right & left). Refer to the illustrations on the next page for proper application. Note the overlap configuration in the flange area of the inner door. Set the flange section first, this will help to achieve the proper overlap position.

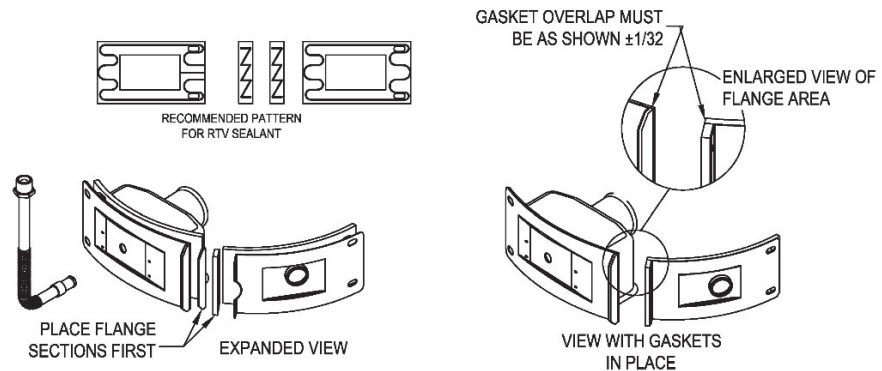

Installation of Inner Door with Gasket

- Step 11. Clean any residual gasket residue or other debris from combustion chamber surface before installing the inner door/gasket assembly.
- Step 12. Place the left side inner door and burner assembly into position first. Using the (3) 1/4" hex drive screws from step 6, secure left side inner door in place. **DO NOT OVER TIGHTEN SCREWS**
- Step 13. Position pilot tube and igniter/sensor wire against left side inner door flange gasket.
- Step 14. Firmly place right side inner door flange against the left side inner door flange and secure with (2) 1/4" hex drive screws from step 5. **DO NOT OVER TIGHTEN SCREWS.**

▲ WARNING

Stripped fastener connections may allow for seal breach of inner door. A seal breach may result in a fire or explosion causing property damage, personal injury or death. Do not over tighten screws in steps 12, 14 and 15.

1/4" DRIVE SCREWS
VERIFY THREADED HOLE ALIGNMENT WITH SLOTTED OPENINGS IN INNER DOOR

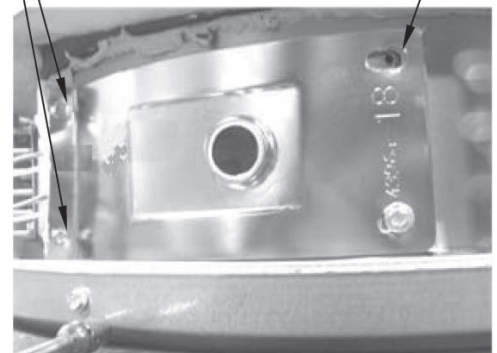

Installation of Inner Door with Gasket (cont.)

Step 15. Align right side inner door to combustion chamber and verify the fastener holes of the combustion chamber are aligned with right side inner door slotted opening. Verify seal integrity around combustion opening. Secure right side inner door using 1/4" hex drive screws from step 4. **DO NOT OVER TIGHTEN SCREWS.** Verify both left and right sides of inner door are properly positioned and sealed against the combustion chamber.

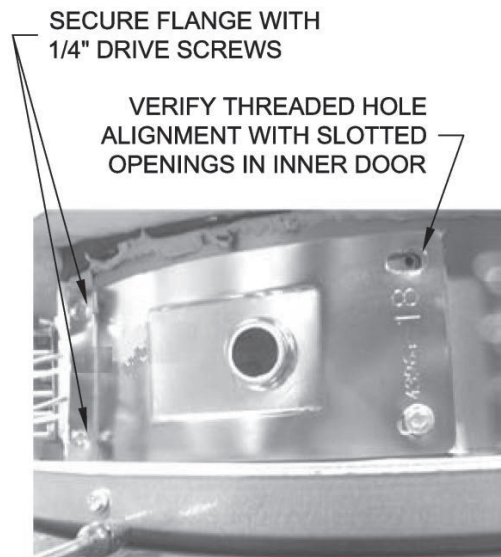

Step 16. Replace outer jacket burner access door.

Step 17. To resume operation, follow the instructions located on the lighting instruction label or the lighting instructions located in the installation and operation manual.

Diptube Inspection & Replacement

⚠ WARNING

Water Heater components and stored water may be **HOT** when performing the following steps in this procedure. Take necessary precaution to prevent personal injury.

- Step 1. Position the gas control knob in the “OFF” position.
- Step 2. Turn off the cold-water supply to the water heater.
- Step 3. Connect a hose to the drain valve of the water heater and route to an open drain.
- Step 4. Open a nearby hot water faucet to vent the water heater for draining.
- Step 5. Open the drain valve of the water heater and allow the heater to drain to a point below the inlet connection nipple.
- Step 6. Disconnect the inlet nipple from the plumbing system.
- Step 7. With an appropriate tool such as a pipe wrench, remove the inlet nipple/diptube from the water heater. Use caution not to damage any pipe threads.
- Step 8. Visually inspect the inlet nipple/diptube. The inlet nipple/diptube should be free of cracks and any blockage. Hydro jet slots should be open and free of any blockage. Any damage such as cracks, restriction due to deformation or unintentional holes are not field repairable and the inlet nipple/diptube must be replaced.
- Step 9. Upon completion of inspection or subsequent replacement, re-install the inlet nipple/diptube into the water heater. Ensure pipe dope is used on the nipple’s threads. Connect the nipple/diptube to the plumbing system and resume the water supply to refill with water.
- Step 10. To resume operation, follow the instructions located on the lighting instruction label or the lighting instructions located in the installation and operation manual.

Anode Inspection & Replacement

⚠ WARNING

Water Heater components and stored water may be HOT when performing the following steps in this procedure. Take necessary precaution to prevent personal injury.

- Step 1. Position the gas control knob in the “OFF” position.
- Step 2. Turn off the cold-water supply to the water heater.
- Step 3. Connect a hose to the drain valve of the water heater and route it to an open drain.
- Step 4. Open a nearby hot water faucet to vent the water heater for draining.
- Step 5. Open the drain valve of the water heater and allow the water heater to drain to a point below the outlet connection nipple.
- Step 6. Disconnect the outlet nipple from the plumbing system.
- Step 7. With an appropriate tool such as a pipe wrench, remove the outlet nipple/anode from the water heater. Use caution not to damage the pipe threads.
- Step 8. Visually inspect the outlet nipple/anode. The outlet nipple/anode should show signs of depletion, this is normal. If the depletion is $\frac{1}{2}$ of the original anode diameter (approximately $\frac{3}{4}$ ” diameter), replacement is recommended. If any of the steel core of the anode is exposed, replacement is recommended.
- Step 9. Upon completion of the inspection or subsequent replacement, re-install outlet nipple/anode into the water heater. Ensure pipe dope is used on the nipple’s threads. Connect the nipple to the plumbing system, resume water supply and refill with water.
- Step 10. To resume operation, follow the instructions located on the lighting instruction label or the lighting instructions located in the installation and operation manual.

Glossary of Terms

BTU	British Thermal Units
GPM	Gallons per Minute
Hz	Hertz
wh	Kilowatt Hour
LED	Light Emitting Diode
NPT	National Pipe Thread
Ohms	Ohms of resistance
PSI	Pounds per Square Inch
RPM	Revolutions per minute
ECO	Energy Cut Out
VAC	Volts Alternating Current
“W.C.	Inches of Water Column
°C	Degrees Centigrade
°F	Degrees Fahrenheit

UDV Series

Parts List

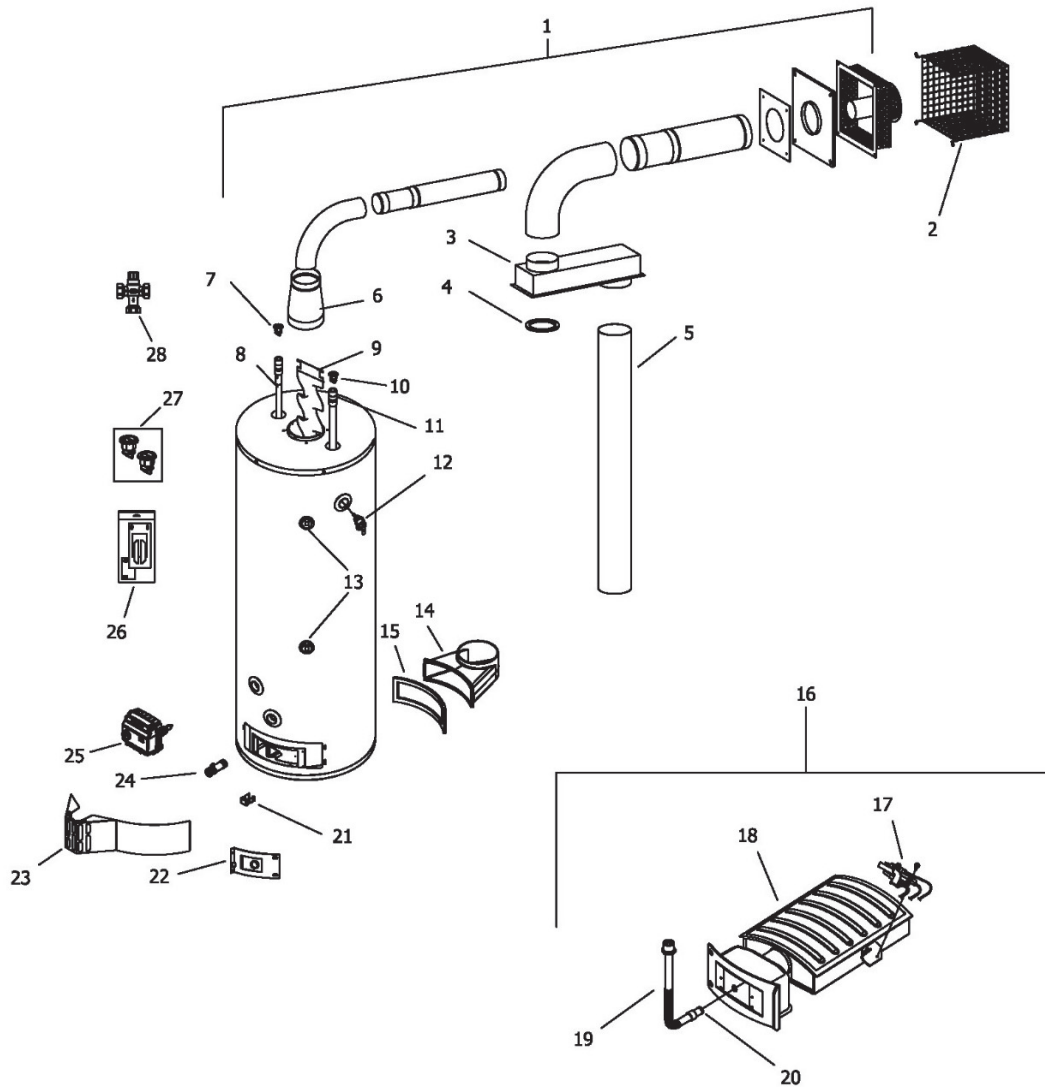

- | | | |
|------------------------------|------------------------------------|--------------------------------|
| 1. Venting Package Complete | 10. Heat Trap Inlet | 20. Main Burner Orifice |
| 2. Venting Protection Screen | 11. Inlet Diptube | 21. Feedline Clip |
| 3. Plenum | 12. T&P Valve | 22. Right Side Inner Door |
| 4. Plenum Gasket | 13. 1/4 NPT Plug ("H" Models only) | 23. Outer Door |
| 5. Rear Air Intake Tube | 14. Air Intake Boot | 24. Brass Drain Valve |
| 6. Flue Reducer | 15. Air Intake Boot Gasket | 25. Gas Control |
| 7. Heat Trap Outlet | 16. Burner Assy. Complete | 26. Inner Door Gasket Kit |
| 8. Anode Outlet Device | 17. Pilot Assy. | 27. Kit-Heat Trap Insert |
| 9. Flue Baffle | 18. Main Burner | 28. ASSE Approved Mixing Valve |
| | 19. Feedline | |



United States

Sales 800-523-2931

Technical Support 800-334-3393

Email techserv@bradfordwhite.com

Warranty 800-531-2111

Email warranty@bradfordwhite.com

Service Parts 800-538-2020

Email parts@bradfordwhite.com

Canada

Sales & Technical Support 866-690-0961 905-203-0600

Fax 905-636-0666

Warranty bwccwarranty@bradfordwhite.com

Technical Support bwccotech@bradfordwhite.com

Service Parts orders@bradfordwhitecanada.com

Orders ca.orders@bradfordwhite.com

For U.S. and Canada field service,
contact your professional installer or
local Bradford White sales representative.

International

General Contact international@bradfordwhite.com