



# Service Light Duty Commercial Electric Replacement Parts List

## Service Light Duty Energy Saver SLE Models



**Models Covered:**  
**SLE2(65,80,120)T\***  
\*Denotes warranty year

Includes Hydrojet®  
Total Performance System

**Effective: October, 2024**  
**ECO 8780**

**NOTE: BOTH MODEL AND SERIAL  
NUMBERS ARE REQUIRED FOR  
ORDERING REPLACEMENT PARTS**

Dimensions and specifications  
subject to change without notice.

**WARNING**  
CANCER AND REPRODUCTIVE HARM  
[WWW.P65WARNINGS.CA.GOV](http://WWW.P65WARNINGS.CA.GOV)

As required by the state of California Proposition 65.

**TOP LOCATION**

- Double element water heater.

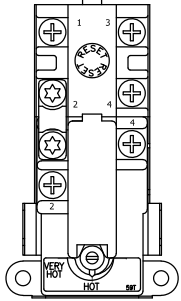

59T66T

**BOTTOM LOCATION**

- Single element water heater.
- Double element water heater.

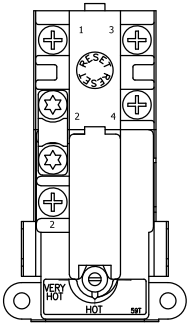

59T66T

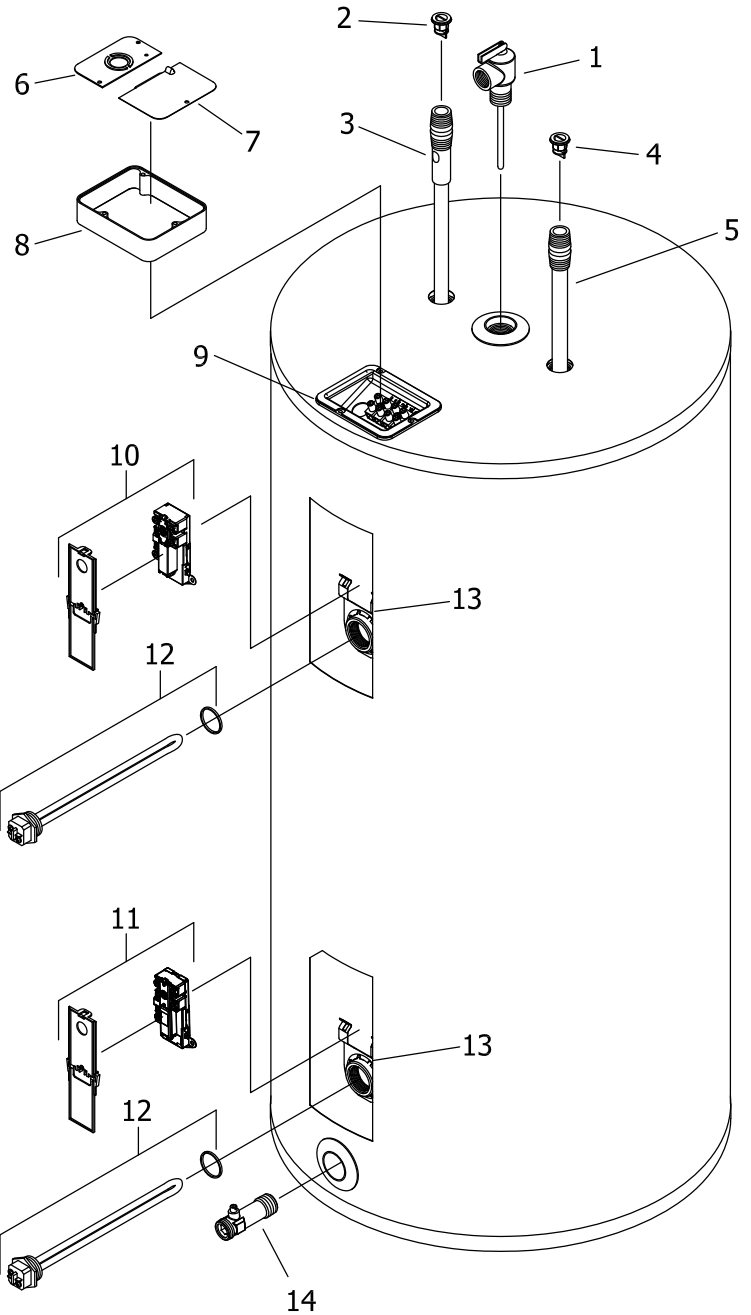
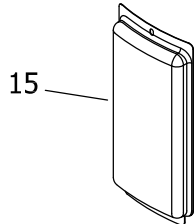
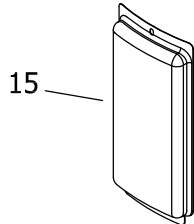
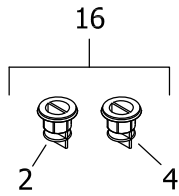
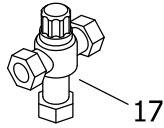

Item	Description	Model	Model	Model
		SLE265T	SLE280T	SLE2120T
1	T&P Relief Valve	415-40594-02	415-40594-02	415-40594-02
2	Heat Trap Insert (Outlet)	415-45167-00	415-45167-00	415-45167-00
3	Hot Water Outlet Anode Magnesium ♦ #	415-55482-00	415-55482-00	224-47780-01
	Aluminum ♦ #	415-55484-00	415-55484-00	224-45036-01
	A420 (Aluminum)#	415-55486-00	415-55486-00	---
4	Heat Trap Insert (Inlet)	415-51556-00	415-51556-00	415-51556-00
5	Cold Water Inlet Tube PEX ♦♦	415-51230-22	229-51230-33	---
	Cold Water Inlet Tube Polysulfone ♦♦	---	---	229-45032-01
6	Cover Conduit/Ground	239-39451-00	239-39451-00	239-39451-00
7	Cover Junction Box	243-39452-00	243-39452-00	243-39452-00
8	Junction Box Extender	239-40587-00	239-40587-00	239-40587-00
9	J-Box w/ Terminal Block	265-47380-00	265-47380-00	265-47380-00
10	Upper Thermostat (59T66T) & Protector ▲	415-50692-00	415-50692-00	415-50692-00
11	Lower Thermostat (59T66T) & Protector ▲	415-50691-00	415-50691-00	415-50691-00
12	Heating Element 277V 6100W with Gasket*	415-42547-16	415-42547-16	415-42547-16
13	Thermostat Mounting Bracket	415-50689-00	415-50689-00	415-50689-00
14	Brass Drain Valve	415-42351-02	415-42351-02	415-42351-02
15	Access Cover	243-36618-02	243-36618-02	243-36618-02
16	Heat Trap Insert Kit (PEX)	265-51572-00	265-51572-00	265-51572-00
17	ASSE Approved Mixing Valve	239-51778-00	239-51778-00	239-51778-00

- ♦ Order with item 2.
- ♦♦ Order with item 4.
- ▲ Thermostat protector provided in kit with thermostat.
- # Anode may need to be cut to length, please see page 4 for reference chart of anode length by model.



## United States

---

**Sales** 1-800-523-2931  
**Technical Support** 1-800-334-3393  
**Email** [techsupport@bradfordwhite.com](mailto:techsupport@bradfordwhite.com)  
**Warranty** 1-800-531-2111  
**Email** [warranty@bradfordwhite.com](mailto:warranty@bradfordwhite.com)  
**Service Parts** 1-800-538-2020  
**Email** [parts@bradfordwhite.com](mailto:parts@bradfordwhite.com)

## Canada

---

**Sales** 1-866-690-0961 1-905-203-0600  
**Fax** 905-636-0666  
**Warranty** 1-800-531-2111  
**Email** [warranty@bradfordwhite.com](mailto:warranty@bradfordwhite.com)  
**Technical Support** 1-800-334-3393  
**Email** [techsupport@bradfordwhite.com](mailto:techsupport@bradfordwhite.com)  
**Service Parts and Orders** [ca.orders@bradfordwhite.com](mailto:ca.orders@bradfordwhite.com)

For U.S. and Canada field service, contact your professional installer or local Bradford White sales representative.

## International

---

**General Contact** [international@bradfordwhite.com](mailto:international@bradfordwhite.com)